

LSM Experiments meeting News and Updates

Organization

- **Arnaud Lucotte** is stepping down as Director of LPSC
 - → IN2P3 Deputy Scientific Director (Accelerator, Detectors and technology)
- **Laurent Derome** : Interim LPSC Director
- **LSM manpower**
 - Michel Zampaolo officially retired in April 2021
 - Martin De Raphelis Soissan : Software engineer (Oct 2021)
 - No candidate for the senior technician temporary position (computer/network)

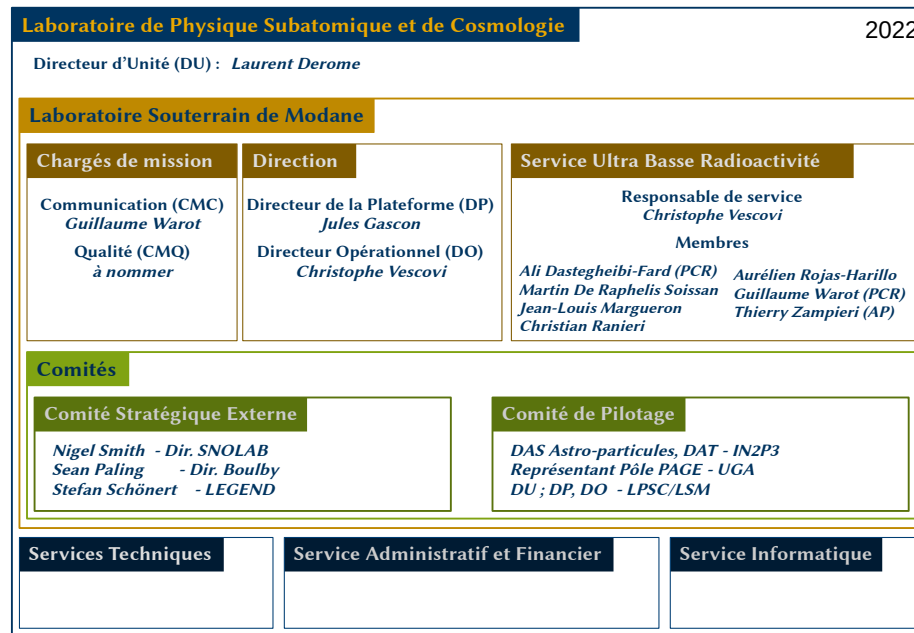

- LSM part of 2022 French Research Infrastructure Roadmap
- CPER (State/Region funding program)
 - LSM-UP project in the regional priority list
 - Final decision to be expected in the following months
- COVID
 - Very limited impact in 2021
 - Strong impact at this beginning of year 2022
 - Virus circulation in Modane is high
 - Team organization to prevent contacts
 - Telework when possible

Infrastructures

- Reception of DAMIC-M Detector Clean Room (Feb 2021)
 - Some non-conformity corrected
 - Correction of the cooling system in May



- PARTAGe
 - 8 detector installed (+ 3 shielding ready) on the first raw
 - Still waiting for the first Marinelli shieldings (second raw)
 - Installation must be completed in 2022



- Radon trapping
 - Refrigeration system out-of-order since Nov 2021
 - In-house design needed to reduce power consumption and cost
 - Study and schematics of refrigeration SKID done
 - Components ordered (end 2021) and are being delivered
 - Slow control and instrumentation subcontracted to external company
 - Final mechanical design and manufacturing to be complete @ LPSC

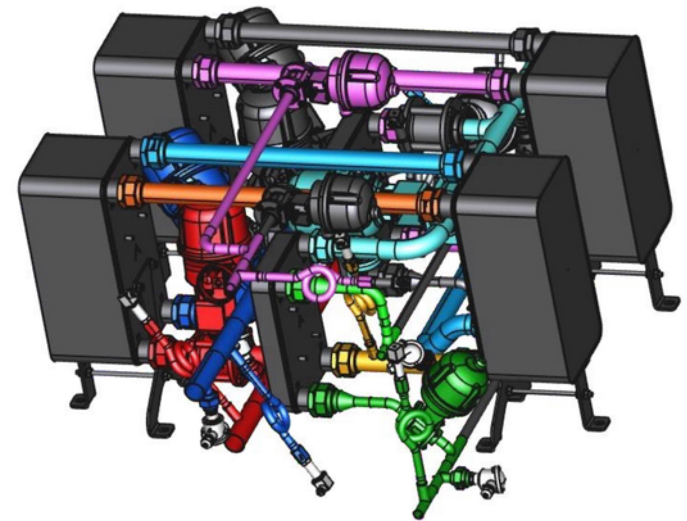
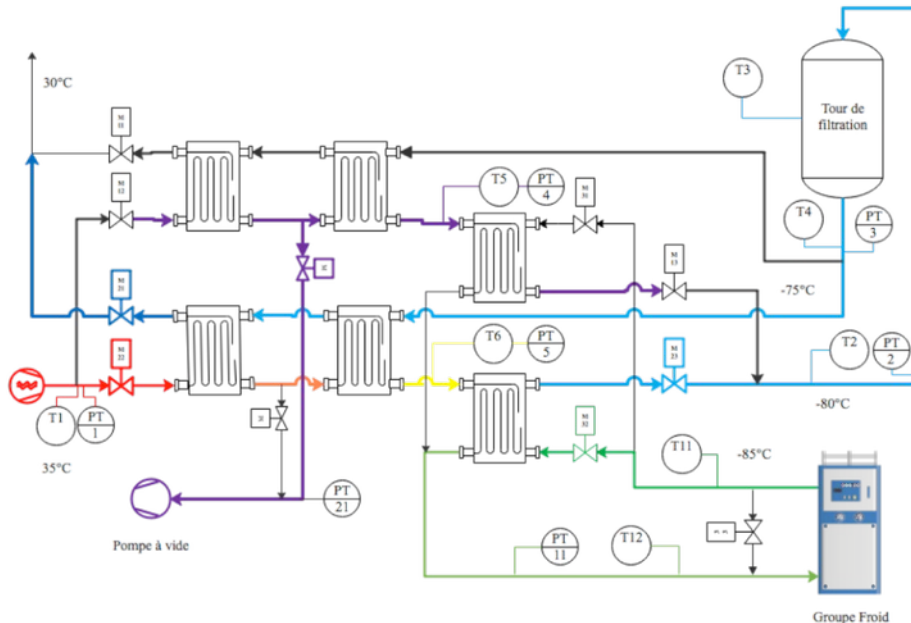

- Radon trapping in 2022
 - Tender for main refrigeration unit (Jan.)
 - Delivery lead time unknown
 - SKID manufacturing and commissioning of complete refrigeration system
 - Compressor and dryer replacement
- Budget is secured
- Planning uncertainties
 - Lead times
 - Tender delays

Infrastructures

- Platform Clean-Room
 - A new larger clean room has to be build in place of the actual platform clean-room
 - BINGO
 - DAMIC-M : Packaging/Testing
 - Biology, ...

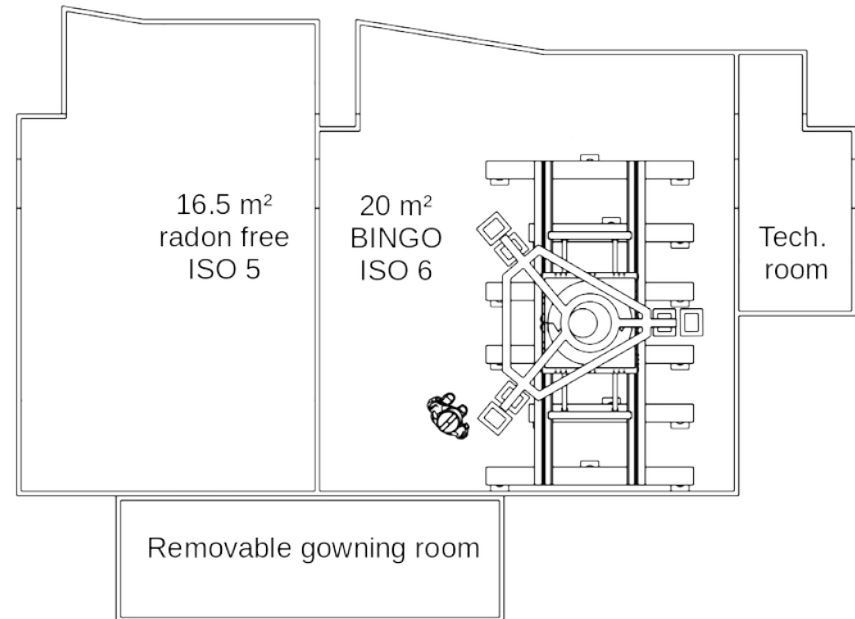
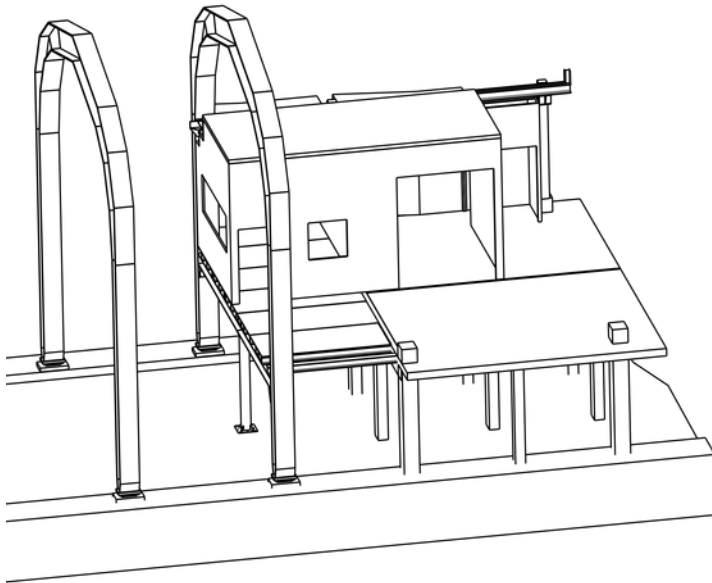

Infrastructures

- Platform Clean-Room
- Tender to issue in 2022
- Estimated cost : 270 k€

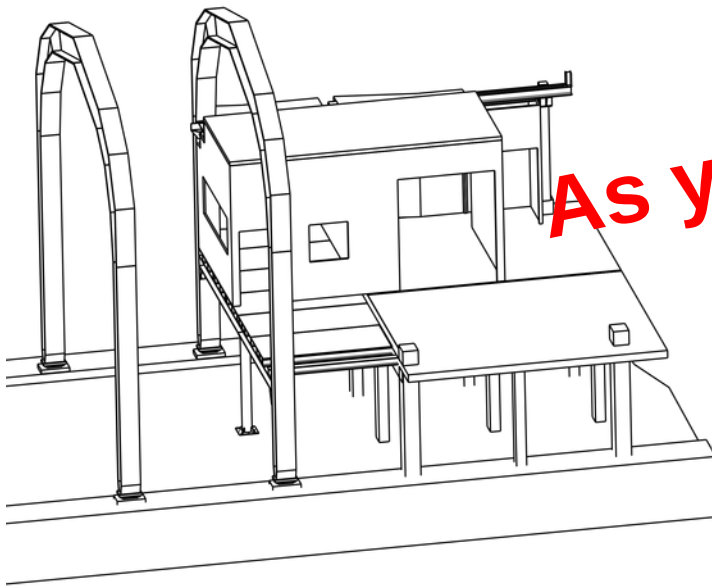

As yet, no budget

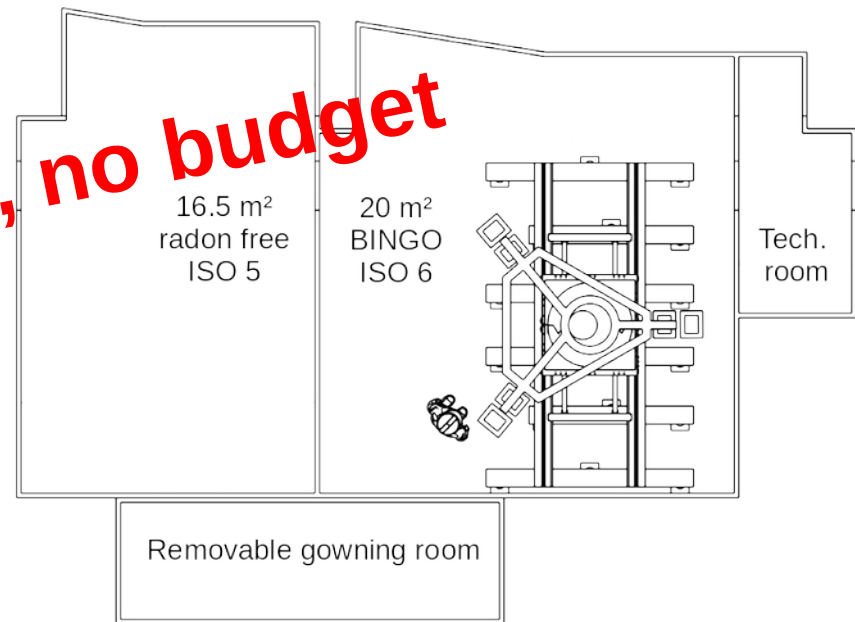

- Lots of infrastructure work to be done in 2022 !!
 - Radon trapping facility
 - PARTAGe
 - Platform Clean Room
 - Disassembly of the actual clean room
 - Disassembly of SEDINE
 - Disassembly of the 1.2T crane
- CPER results expected in 2022
 - More infrastructure work for the under-vault platform
 - Most likely in 2013
 - Budget availability
 - Final studies, tender ...
- Support to project activities, mainly :
 - SuperNEMO : antiradon tent, iron shielding
 - DAMIC-M
 - BINGO