

TOWARDS HIGGS AND Z BOSON PLUS JET DISTRIBUTIONS AT NLL/NLO⁺

Francesco Giovanni Celiberto, UAH Madrid

In collaboration with: Luigi Delle Rose, Michael Fucilla, Gabriele Gatto, Alessandro Papa

Grenoble



2024, April 9th



Higgs production from LHC to FCC

PHYSICAL REVIEW LETTERS **120**, 202003 (2018)

Double Resummation for Higgs Production

Marco Bonvini^{1,*} and Simone Marzani^{2,†}

¹INFN, Sezione di Roma 1, Piazzale Aldo Moro 5, 00185 Roma, Italy

²Dipartimento di Fisica, Università di Genova and INFN, Sezione di Genova, Via Dodecaneso 33, I-16146 Genova, Italy

 (Received 26 February 2018; published 16 May 2018)

We present the first double-resummed prediction of the inclusive cross section for the main Higgs production channel in proton-proton collisions, namely, gluon fusion. Our calculation incorporates to all orders in perturbation theory two distinct towers of logarithmic corrections which are enhanced, respectively, at threshold, i.e., large x , and in the high-energy limit, i.e., small x . Large- x logarithms are resummed to next-to-next-to-next-to-leading logarithmic accuracy, while small- x ones to leading logarithmic accuracy. The double-resummed cross section is furthermore matched to the state-of-the-art fixed-order prediction at next-to-next-to-next-to-leading accuracy. We find that double resummation corrects the Higgs production rate by 2% at the currently explored center-of-mass energy of 13 TeV and its impact reaches 10% at future circular colliders at 100 TeV.

DOI: [10.1103/PhysRevLett.120.202003](https://doi.org/10.1103/PhysRevLett.120.202003)

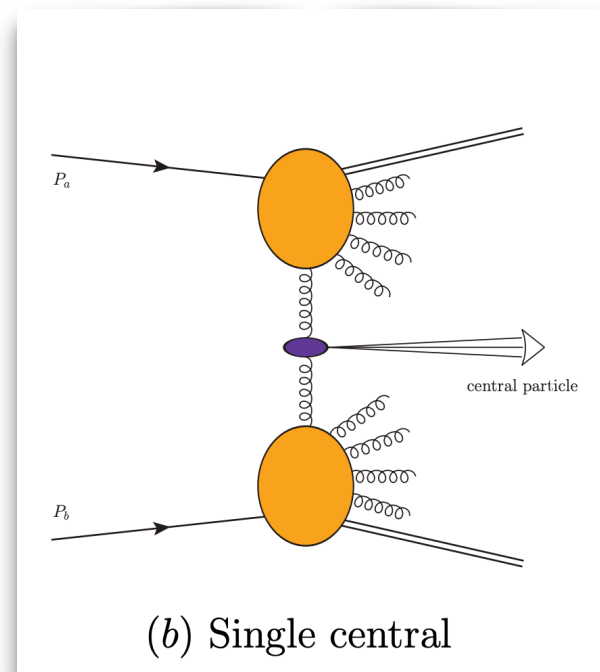

High-energy resummation (BFKL) \Rightarrow PDFs at small- x 

Altarelli-Ball-Forte  to stabilize the NLL_{sx} BFKL kernel 

$N^3LL_{lx}/LL_{sx}/N^3LO$ rapidity-inclusive coefficient functions

$$C_{ij}(x, \alpha_s) = C_{ij}^{fo}(x, \alpha_s) + \Delta C_{ij}^{lx}(x, \alpha_s) + \Delta C_{ij}^{sx}(x, \alpha_s)$$

Higgs production from LHC to FCC

PHYSICAL REVIEW LETTERS **120**, 202003 (2018)

Double Resummation for Higgs Production

Marco Bonvini^{1,*} and Simone Marzani^{2,†}

¹INFN, Sezione di Roma 1, Piazzale Aldo Moro 5, 00185 Roma, Italy

²Dipartimento di Fisica, Università di Genova and INFN, Sezione di Genova, Via Dodecaneso 33, I-16146 Genova, Italy

(Received 26 February 2018; published 16 May 2018)

We present the first double-resummed prediction of the inclusive cross section for the main Higgs production channel in proton-proton collisions, namely, gluon fusion. Our calculation incorporates to all orders in perturbation theory two distinct towers of logarithmic corrections which are enhanced, respectively, at threshold, i.e., large x , and in the high-energy limit, i.e., small x . Large- x logarithms are resummed to next-to-next-to-next-to-leading logarithmic accuracy, while small- x ones to leading logarithmic accuracy. The double-resummed cross section is furthermore matched to the state-of-the-art fixed-order prediction at next-to-next-to-next-to-leading accuracy. We find that double resummation corrects the Higgs production rate by 2% at the currently explored center-of-mass energy of 13 TeV and its impact reaches 10% at future circular colliders at 100 TeV.

DOI: 10.1103/PhysRevLett.120.202003

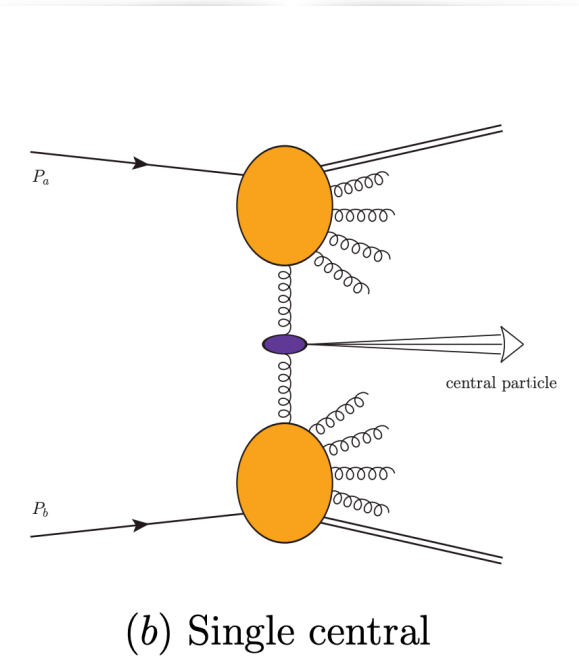
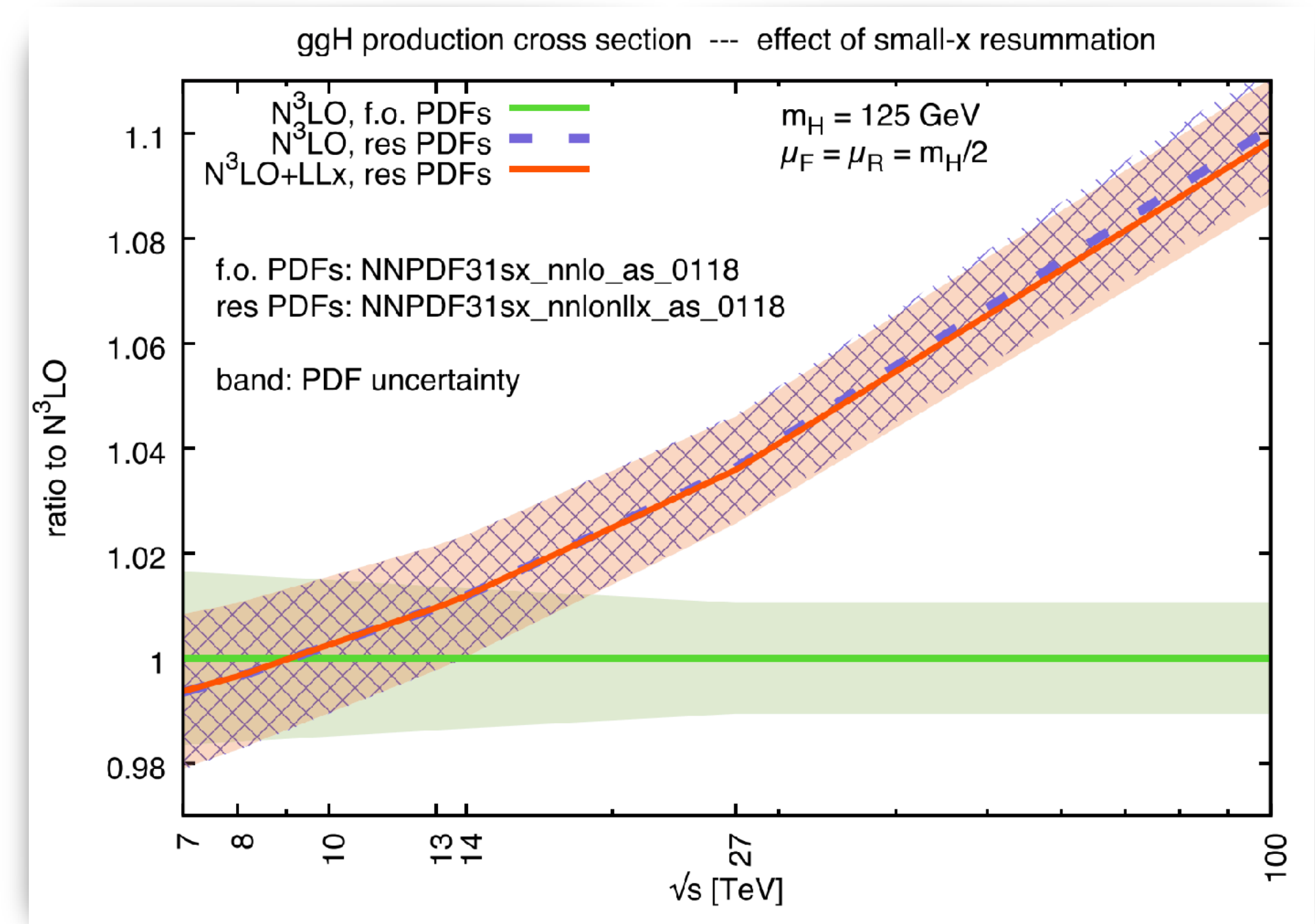

High-energy resummation (BFKL) \Rightarrow PDFs at small- x

Altarelli-Ball-Forte to stabilize the NLL_{sx} BFKL kernel

$N^3LL_{lx}/LL_{sx}/N^3LO$ rapidity-inclusive coefficient functions

(i!) 100 TeV EW physics \Leftrightarrow small- x physics!

(c?) Can LHC physics be BFKL physics?

$$C_{ij}(x, \alpha_s) = C_{ij}^{fo}(x, \alpha_s) + \Delta C_{ij}^{lx}(x, \alpha_s) + \Delta C_{ij}^{sx}(x, \alpha_s)$$

From Mueller-Navelet to Higgs and heavy flavor

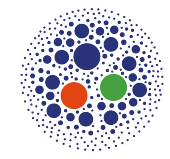

Pheno path: hunt for channels leading to a NLL **stabilization pattern** at **natural scales** (!)

HIGGS BOSON

Stabilizers \Leftrightarrow large Higgs transverse masses

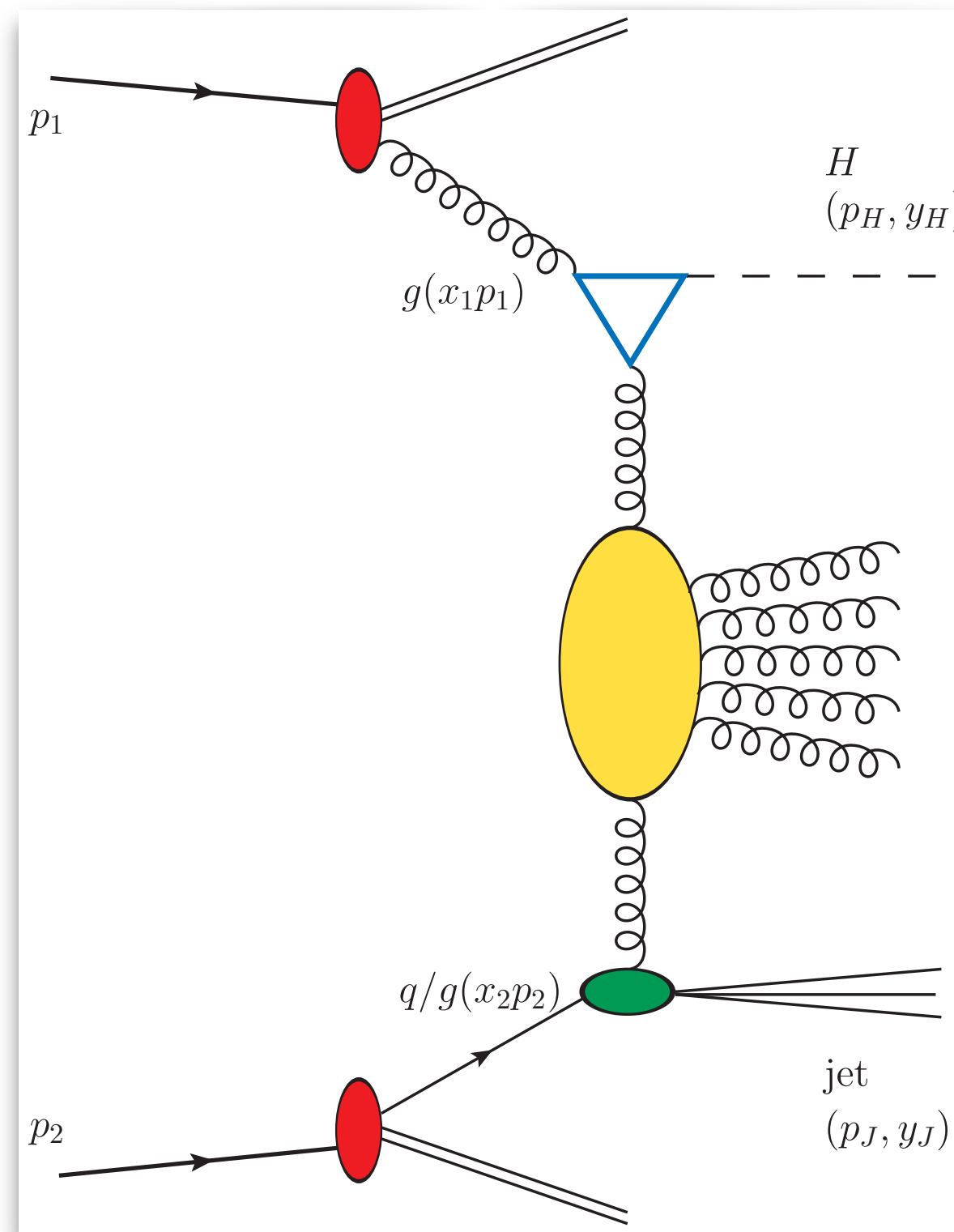

(Higgs + jet, NLL/NLO*) [\[F. G. C. et al., Eur. Phys. J. C \(2021\) 8, 780\]](#)

(NLO Higgs emission function) [\[F. G. C., M. Fucilla et al., JHEP 08 \(2022\) 092\]](#)

From Mueller-Navelet to Higgs and heavy flavor

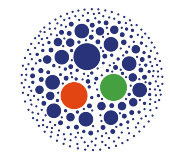

Pheno path: hunt for channels leading to a NLL **stabilization pattern** at **natural scales** (!)

HIGGS BOSON

Stabilizers \Leftrightarrow large Higgs transverse masses

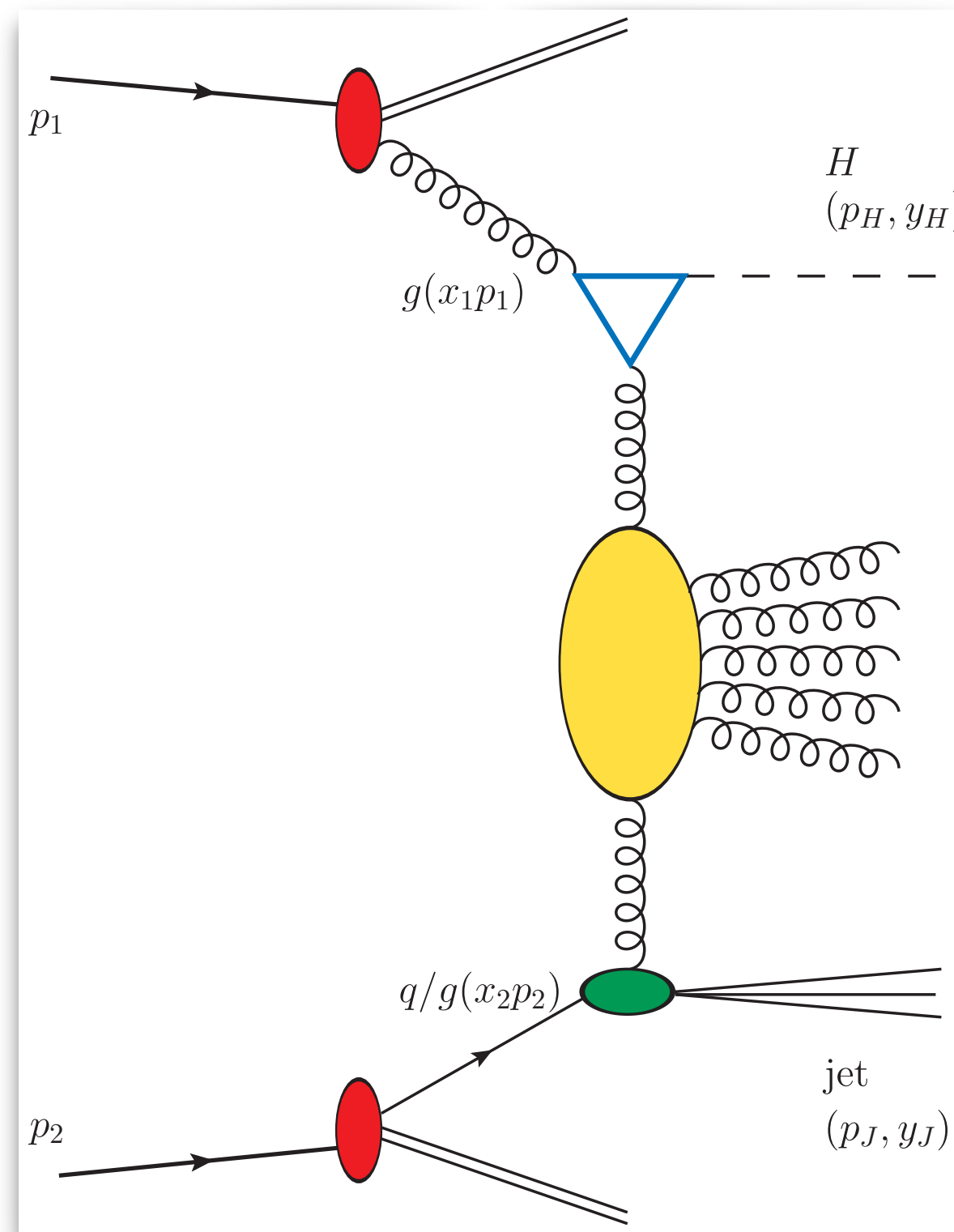

HEAVY FLAVOR AT LARGE P_T

Stabilizers \Leftrightarrow gluon fragmentation channels

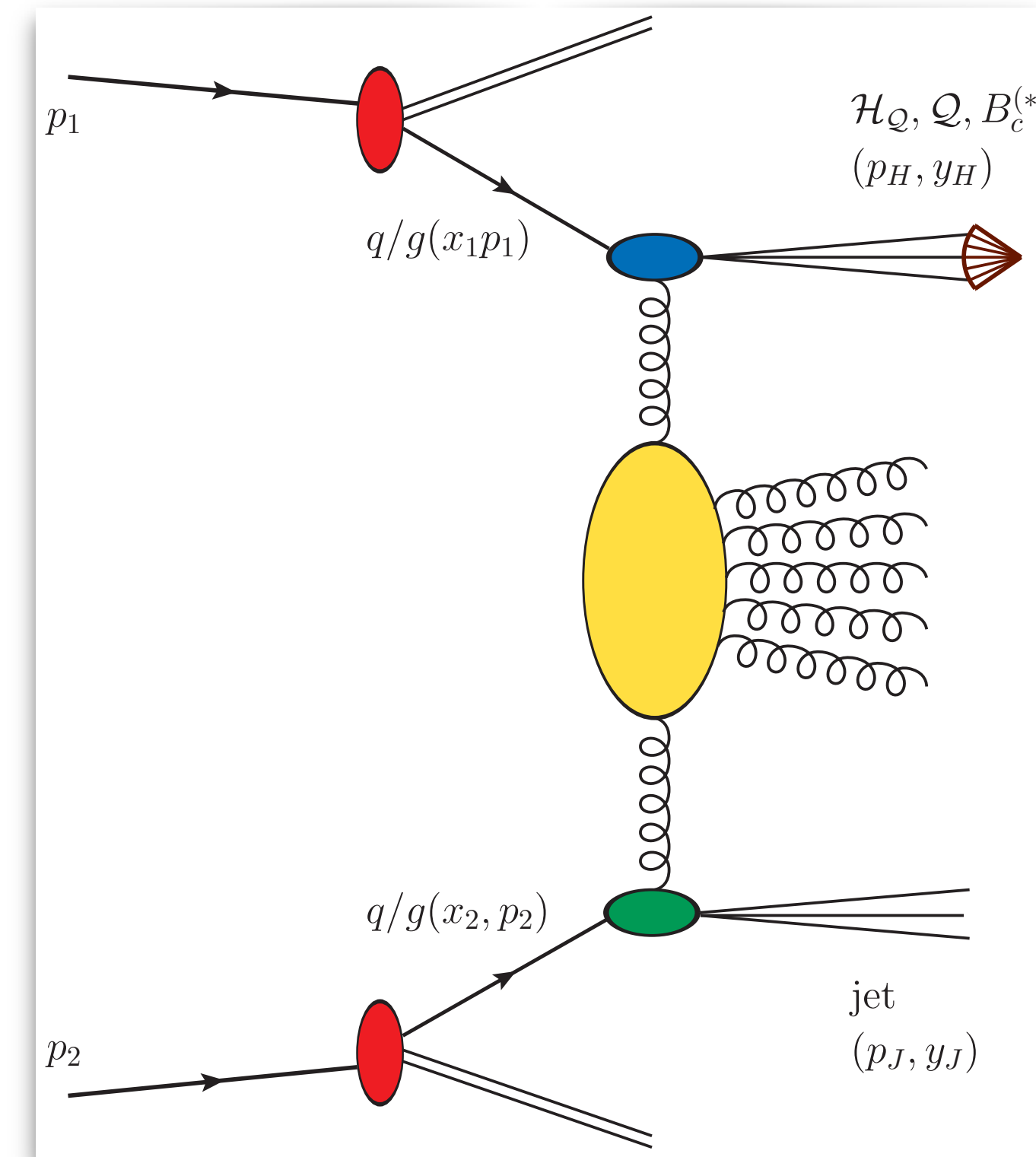

(Higgs + jet, NLL/NLO*) \otimes [F. G. C. et al., Eur. Phys. J. C (2021) 8, 780]

(NLO Higgs emission function) \otimes [F. G. C., M. Fucilla et al., JHEP 08 (2022) 092]

(Λ_c^\pm baryons, NLL/NLO) \otimes [F. G. C. et al., Phys. Rev. D 104 (2021) 11, 114007]

(J/ψ or Υ , NLL/NLO) \otimes [F. G. C. et al., Eur. Phys. J. C 82 (2022) 10, 929]

($B_c^\pm(1S_0)$ or $B_c^{*\pm}(3S_1)$, NLL/NLO) \otimes [F. G. C., Phys. Lett. B 835 (2022) 137554]

From Mueller-Navelet to Higgs and heavy flavor

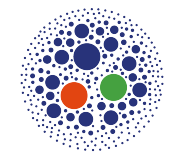

Pheno path: hunt for channels leading to a NLL stabilization pattern at natural scales (!)

HIGGS BOSON

Stabilizers \Leftrightarrow large Higgs transverse masses

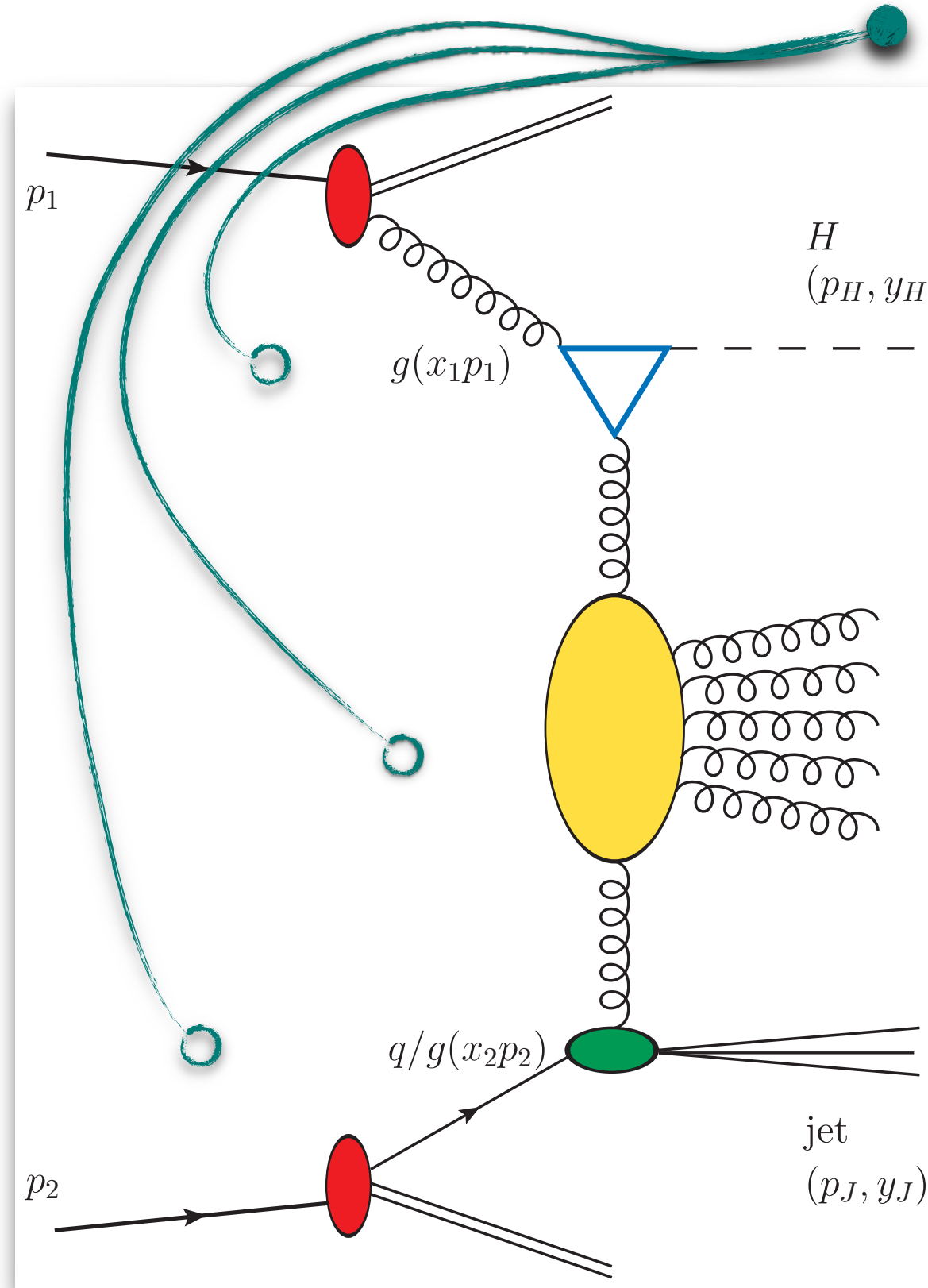

$$\mu_{F,R} \sim M_{H,\perp}$$

NLO*

$$= \text{LO} + \text{NLO}_{\text{RG}}$$

NLL

NLO

HEAVY FLAVOR AT LARGE P_T

Stabilizers \Leftrightarrow gluon fragmentation channels

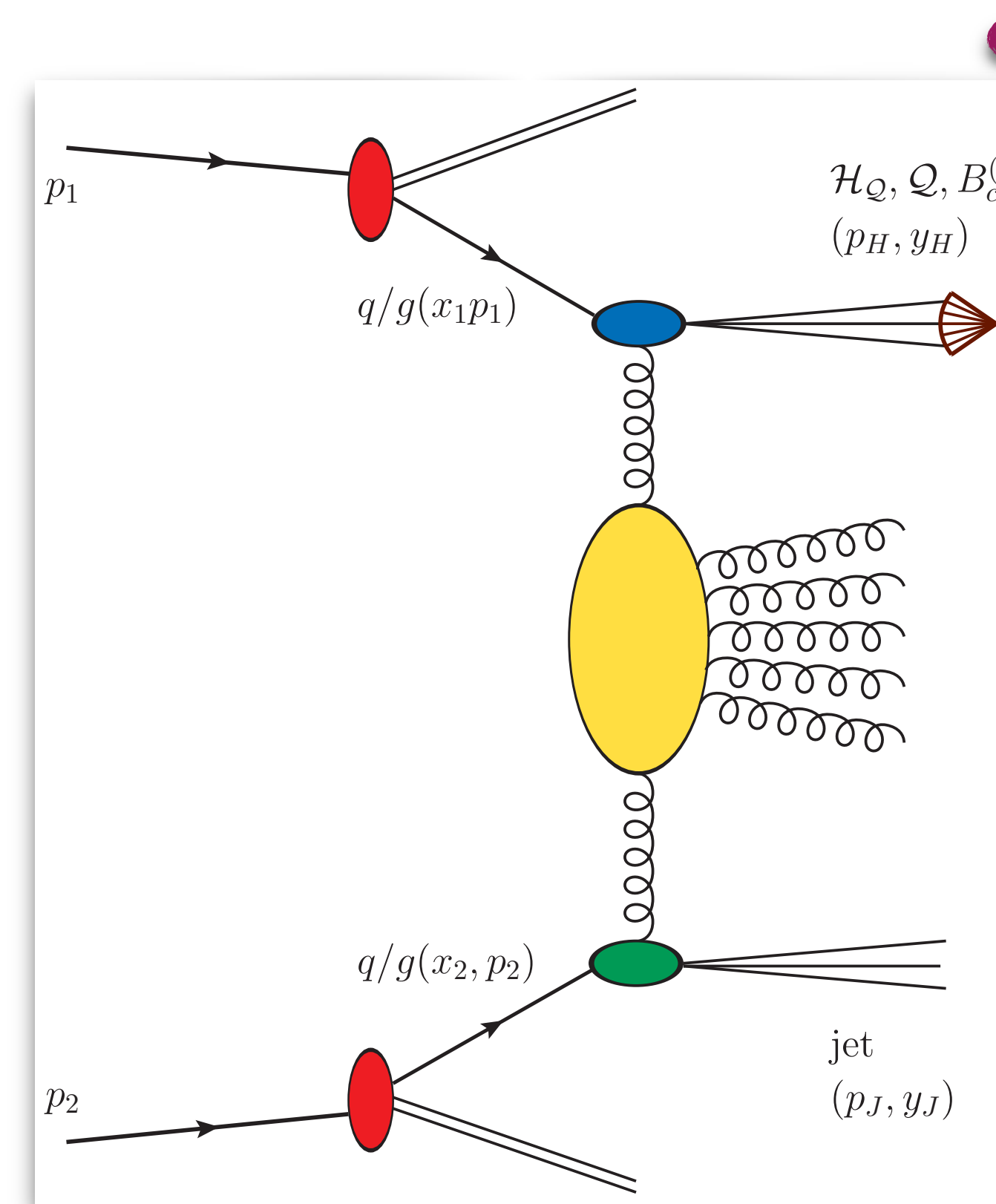

NLO(+)

NLL

NLO(+)

(Higgs + jet, NLL/NLO*) [F. G. C. et al., Eur. Phys. J. C (2021) 8, 780]

(NLO Higgs emission function) [F. G. C., M. Fucilla et al., JHEP 08 (2022) 092]

(Λ_c^\pm baryons, NLL/NLO) [F. G. C. et al., Phys. Rev. D 104 (2021) 11, 114007]

(J/ψ or Υ , NLL/NLO) [F. G. C. et al., Eur. Phys. J. C 82 (2022) 10, 929]

($B_c^\pm(1S_0)$ or $B_c^{*\pm}(3S_1)$, NLL/NLO) [F. G. C., Phys. Lett. B 835 (2022) 137554]

From Mueller-Navelet to Higgs and heavy flavor

Pheno path: hunt for channels leading to a NLL **stabilization pattern** at **natural scales** (!)

HIGGS BOSON

Stabilizers \Leftrightarrow large Higgs **transverse masses**

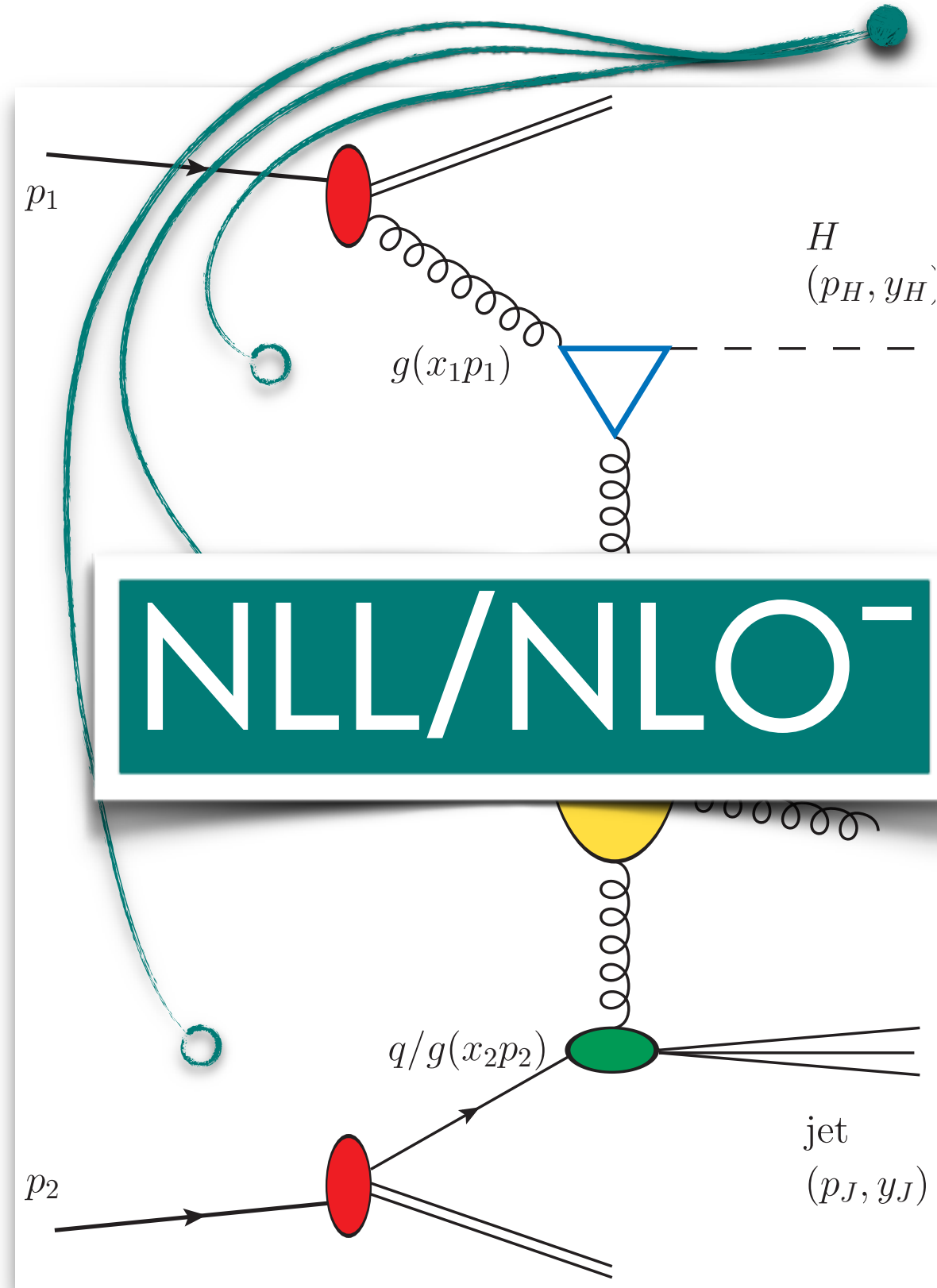

NLL/NLO⁻

$$\mu_{F,R} \sim M_{H,\perp}$$

NLO*

$$= \text{LO} + \text{NLO}_{\text{RGE}}$$

NLL

NLO

(Higgs + jet, NLL/NLO*) \otimes [F. G. C. et al., Eur. Phys. J. C (2021) 8, 780]

(NLO Higgs emission function) \otimes [F. G. C., M. Fucilla et al., JHEP 08 (2022) 092]

HEAVY FLAVOR AT LARGE P_T

Stabilizers \Leftrightarrow gluon fragmentation channels

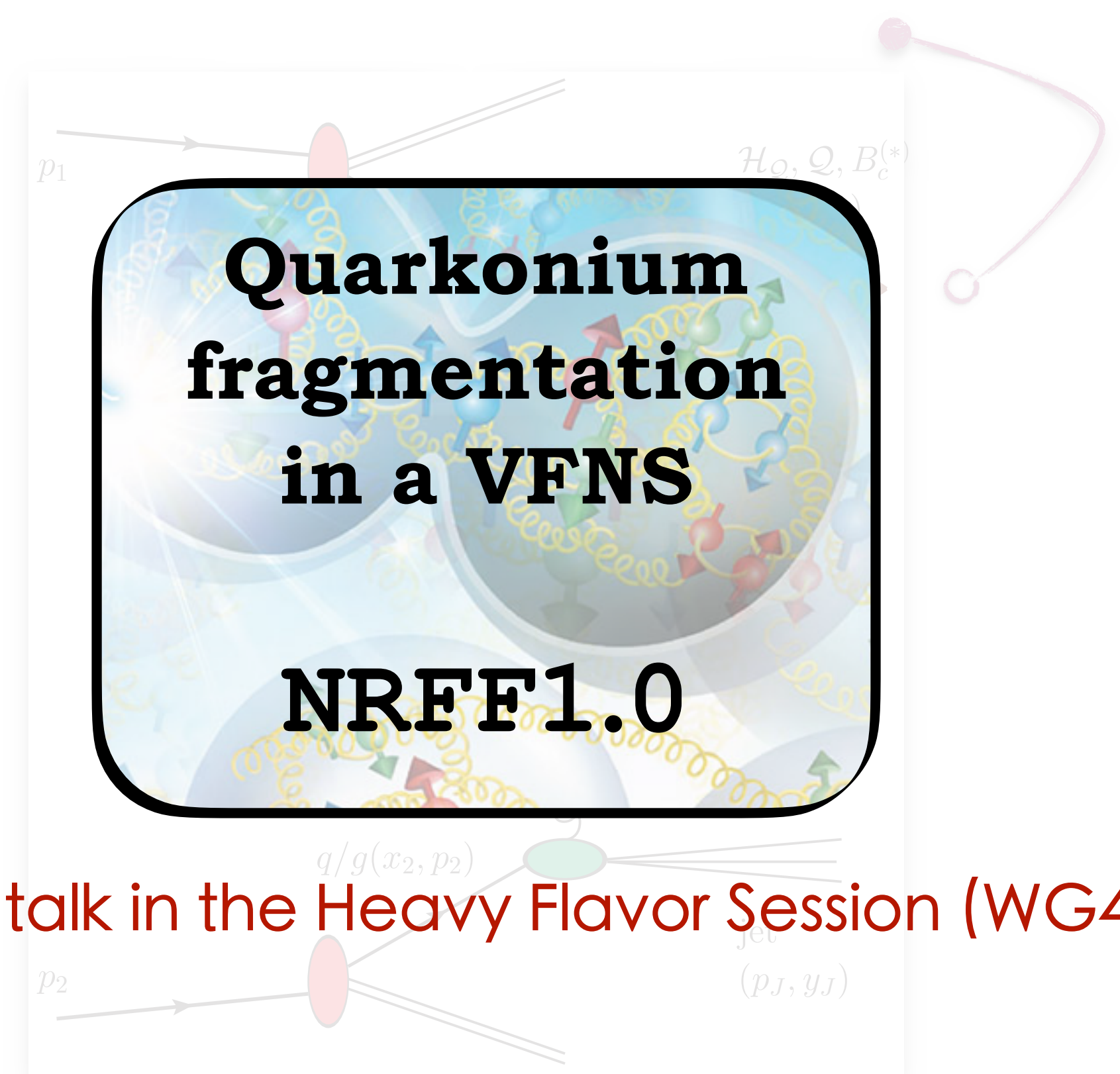

**Quarkonium
fragmentation
in a VFNS**

NREF1.0

NLO(+)

NLL

NLO(+)

[My talk in the Heavy Flavor Session (WG4)]

(Λ_c^\pm baryons, NLL/NLO) \otimes [F. G. C. et al., Phys. Rev. D 104 (2021) 11, 114007]

(J/ψ or Υ , NLL/NLO) \otimes [F. G. C. et al., Eur. Phys. J. C 82 (2022) 10, 929]

($B_c^\pm(1S_0)$ or $B_c^{*\pm}(3S_1)$, NLL/NLO) \otimes [F. G. C., Phys. Lett. B 835 (2022) 137554]

Anatomy of Higgs + jet in hybrid factorization (HyF)

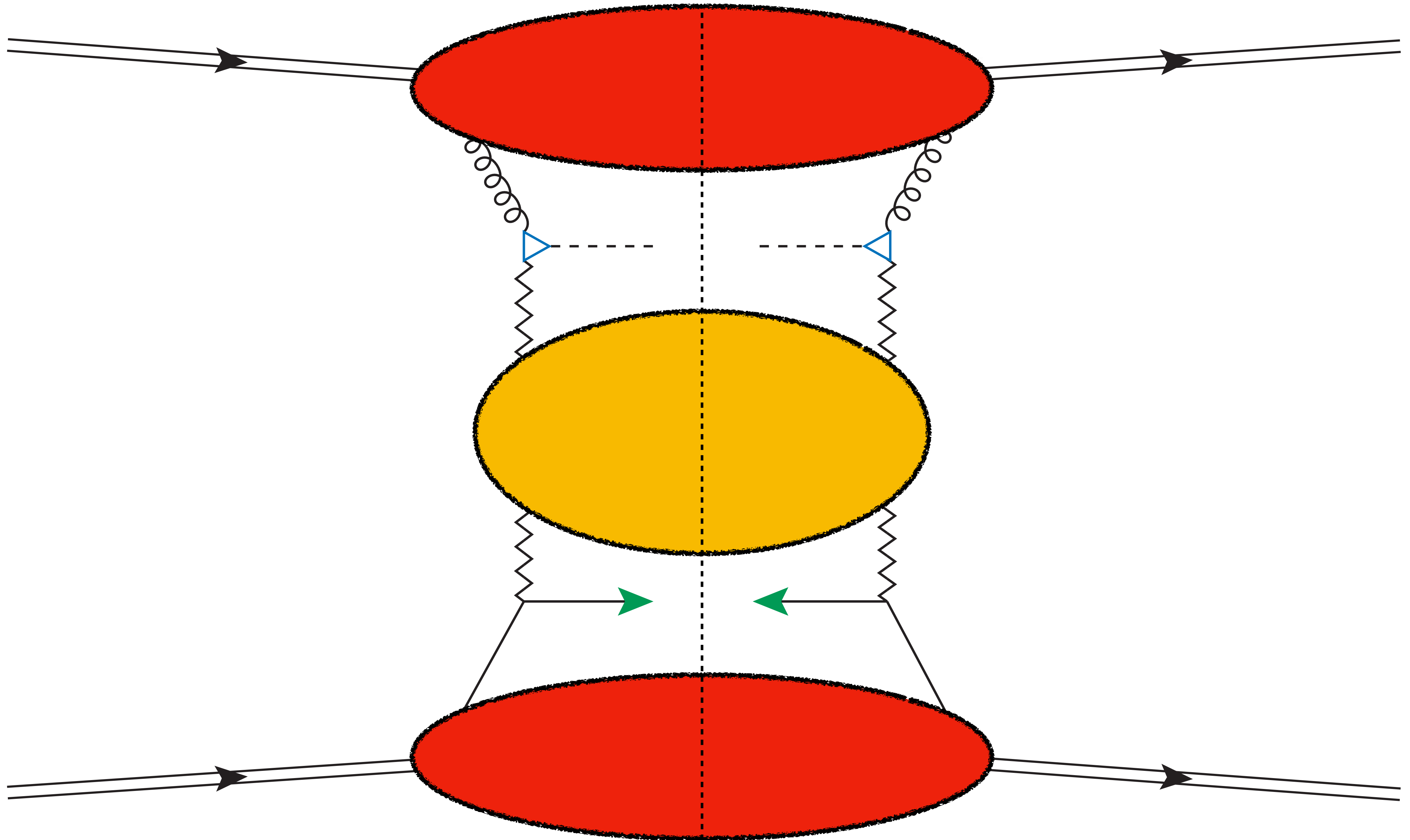

Anatomy of Higgs + jet in hybrid factorization (HyF)

FORWARD REGION

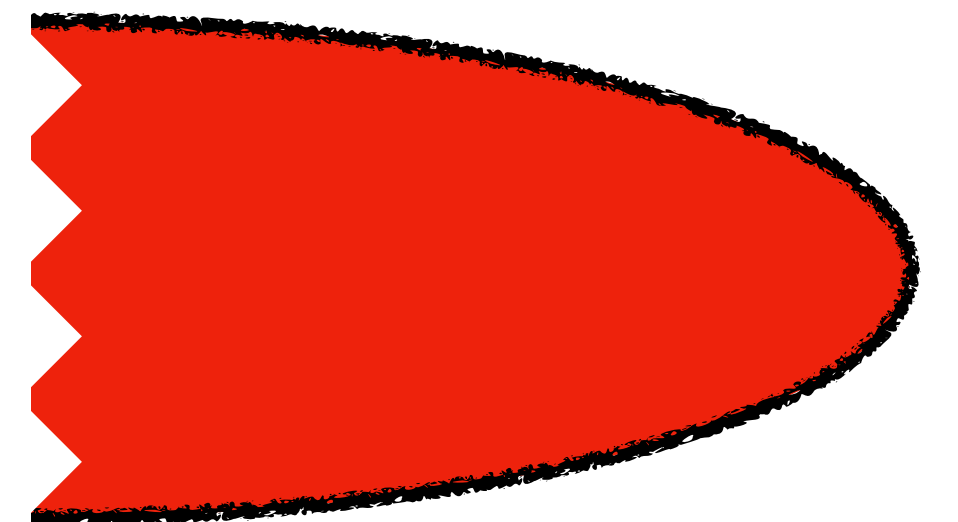
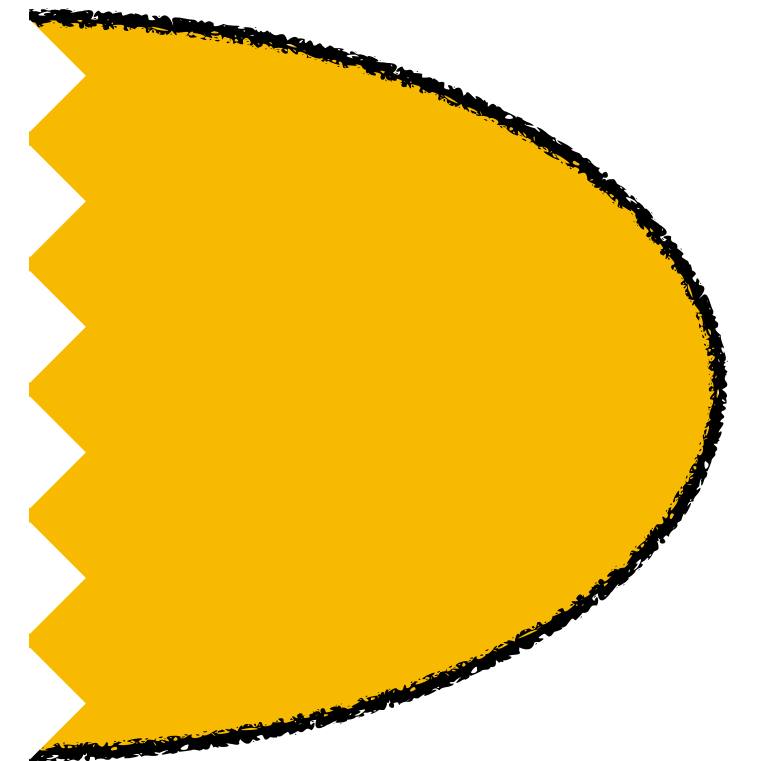
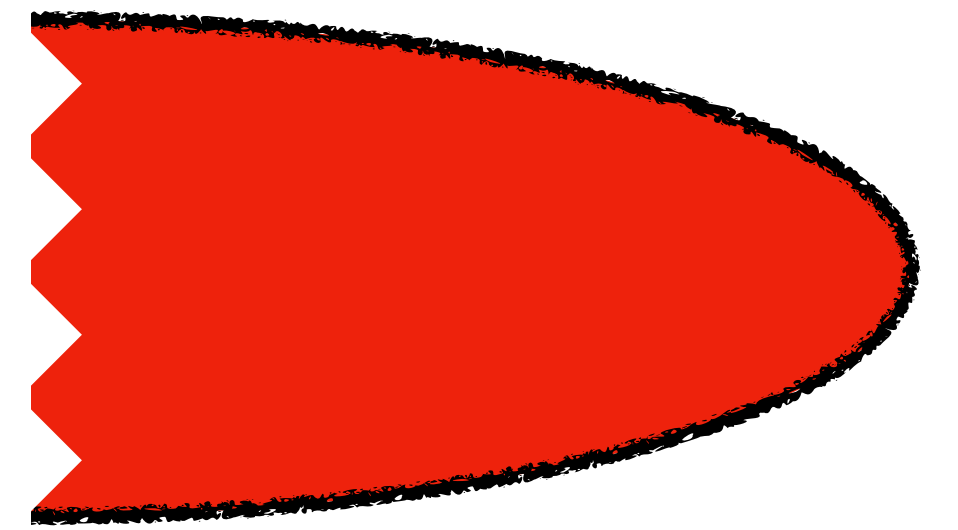
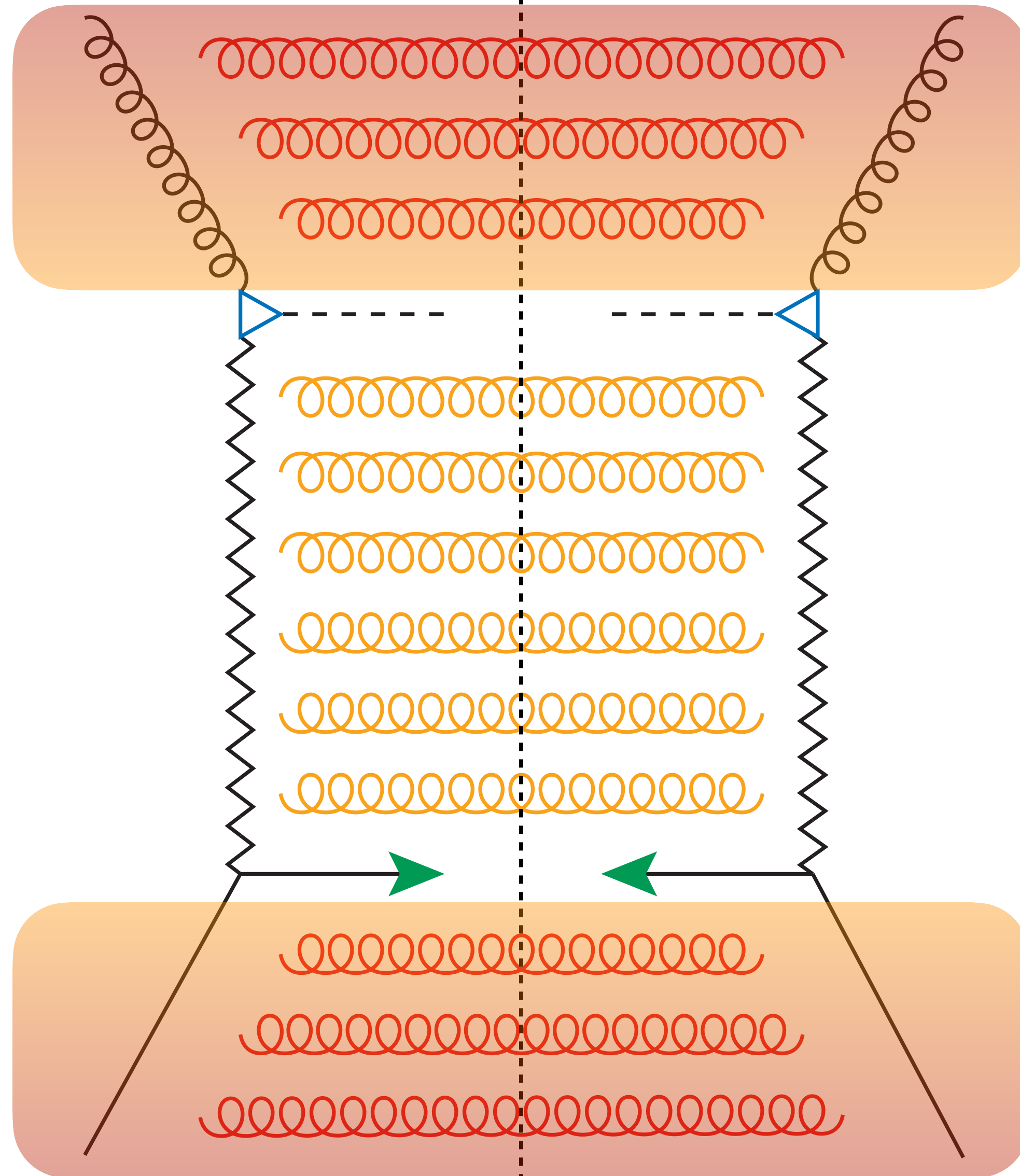
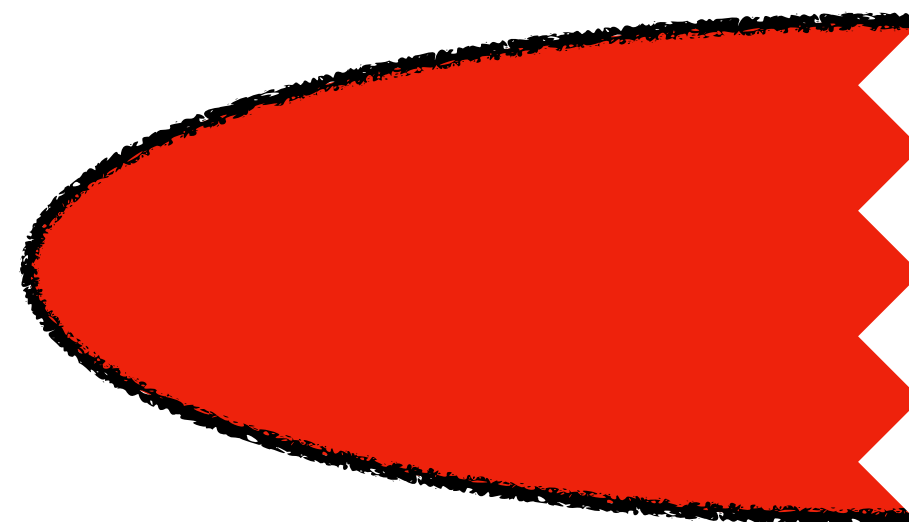
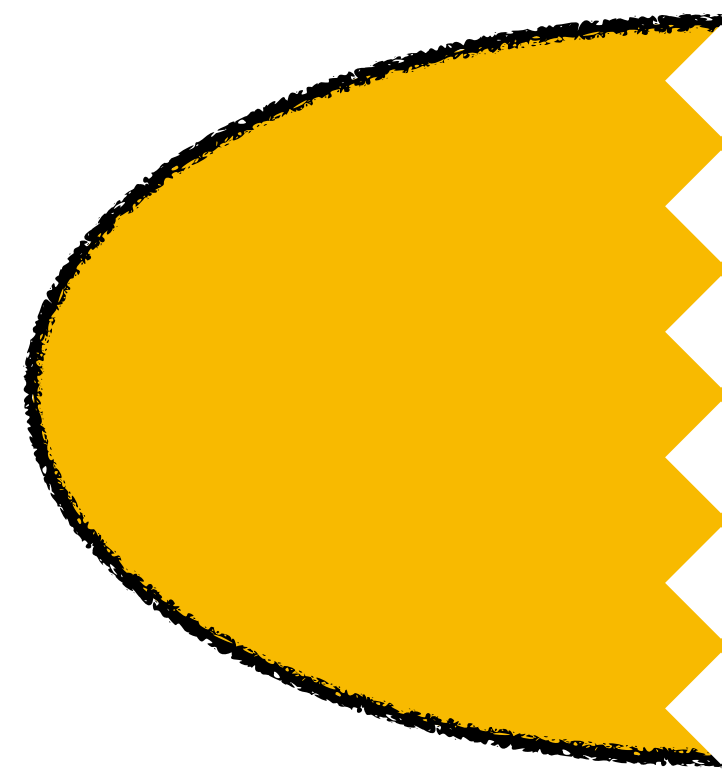
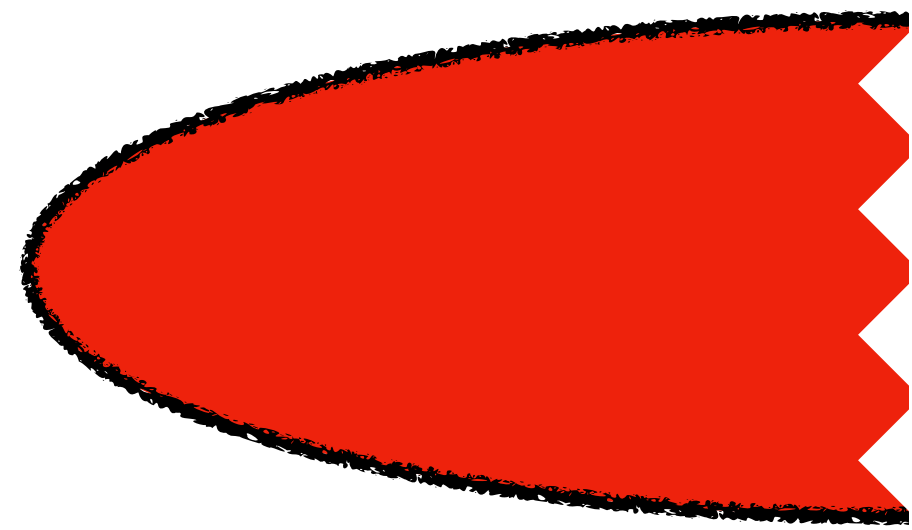

FORWARD REGION

Anatomy of Higgs + jet in hybrid factorization (HyF)

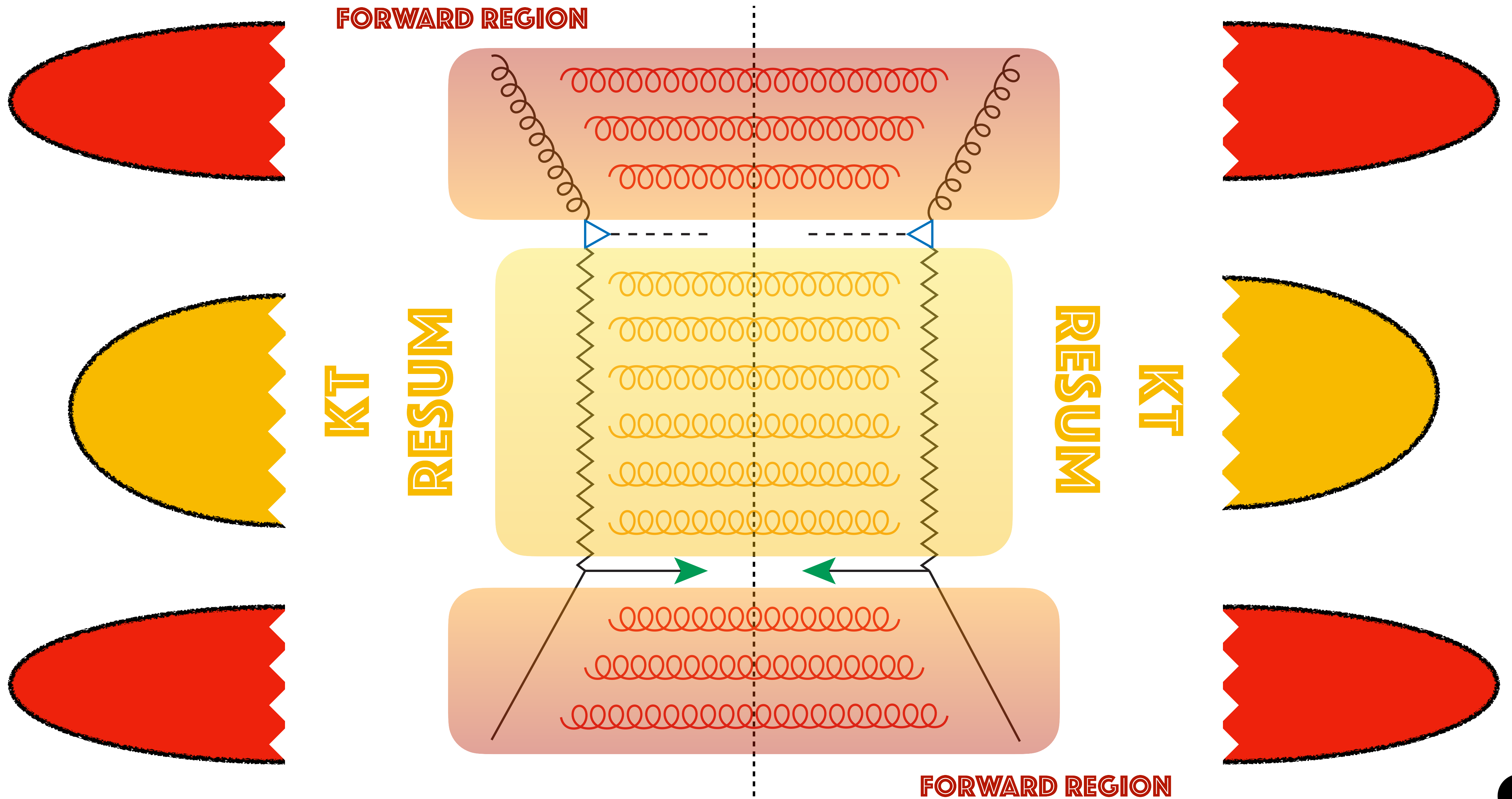

NLL accurate predictions
matched to NLO
via the JETHAD Method

Matching NLL to NLO with JETHAD

; **Precision corrections** *expected* \Leftrightarrow *need* for an accurate NLL-to-NLO **Matching procedure** !

 JETHAD Method \rightarrow NLL/NLO **Additive Matching** (analytic: BFKL kernel + coefficient functions)

$$\underbrace{d\sigma^{\text{NLL/NLO}^-}(\Delta Y, \varphi, s)} = \underbrace{d\sigma^{\text{NLO}}(\Delta Y, \varphi, s)}_{\text{NLO fixed order}} + d\sigma^{\text{NLL}^-}(\Delta Y, \varphi, s) - \Delta d\sigma^{\text{NLL/NLO}^-}(\Delta Y, \varphi, s)$$

NLO POWHEG w/o PS

Matching NLL to NLO with JETHAD

; **Precision corrections** *expected* \Leftrightarrow *need* for an accurate NLL-to-NLO **Matching procedure** !

 JETHAD Method \rightarrow NLL/NLO **Additive Matching** (analytic: BFKL kernel + coefficient functions)

$$\underbrace{d\sigma^{\text{NLL/NLO}^-}(\Delta Y, \varphi, s)} = \underbrace{d\sigma^{\text{NLO}}(\Delta Y, \varphi, s)}_{\substack{\text{NLO fixed order} \\ \text{NLO POWHEG w/o PS}}} + \underbrace{d\sigma^{\text{NLL}^-}(\Delta Y, \varphi, s)}_{\text{NLL}^- \text{ resum (HyF)}} - \Delta d\sigma^{\text{NLL/NLO}^-}(\Delta Y, \varphi, s)$$

Matching NLL to NLO with JETHAD

; **Precision corrections** *expected* \Leftrightarrow *need* for an accurate NLL-to-NLO **Matching procedure** !

 JETHAD Method \rightarrow NLL/NLO **Additive Matching** (analytic: BFKL kernel + coefficient functions)

$$\underbrace{d\sigma^{\text{NLL/NLO}^-}(\Delta Y, \varphi, s)}_{\text{NLO POWHEG w/o PS}} = \underbrace{d\sigma^{\text{NLO}}(\Delta Y, \varphi, s)}_{\text{NLO fixed order}} + \underbrace{d\sigma^{\text{NLL}^-}(\Delta Y, \varphi, s)}_{\text{NLL}^- \text{ resum (HyF)}} - \underbrace{\Delta d\sigma^{\text{NLL/NLO}^-}(\Delta Y, \varphi, s)}_{\text{NLL}^- \text{ expanded at NLO}}$$

NLL⁻ JETHAD w/o NLO⁻ double counting

Matching NLL to NLO with JETHAD

; **Precision corrections** *expected* \Leftrightarrow *need* for an accurate NLL-to-NLO **Matching procedure** !

 JETHAD Method \rightarrow **NLL/NLO Additive Matching** (analytic: BFKL kernel + coefficient functions)

$$\underbrace{d\sigma^{\text{NLL/NLO}^-}(\Delta Y, \varphi, s)}_{\text{NLL/NLO}^- \text{ matched}} = \underbrace{d\sigma^{\text{NLO}}(\Delta Y, \varphi, s)}_{\text{NLO fixed order}} + \underbrace{d\sigma^{\text{NLL}^-}(\Delta Y, \varphi, s)}_{\text{NLL}^- \text{ resum (HyF)}} - \underbrace{\Delta d\sigma^{\text{NLL/NLO}^-}(\Delta Y, \varphi, s)}_{\text{NLL}^- \text{ expanded at NLO}}$$

NLO POWHEG \oplus NLL⁻ JETHAD

 NLO POWHEG w/o PS

 NLL⁻ JETHAD w/o NLO⁻ double counting

HELL + ggHiggs

N³LL_{ix}/LL_{sx}/N³LO

Inclusive Higgs

 [M. Bonvini, S. Marzani (2018)]

Matching NLL to NLO with JETHAD

; **Precision corrections** *expected* \Leftrightarrow *need* for an accurate NLL-to-NLO **Matching procedure** !

 JETHAD Method \rightarrow **NLL/NLO Additive Matching** (analytic: BFKL kernel + coefficient functions)

$$\underbrace{d\sigma^{\text{NLL/NLO}^-}(\Delta Y, \varphi, s)}_{\text{NLL/NLO}^- \text{ matched}} = \underbrace{d\sigma^{\text{NLO}}(\Delta Y, \varphi, s)}_{\text{NLO fixed order}} + \underbrace{d\sigma^{\text{NLL}^-}(\Delta Y, \varphi, s)}_{\text{NLL}^- \text{ resum (HyF)}} - \underbrace{\Delta d\sigma^{\text{NLL/NLO}^-}(\Delta Y, \varphi, s)}_{\text{NLL}^- \text{ expanded at NLO}}$$

NLO POWHEG \oplus NLL⁻ JETHAD

 NLO POWHEG w/o PS

 NLL⁻ JETHAD w/o NLO⁻ double counting

HELL + ggHiggs
 N³LL_{ix}/LL_{sx}/N³LO
 Inclusive Higgs
 [M. Bonvini, S. Marzani (2018)]

HEJ framework
 NLL_{sx}⁻/NLO
 Higgs + jet(s)
 [J. R. Andersen et al. (2022)]

Matching NLL to NLO with JETHAD

; **Precision corrections** *expected* \Leftrightarrow *need* for an accurate NLL-to-NLO **Matching procedure** !

 JETHAD Method \rightarrow **NLL/NLO Additive Matching** (analytic: BFKL kernel + coefficient functions)

$$\underbrace{d\sigma^{\text{NLL/NLO}^-}(\Delta Y, \varphi, s)}_{\text{NLL/NLO}^- \text{ matched}} = \underbrace{d\sigma^{\text{NLO}}(\Delta Y, \varphi, s)}_{\text{NLO fixed order}} + \underbrace{d\sigma^{\text{NLL}^-}(\Delta Y, \varphi, s)}_{\text{NLL}^- \text{ resum (HyF)}} - \underbrace{\Delta d\sigma^{\text{NLL/NLO}^-}(\Delta Y, \varphi, s)}_{\text{NLL}^- \text{ expanded at NLO}}$$

NLO POWHEG \oplus NLL⁻ JETHAD

 NLO POWHEG w/o PS

 NLL⁻ JETHAD w/o NLO⁻ double counting

HELL + ggHiggs

N³LL_{ix}/LL_{sx}/N³LO

Inclusive Higgs

 [M. Bonvini, S. Marzani (2018)]

HEJ framework

NLL_{sx}⁻/NLO

Higgs + jet(s)

 [J. R. Andersen et al. (2022)]

RadISH + MCFM-8.3

NNLL_{TM}/NLO

Higgs + jet

 [P.F. Monni et al. (2020)]

The Higgs + jet spectrum from POWHEG + JETHAD

$$p(P_a) + p(P_b) \rightarrow H(p_H, y_H) + \mathcal{X} + \text{jet}(p_J, y_J)$$

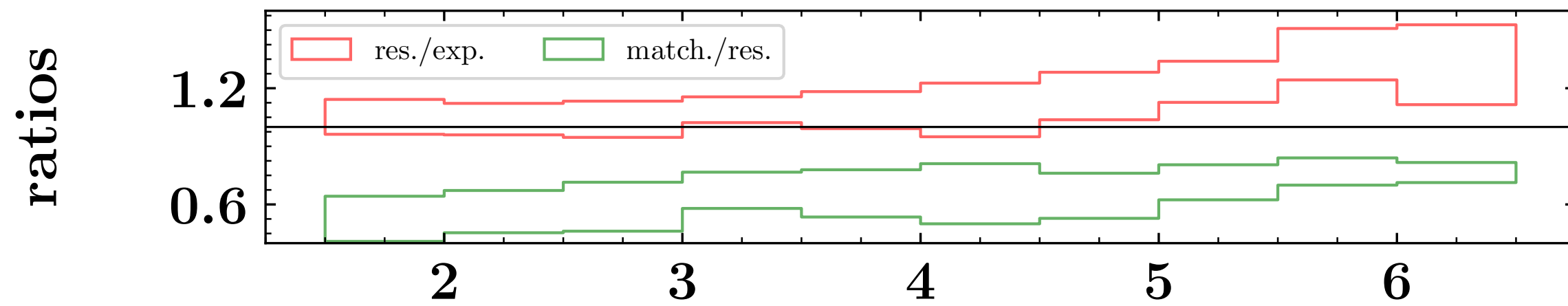
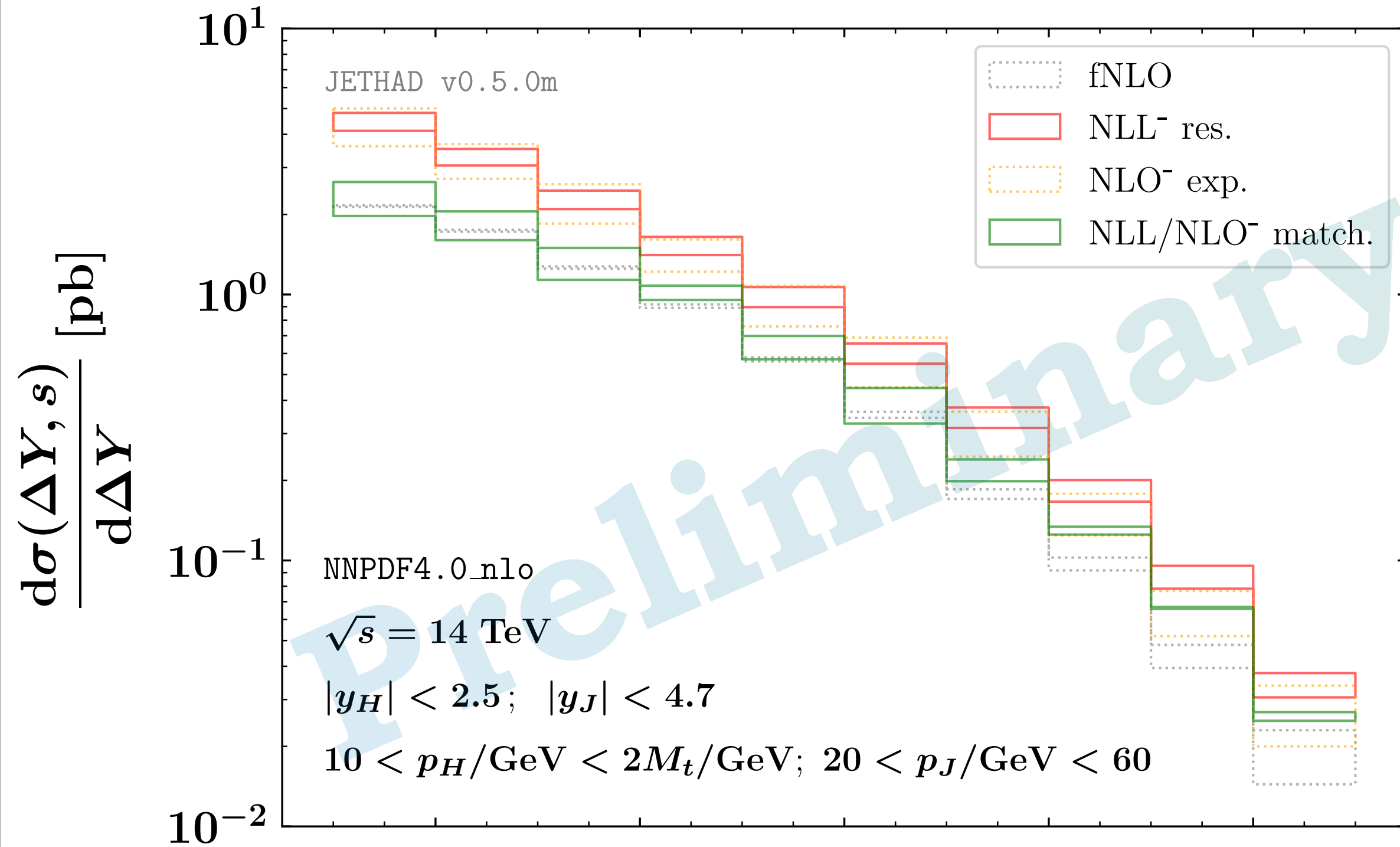

$$\Delta Y = y_H - y_J$$

$$p(P_a) + p(P_b) \rightarrow H(p_H, y_H) + \mathcal{X} + \text{jet}(p_J, y_J)$$

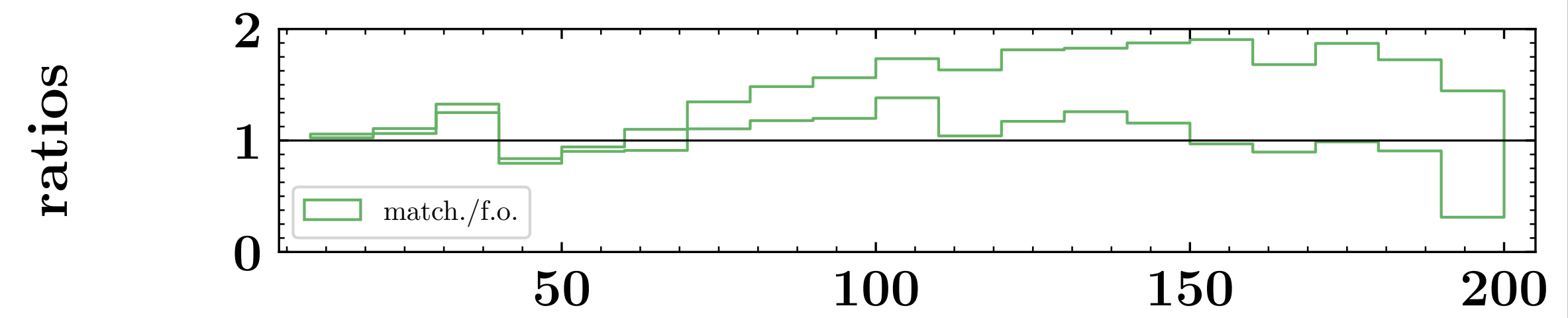
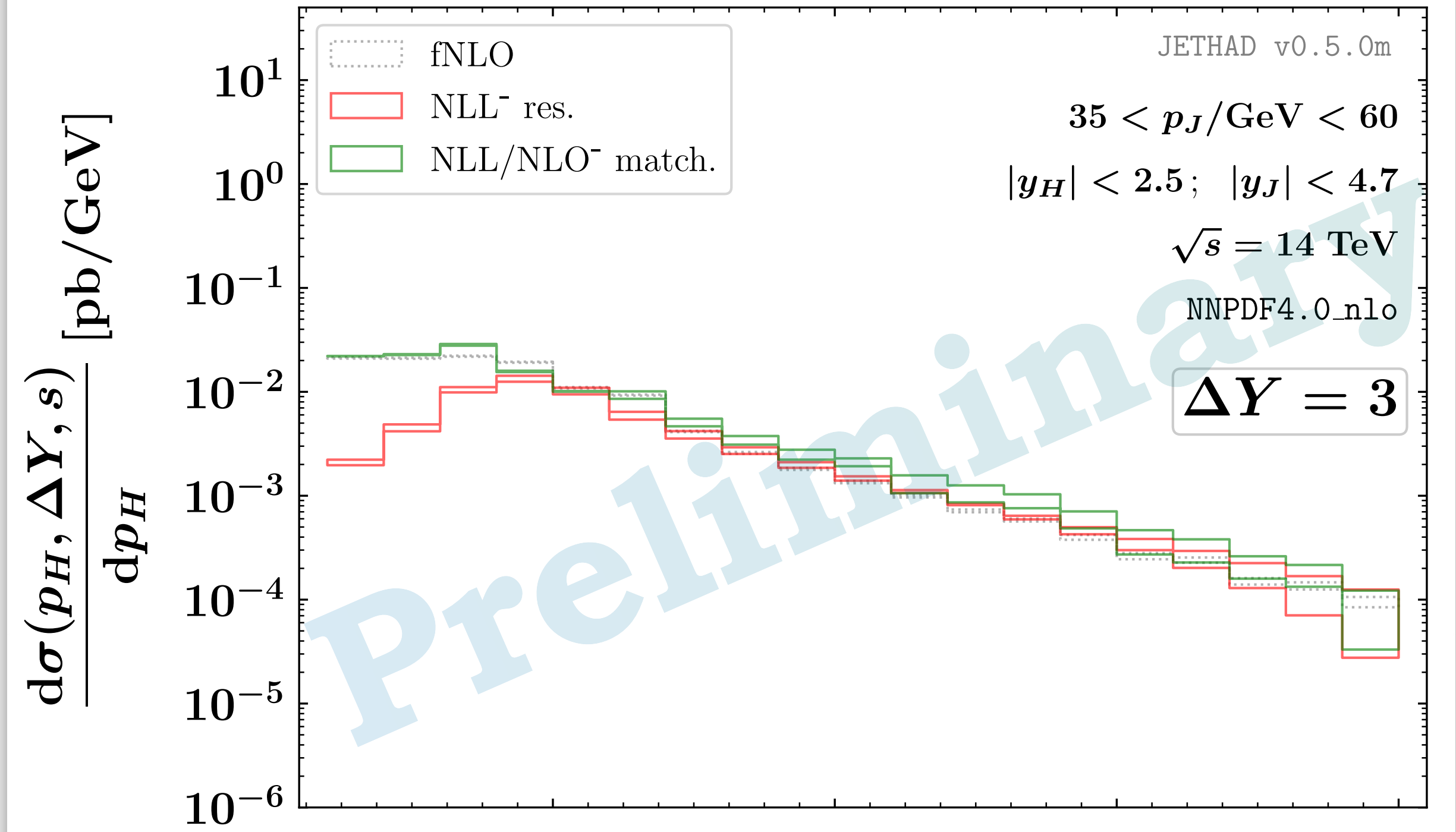

$$p_H \text{ [GeV]}$$

ΔY spectrum

@14 TeV LHC

p_H spectrum

NLL matched to NLO fixed-order POWHEG + JETHAD (in progress)

Small- x and large- x enhancement from PDFs

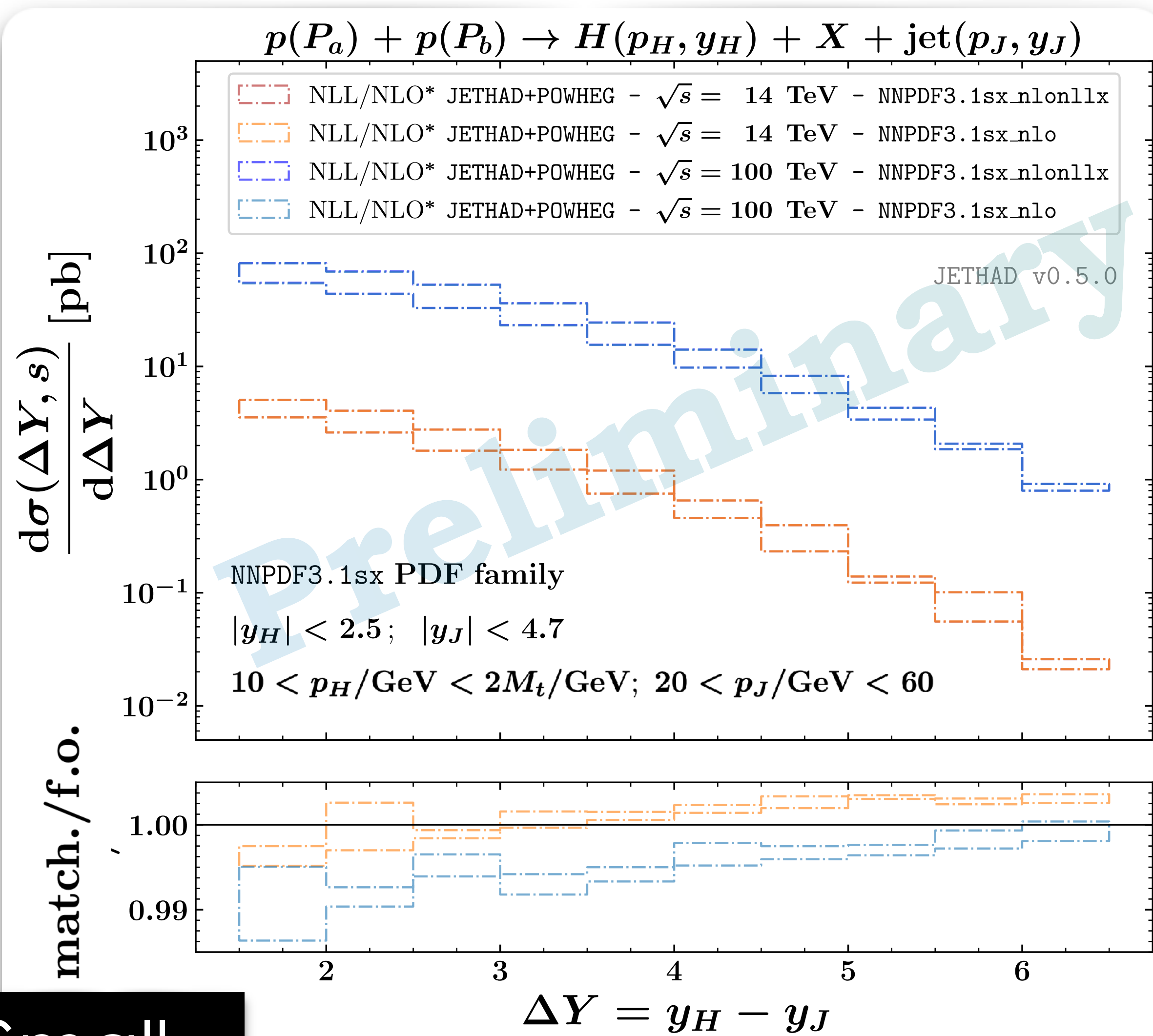

Small- x

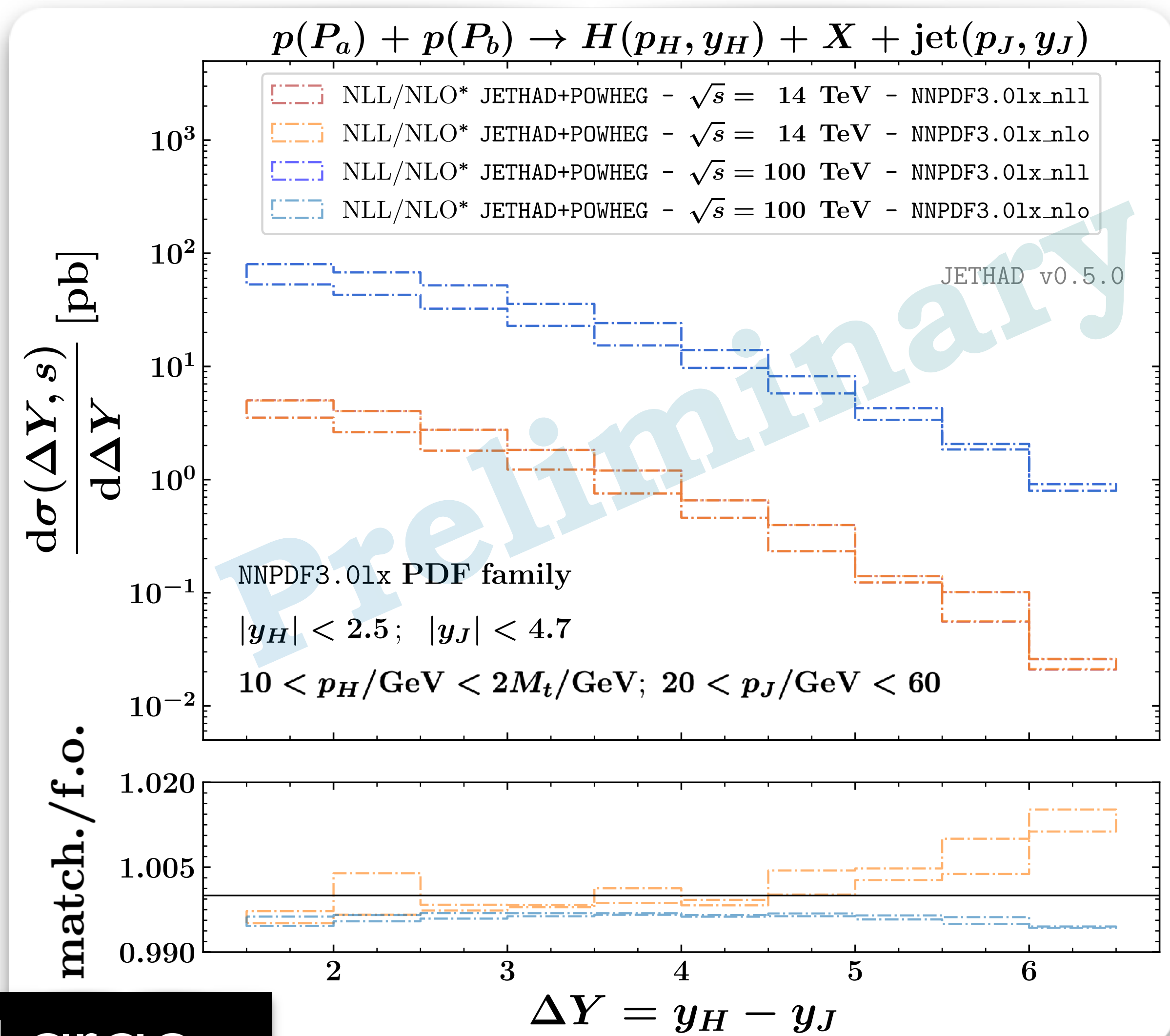

Large- x

Small- x and large- x enhancement from PDFs

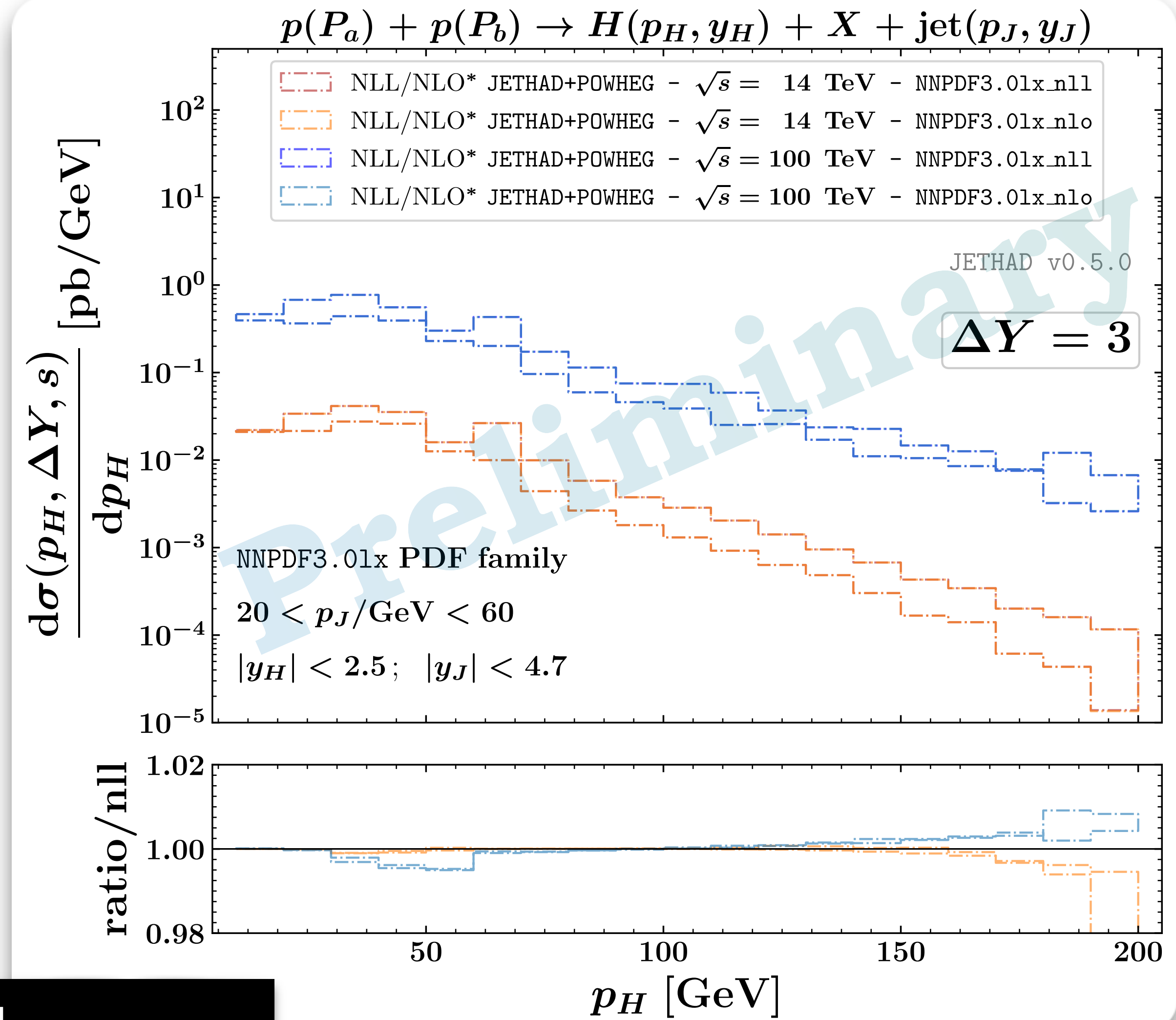
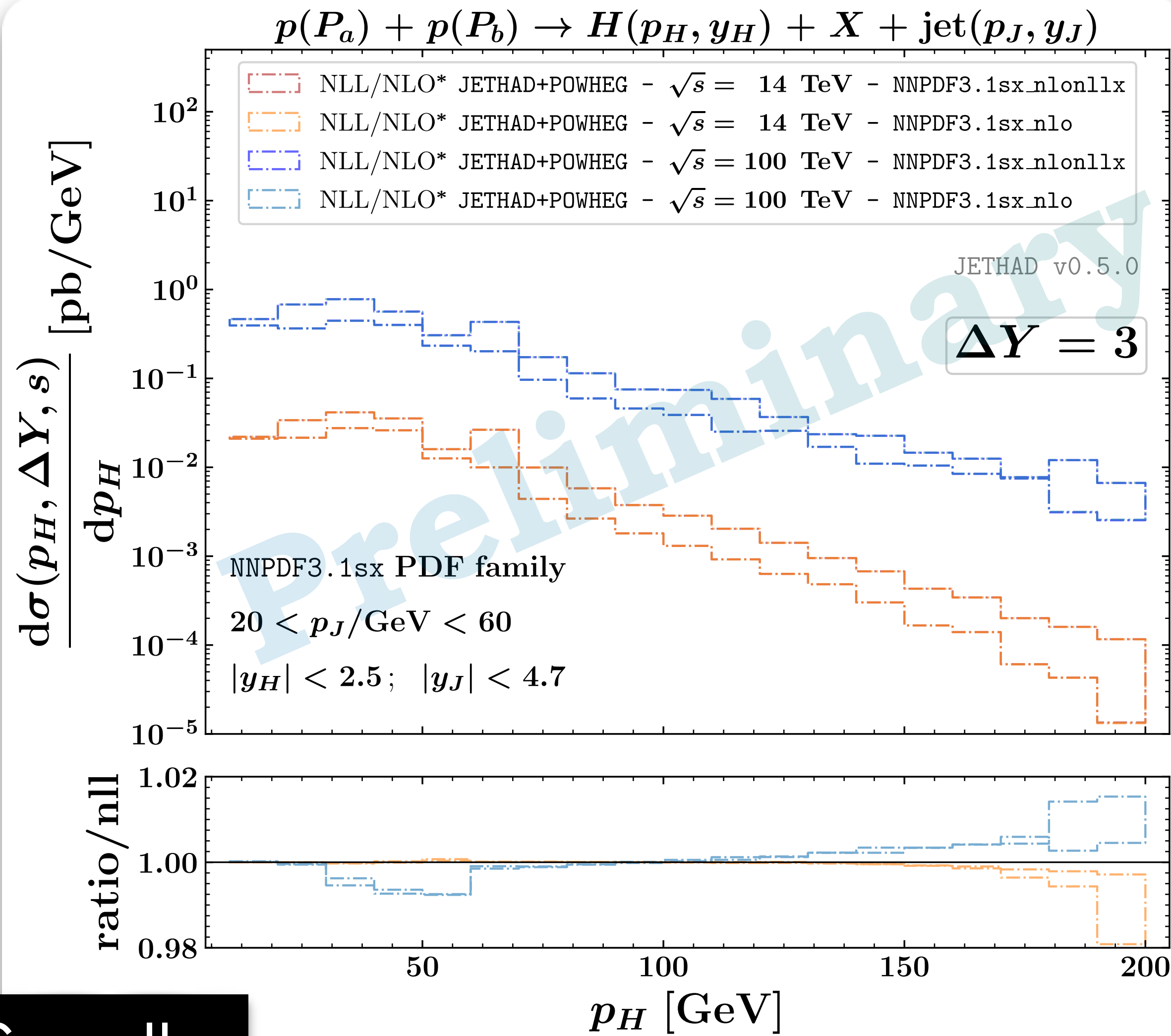

Small- x

Large- x

Finite top- and bottom-mass corrections

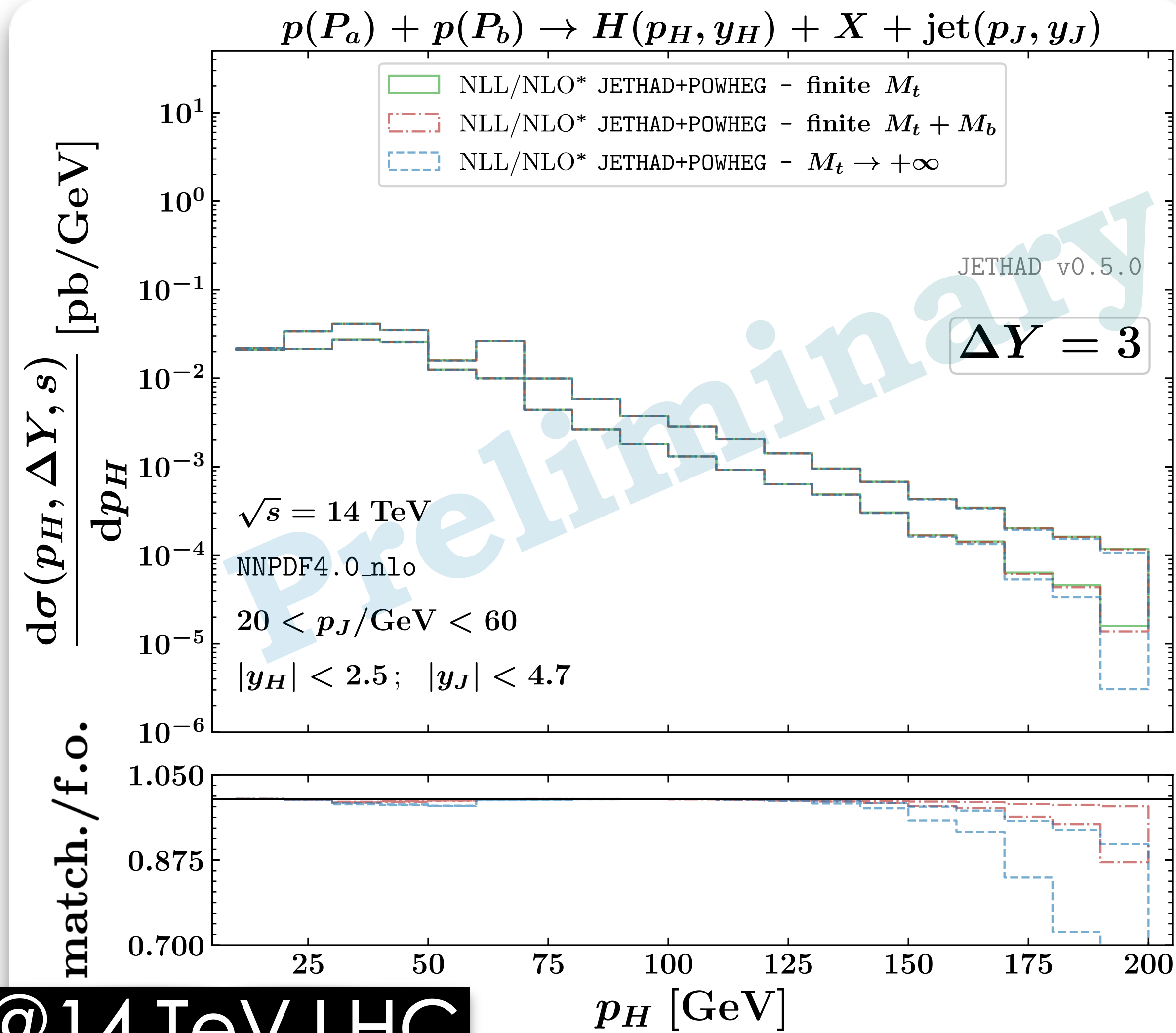

@14 TeV LHC

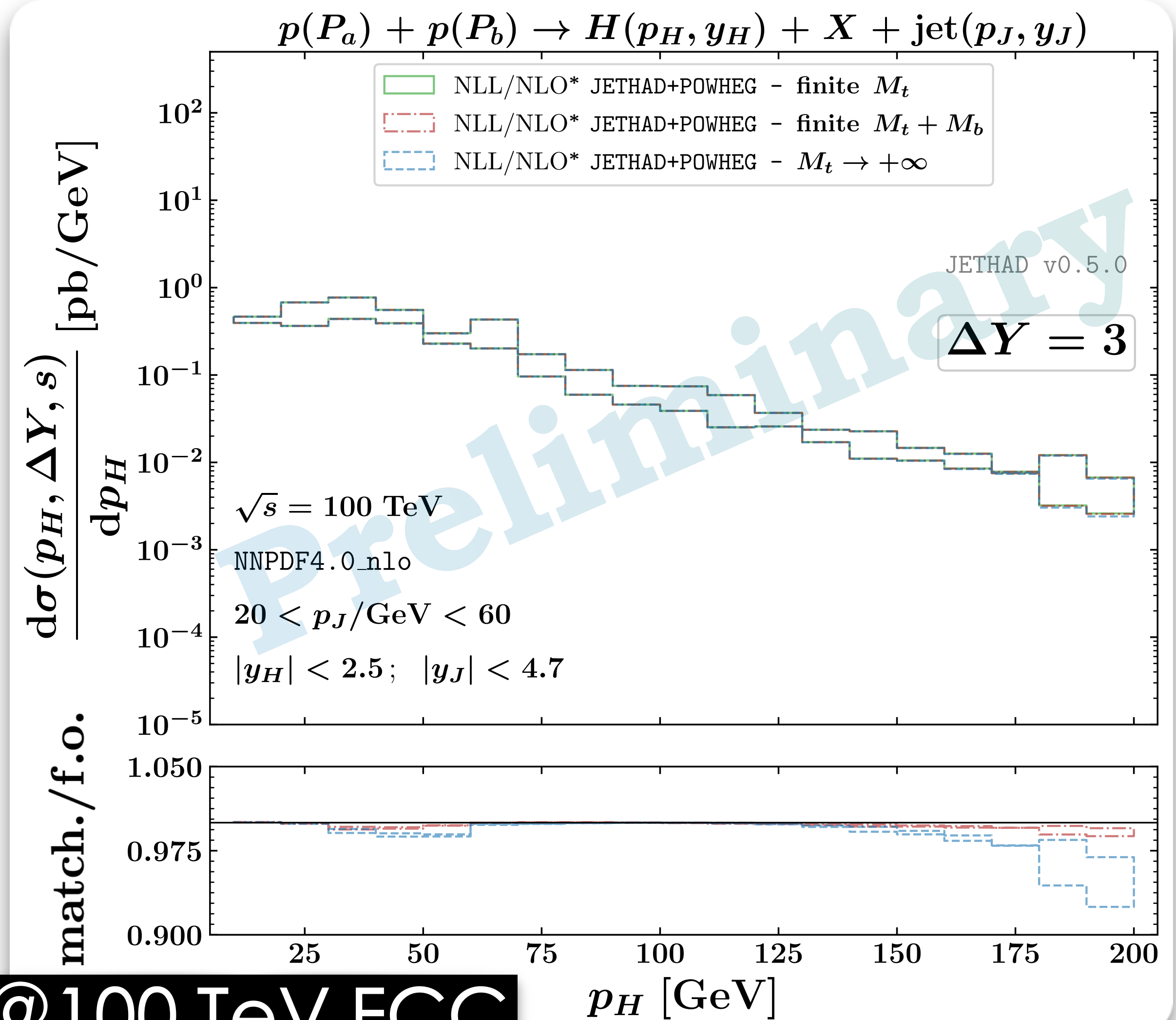

@100 TeV FCC

Towards Z + jet
at NLL/NLO⁺
via the JETHAD Method

Forward Drell-Yan production

- LHC, **forward region** $\rightarrow (l^+ l^-)$ produced in the fragmentation region of h_2
 - ◇ Asymmetric configuration: $x_1 \gg x_2$, down to $x_2 \simeq 10^{-6}$
- \implies **possible small- x resummation effects expected!**

Forward Drell-Yan production

- LHC, **forward region** $\rightarrow (l^+ l^-)$ produced in the fragmentation region of h_2
 - ◇ Asymmetric configuration: $x_1 \gg x_2$, down to $x_2 \simeq 10^{-6}$
- \Rightarrow **possible small- x resummation effects expected!**

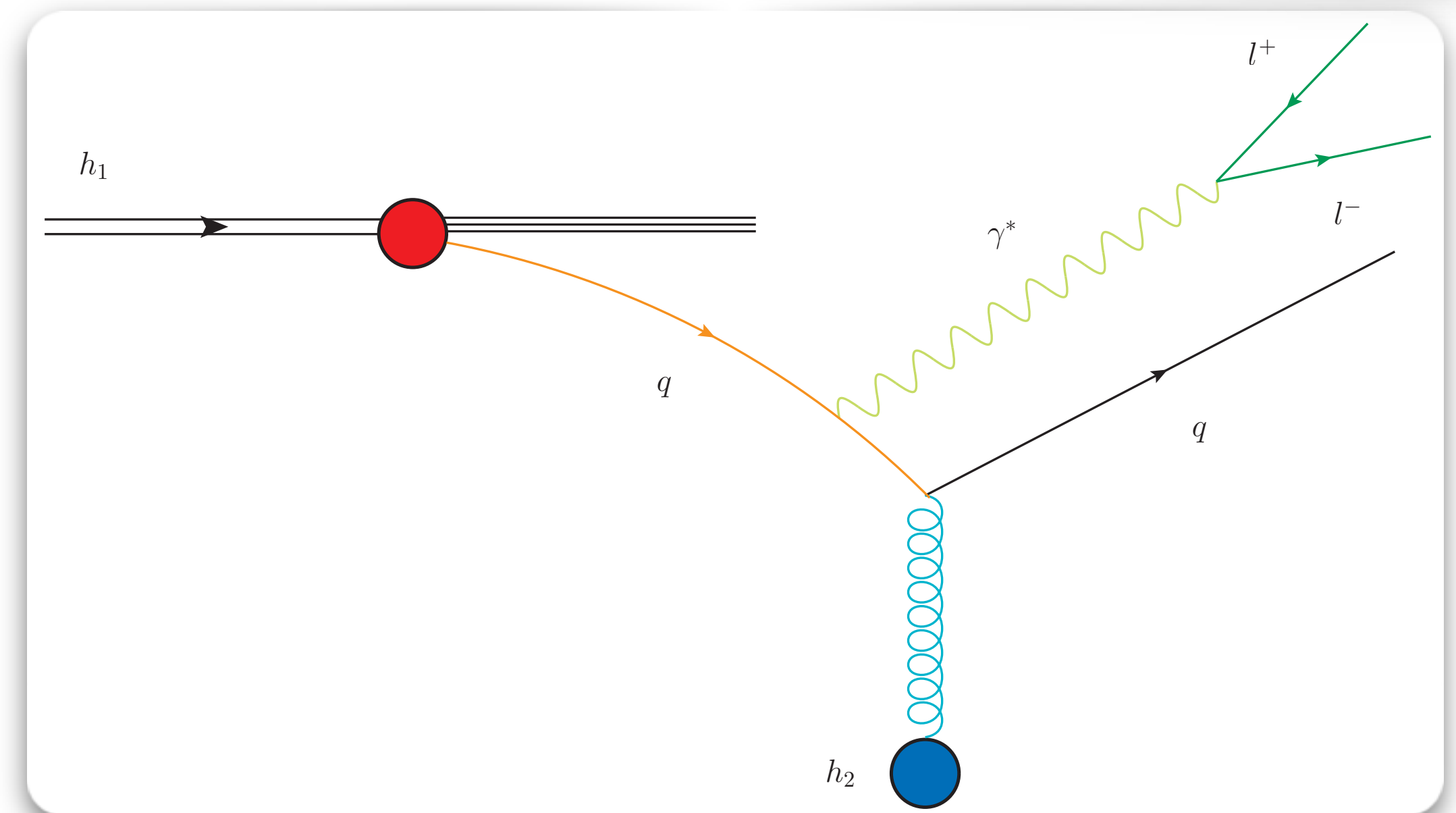
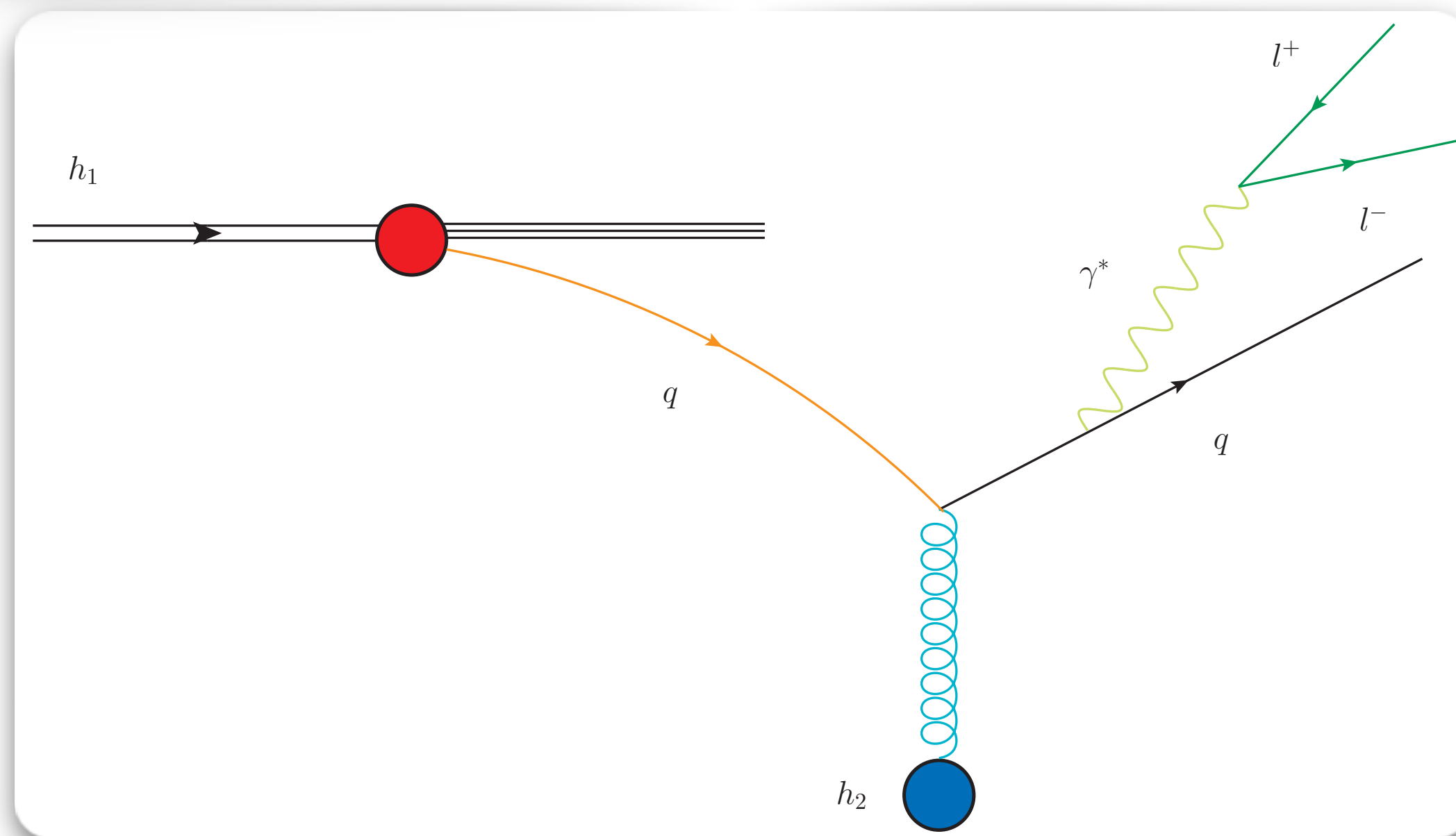

(LO DY emission functions + Mellin) [\[G. Golec-Biernat, E. Lewandowska, A. M. Stasto, Phys. Rev. D 82 \(2010\) 094010\]](#)

(LO DY emission functions + Mellin) [\[L. Motyka, M. Sadzikowski, T. Stebel, JHEP 05 \(2015\) 087\]](#)

(Twist decomposition + pheno) [\[D. Brzemiński, L. Motyka, M. Sadzikowski, T. Stebel, JHEP 01 \(2017\) 005\]](#)

Forward Drell-Yan production @LHC (2018)

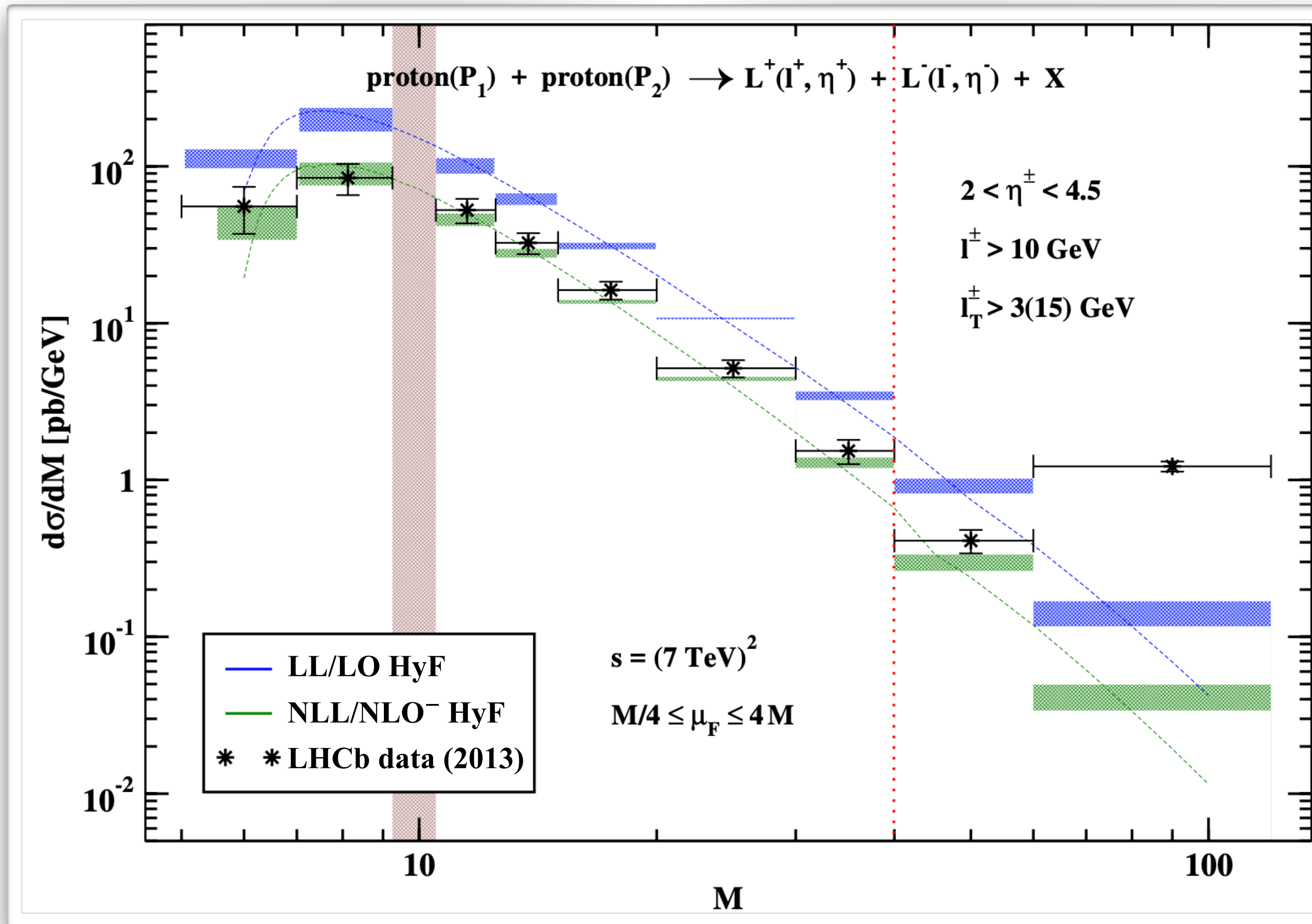

NLL/NLO⁻ studies @7TeV LHCb

Forward Drell-Yan production @LHC (2018)

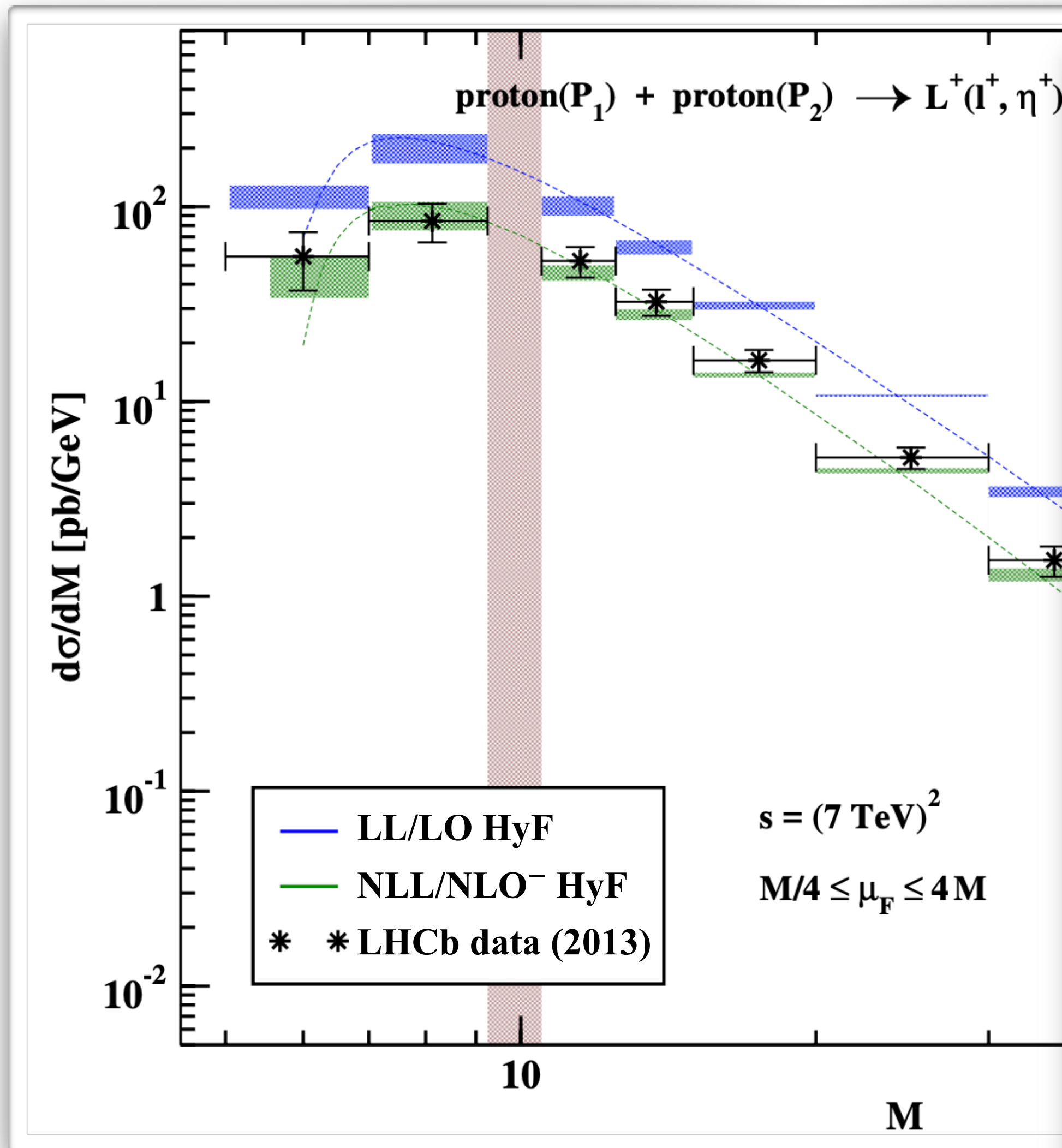

NLL/NLO⁻ studies @7TeV LHCb

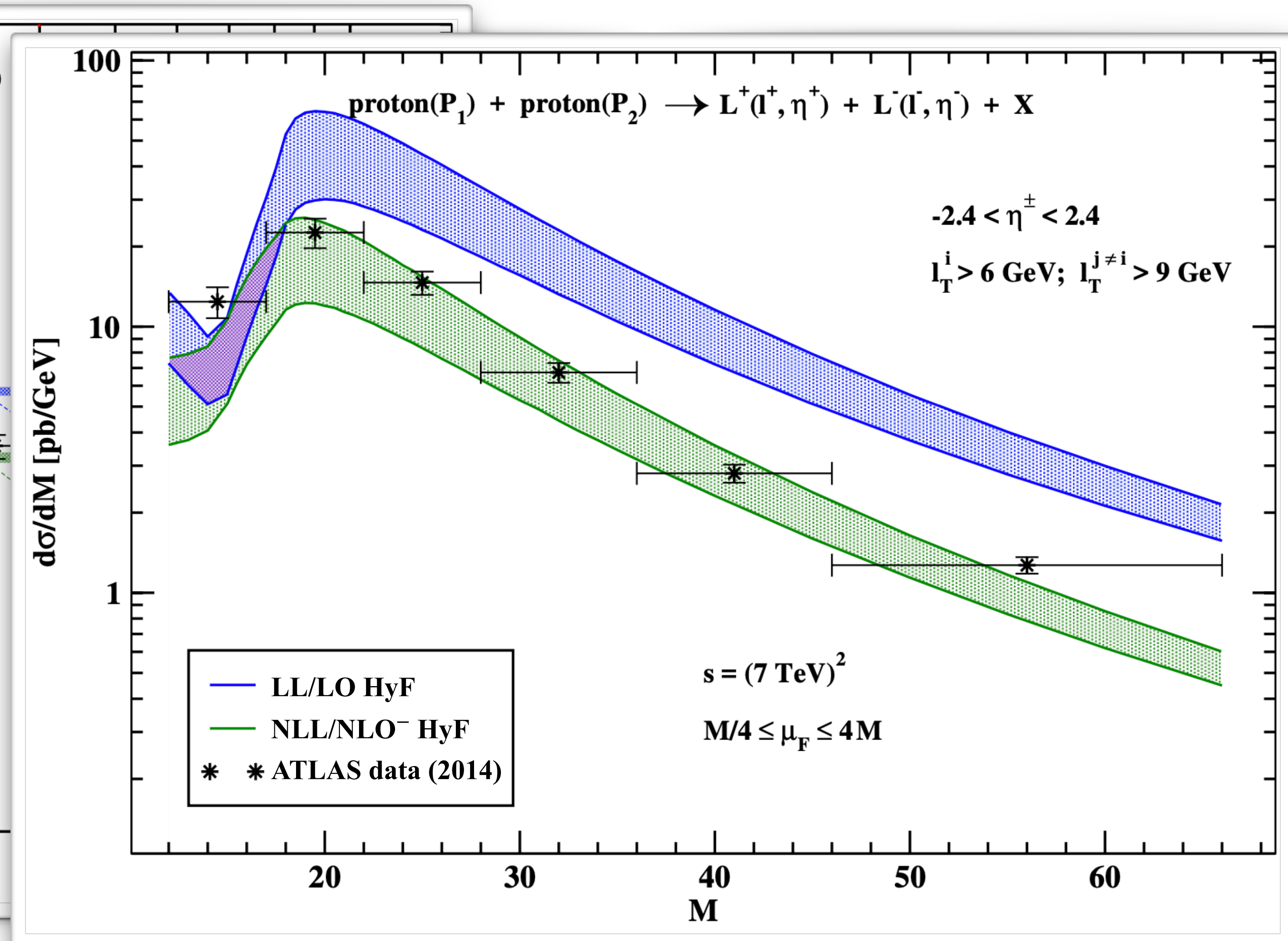

NLL/NLO⁻ studies @7TeV ATLAS

From Mueller-Navelet to Higgs and heavy flavor

HIGGS BOSON + JET

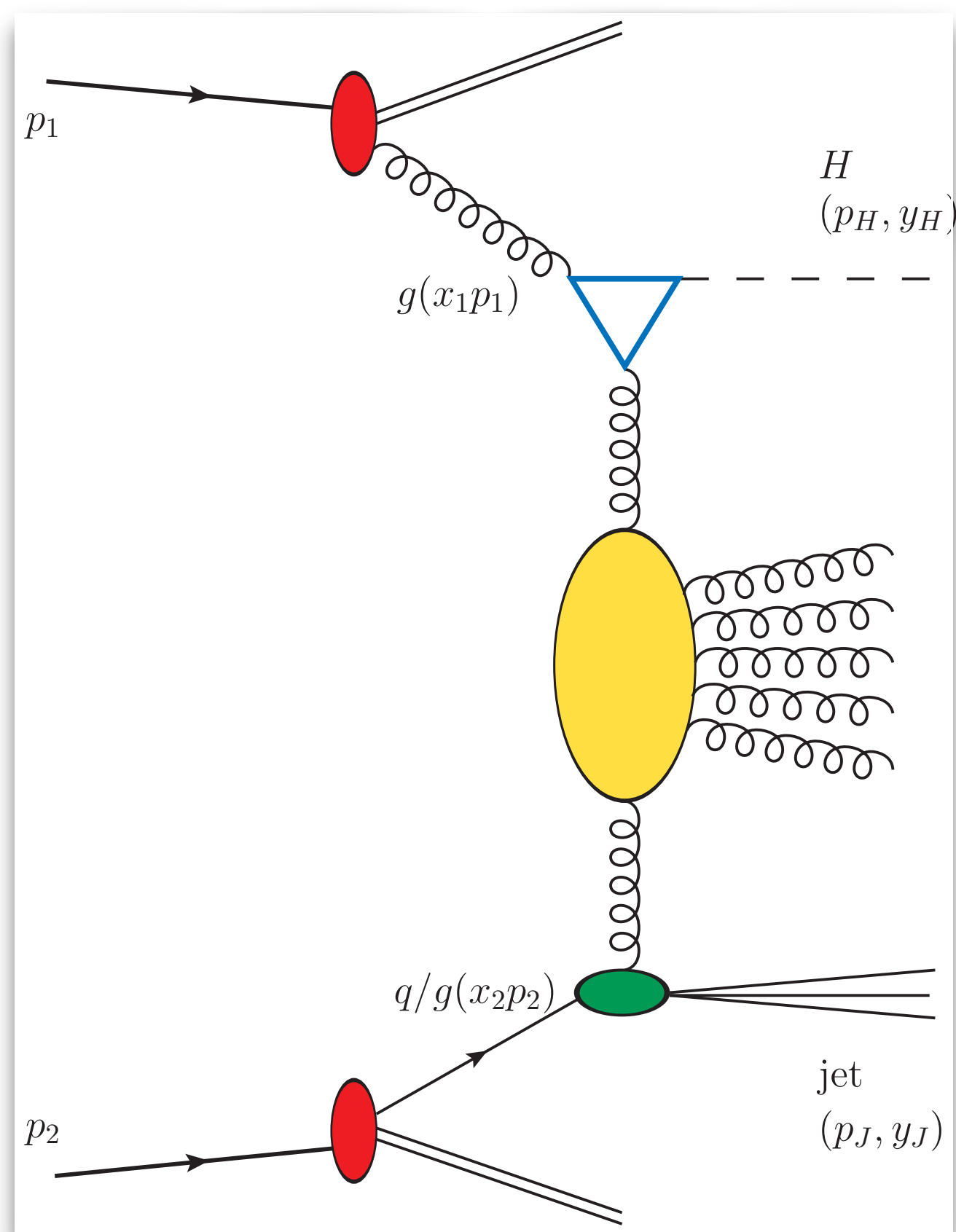

(Higgs + jet, NLL/NLO*) [\[F. G. C. et al., Eur. Phys. J. C \(2021\) 8, 780\]](#)

(NLO emission function) [\[F. G. C., M. Fucilla et al., JHEP 08 \(2022\) 092\]](#)

From Mueller-Navelet to Higgs and heavy flavor

HIGGS BOSON + JET

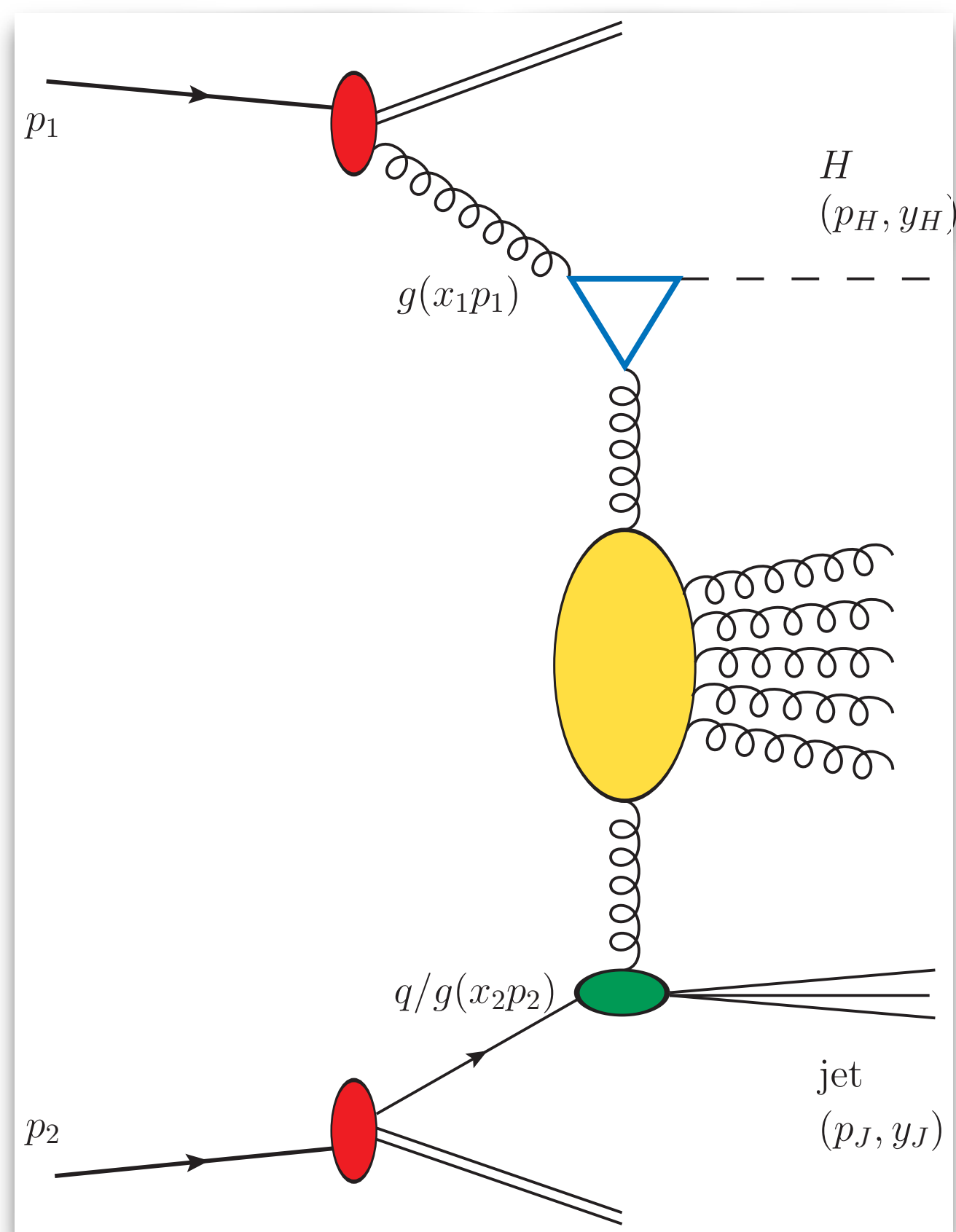

(Higgs + jet, NLL/NLO*) [\[F. G. C. et al., Eur. Phys. J. C \(2021\) 8, 780\]](#)
 (NLO emission function) [\[F. G. C., M. Fucilla et al., JHEP 08 \(2022\) 092\]](#)

Z BOSON + JET

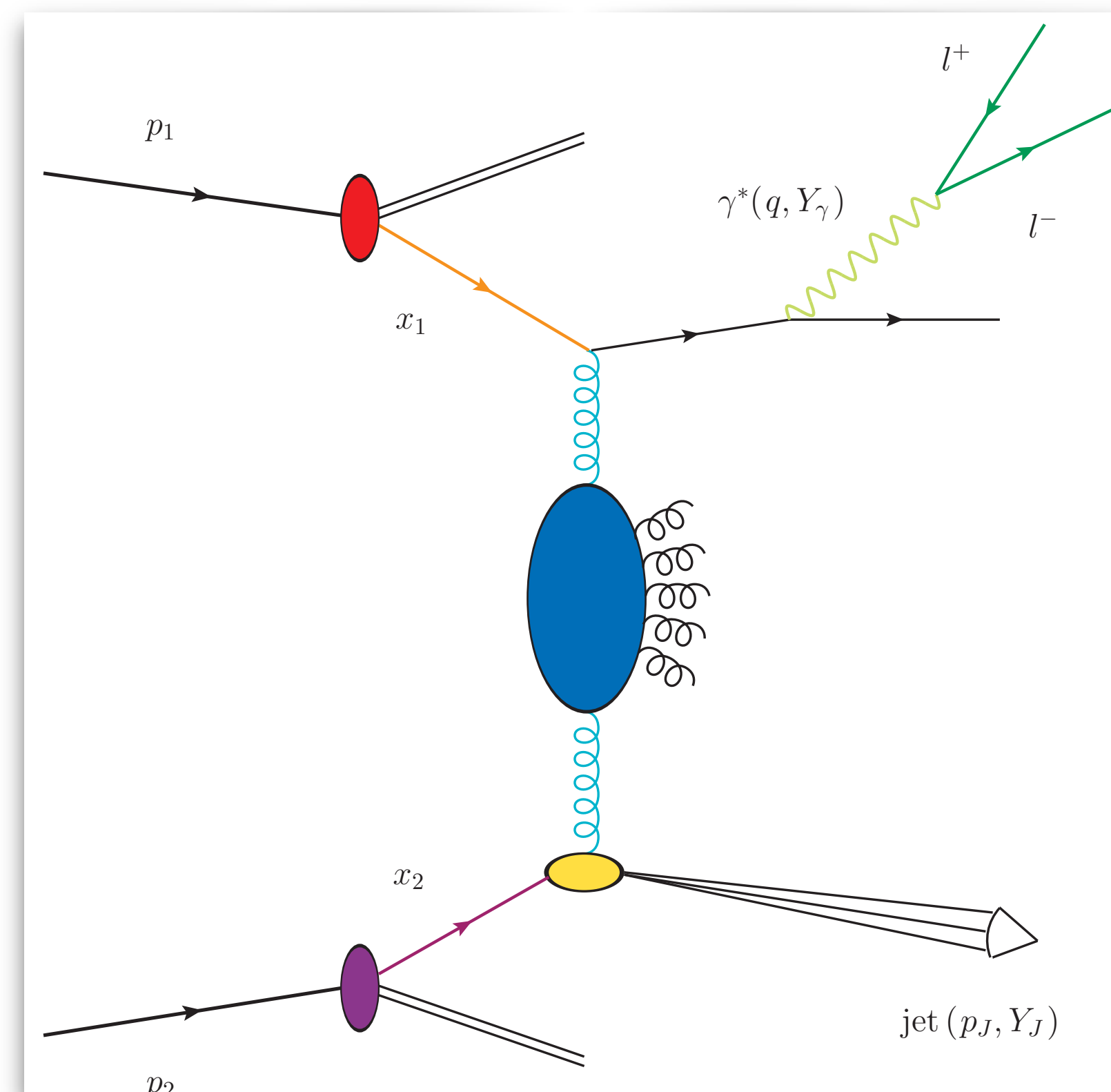

(DY + jet, LL/LO⁺) [\[L. Motyka et al., JHEP 12 \(2018\) 091\]](#)
 (DY and Z + jet, NLL/NLO⁻) [\[F. G. C. et al. \(in progress\)\]](#)

From Mueller-Navelet to Higgs and heavy flavor

HIGGS BOSON + JET

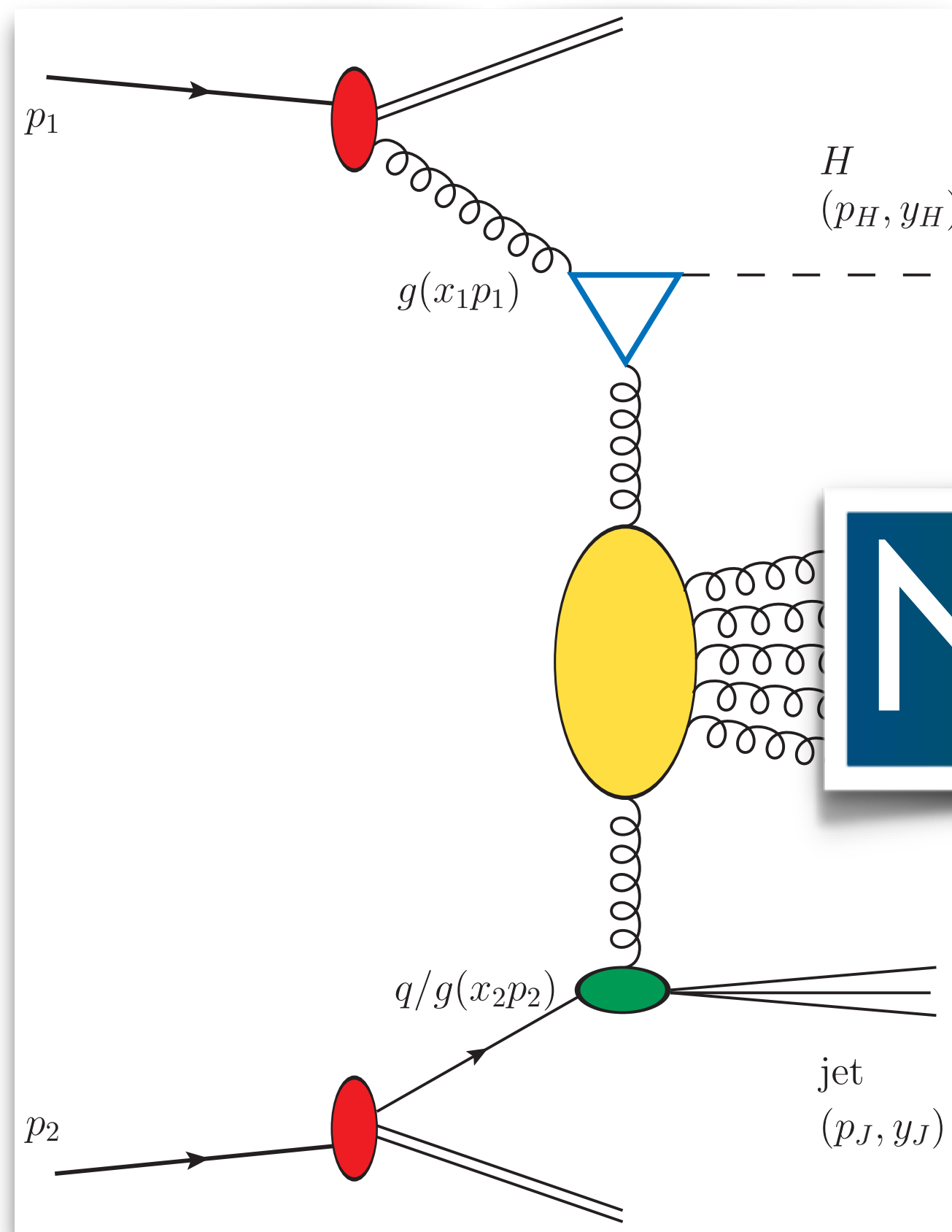

NLL/NLO⁻

(Higgs + jet, NLL/NLO^{*}) [\[F. G. C. et al., Eur. Phys. J. C \(2021\) 8, 780\]](#)
 (NLO emission function) [\[F. G. C., M. Fucilla et al., JHEP 08 \(2022\) 092\]](#)

Z BOSON + JET

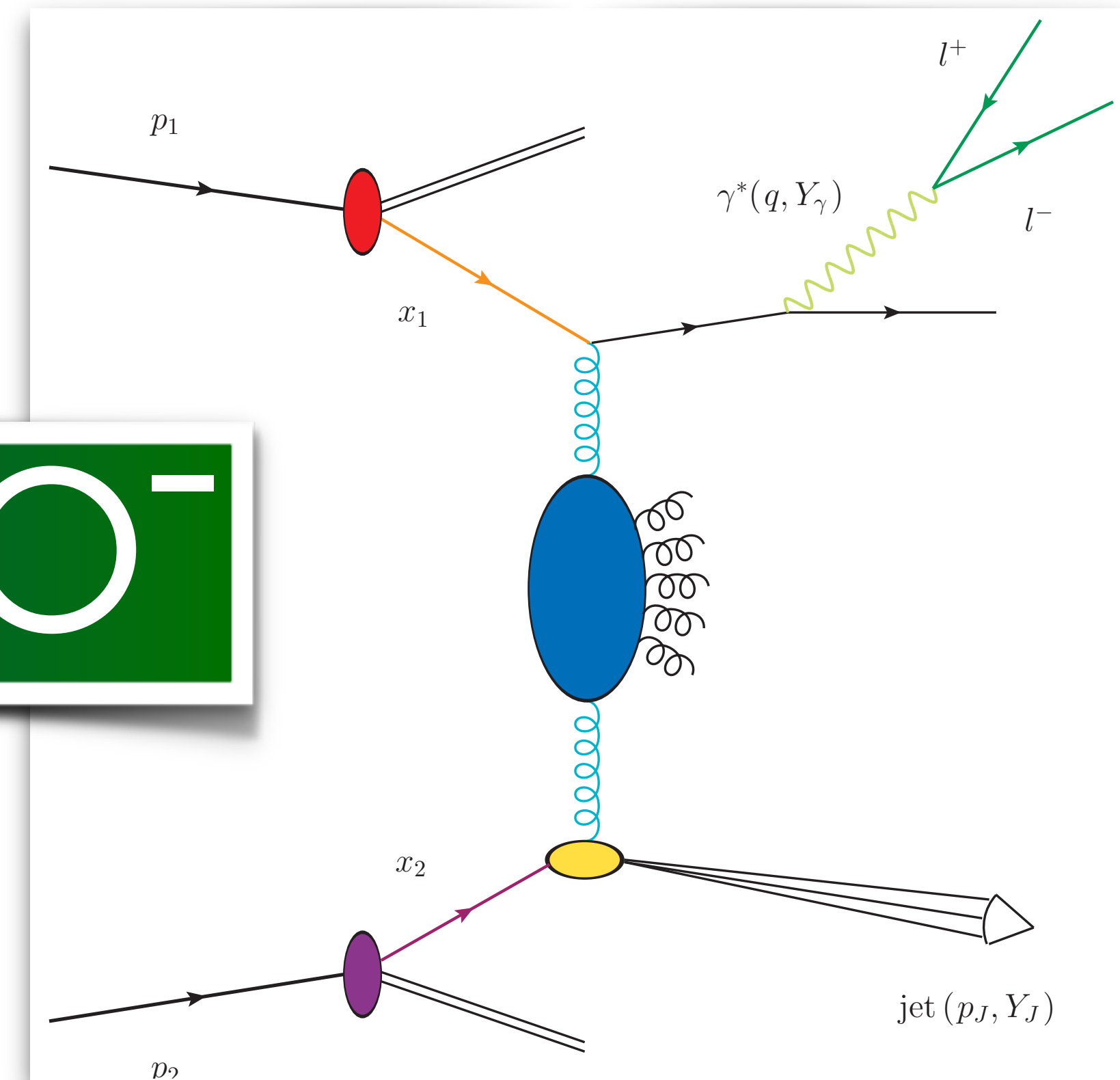

(DY + jet, LL/LO⁺) [\[L. Motyka et al., JHEP 12 \(2018\) 091\]](#)
 (DY and Z + jet, NLL/NLO⁻) [\[F. G. C. et al. \(in progress\)\]](#)

Paving the way towards precision

- ☑ Semi-inclusive **Higgs + jet** as novel probe for **High-Energy QCD**
- ☑ Encouraging statistics for rapidity & transverse-momentum distributions
- ☑ Fair stability under NLL corrections

Paving the way towards precision

- Semi-inclusive **Higgs + jet** as novel probe for **High-Energy QCD**
- Encouraging statistics for rapidity & transverse-momentum distributions
- Fair stability under NLL corrections
- Precision studies \Leftrightarrow NLL/NLO Matching via the **JETHAD** Method
- Systematic uncertainties: top & bottom masses, PDF impact, Matching
- Compare TM spectrum with Parton Shower, then Match/Merge with NLL_{sx} (¿?)
- Higgs + jet** and at **Z + jet** from **NLL/NLO⁻** to **NLL/NLO⁺**



EXTRAS

The JETHAD technology

High-energy resummation

Hunting BFKL

in semi-hard reactions

Mueller-Navelet, light hadrons

ERIS super-module

$$\alpha_s \ln(s) \lesssim 1$$



[\[Eur. Phys. J. C 81 \(2021\) 8, 691\]](#)

[\[Phys. Rev. D 105 \(2022\) 11, 114008\]](#)

Backup

The JETHAD technology

High-energy resummation

Hunting BFKL

in semi-hard reactions

Mueller-Navelet, light hadrons

ERIS super-module

$$\alpha_s \ln(s) \lesssim 1$$

ERIS, Δ_{Navelet} super-modules

Higgs + jet, weak bosons

High-energy resummation

Matching NLL/NLO

In Higgs + jet at the LHC

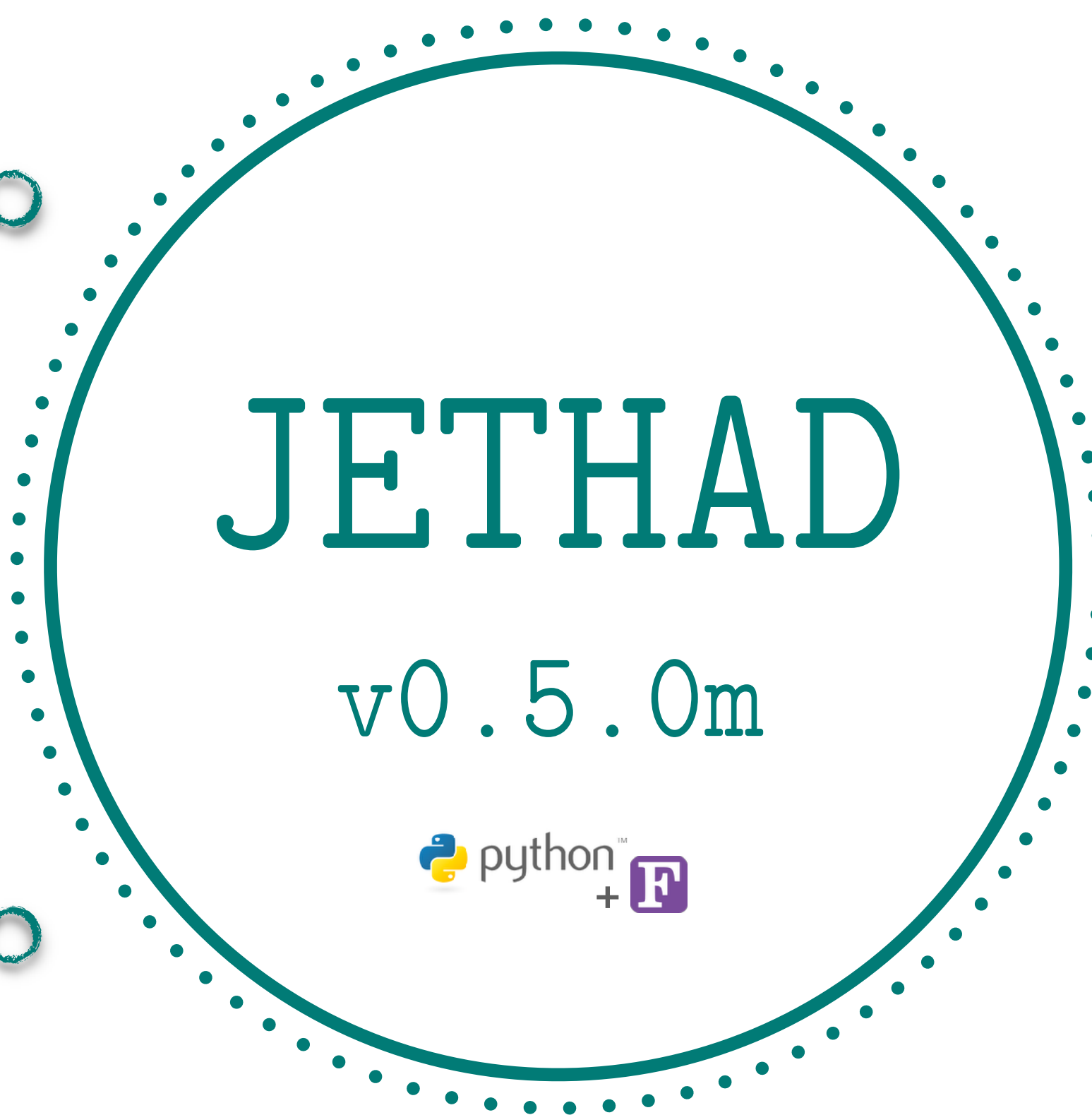

[\[Eur. Phys. J. C 81 \(2021\) 8, 691\]](#)

[\[Phys. Rev. D 105 \(2022\) 11, 114008\]](#)

Backup

The JETHAD technology

High-energy resummation

Hunting BFKL

in semi-hard reactions

Mueller-Navelet, light hadrons
ERIS super-module

$$\alpha_s \ln(s) \lesssim 1$$

ERIS, Δ varis super-modules
Higgs + jet, weak bosons

High-energy resummation

Matching NLL/NLO

In Higgs + jet at the LHC

JETHAD

v0.5.0m



- [\[Eur. Phys. J. C 81 \(2021\) 8, 691\]](#)
- [\[Phys. Rev. D 105 \(2022\) 11, 114008\]](#)

Forward Drell-Yan, onium, Higgs
LExA, HATHOR super-modules

Proton structure

Small-x UGD
Gluon TMD PDFs

Backup

The JETHAD technology

High-energy resummation

Hunting **BFKL**
in semi-hard reactions

Mueller-Navelet, light hadrons
ERIS super-module

$$\alpha_s \ln(s) \lesssim 1$$

ERIS, Δ naumis super-modules
Higgs + jet, weak bosons

High-energy resummation

Matching **NLL/NLO**
In Higgs + jet at the LHC



Quarkonium studies
from low to high p_T
NRFF1.0 onium FFs

Vectors & pseudoscalars
JETHAD + DGLAP evolution operators

Forward Drell-Yan, onium, Higgs
LExA, HATHOR super-modules

Proton structure

Small-x UGD
Gluon TMD PDFs

JETHAD

v0.5.0m



- [\[Eur. Phys. J. C 81 \(2021\) 8, 691\]](#)
- [\[Phys. Rev. D 105 \(2022\) 11, 114008\]](#)

Backup

The JETHAD technology

High-energy resummation

Hunting **BFKL**
in semi-hard reactions

Mueller-Navelet, light hadrons
ERIS super-module

$$\alpha_s \ln(s) \lesssim 1$$

ERIS, Δ naumis super-modules
Higgs + jet, weak bosons

High-energy resummation

Matching **NLL/NLO**
In Higgs + jet at the LHC



Quarkonium studies
from low to high p_T
NRFF1.0 onium FFs

Vectors & pseudoscalars
JETHAD + DGLAP evolution operators



Forward Drell-Yan, onium, Higgs
LExA, HATHOR super-modules

Proton structure

Small-x UGD
Gluon TMD PDFs

- [\[Eur. Phys. J. C 81 \(2021\) 8, 691\]](#)
- [\[Phys. Rev. D 105 \(2022\) 11, 114008\]](#)

Backup

Effect of collinear improvement on NLL BFKL kernel

Backup

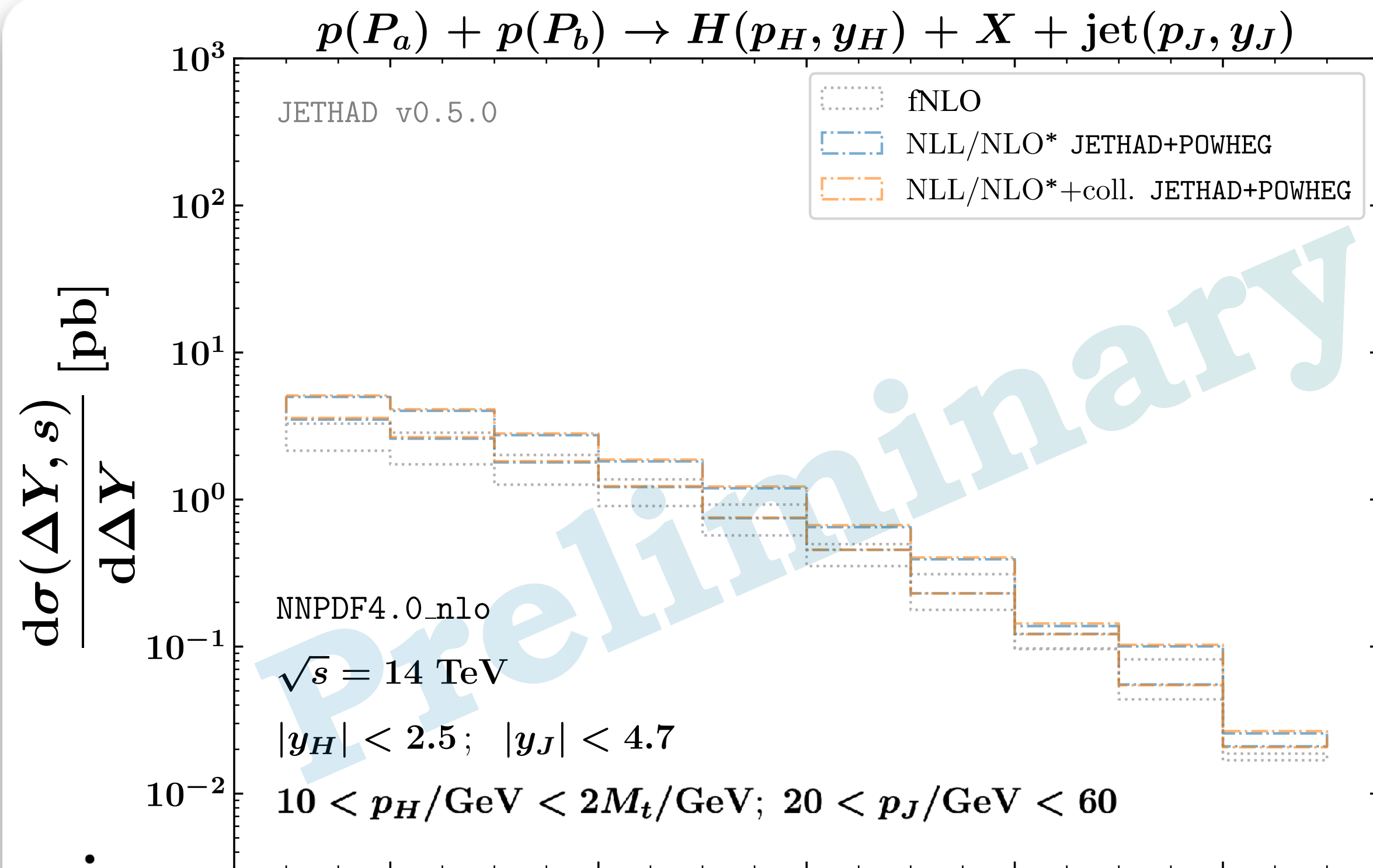

match./f.o.

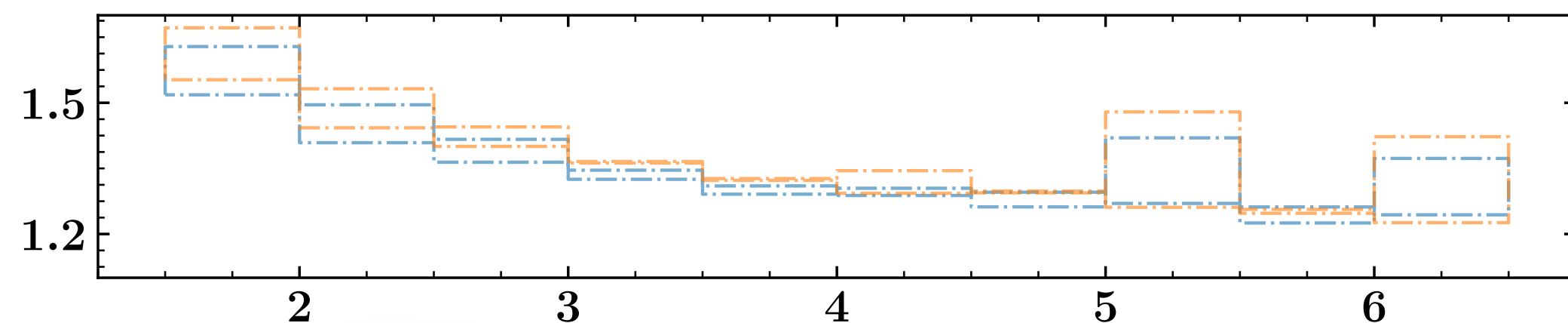

@14 TeV LHC

$\Delta Y = y_H - y_J$

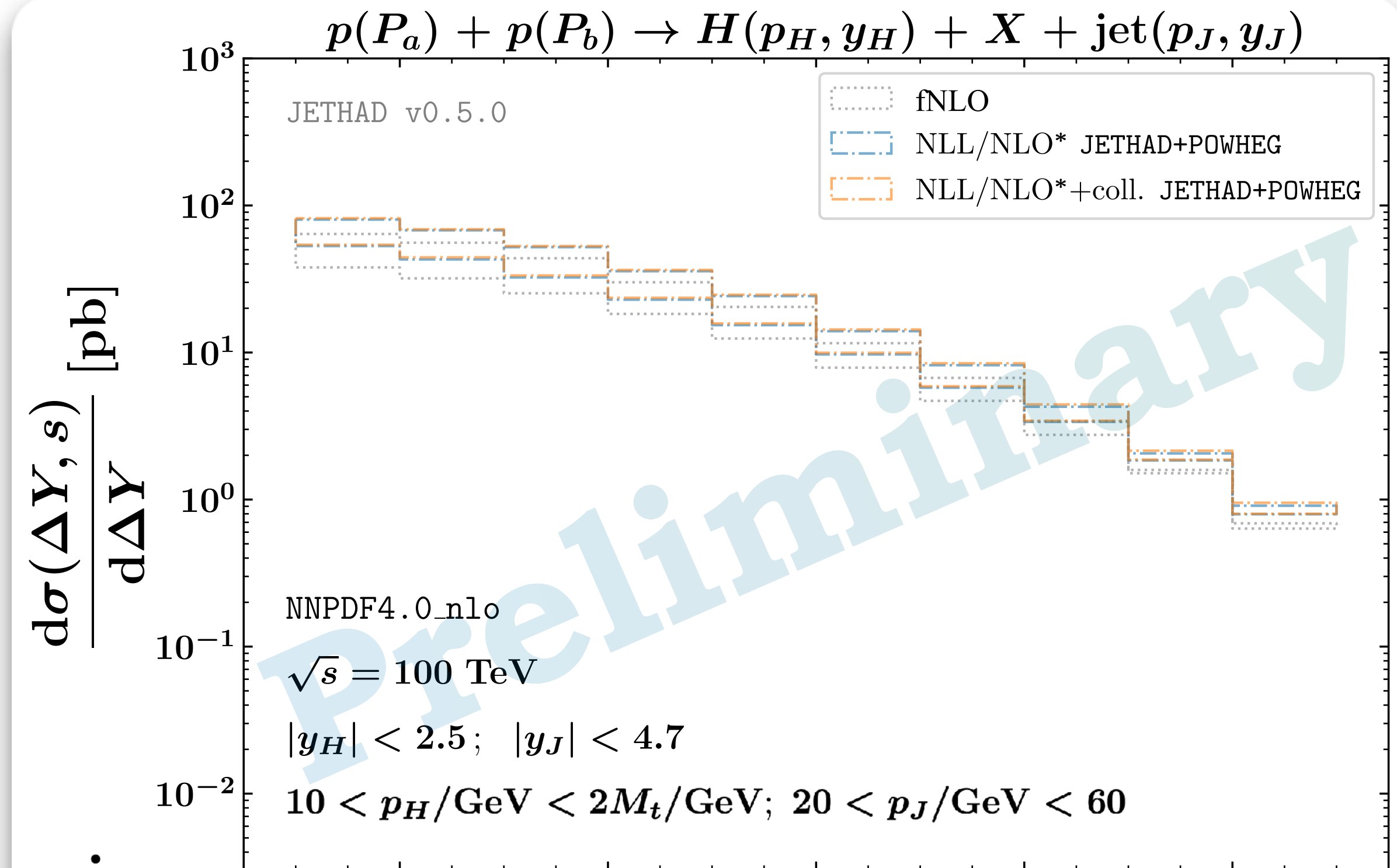

match./f.o.

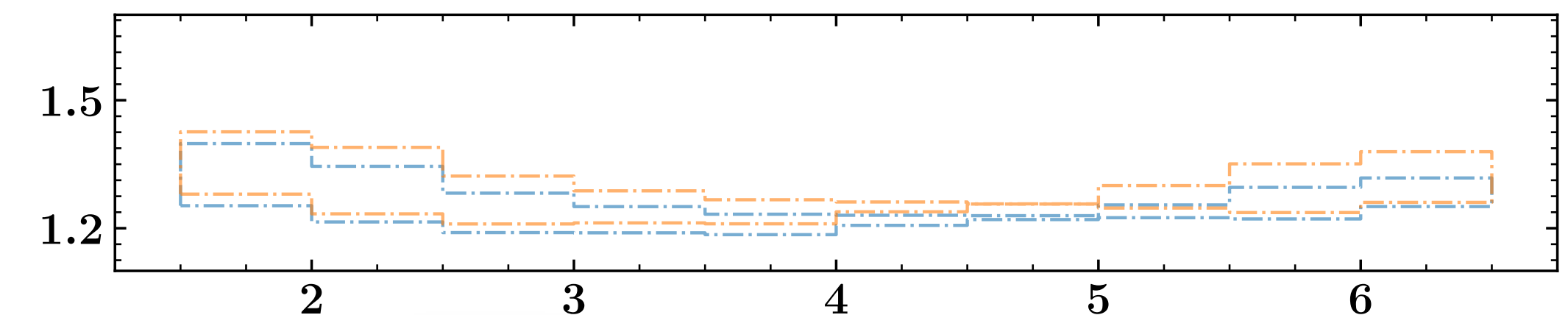

@100 TeV FCC

$\Delta Y = y_H - y_J$

(Collinear improvement) [\[G.P. Salam, JHEP 07 \(1998\) 019\]](#); [\[M. Ciafaloni et al., Phys.Lett.B 587 \(2004\) 87-94\]](#); [\[A. Sabio Vera, Nucl.Phys.B 722 \(2005\) 65-80\]](#)



Effect of ABF-stabilized kernel [\[to be gauged\]](#)

The Higgs + jet spectrum from POWHEG + JETHAD

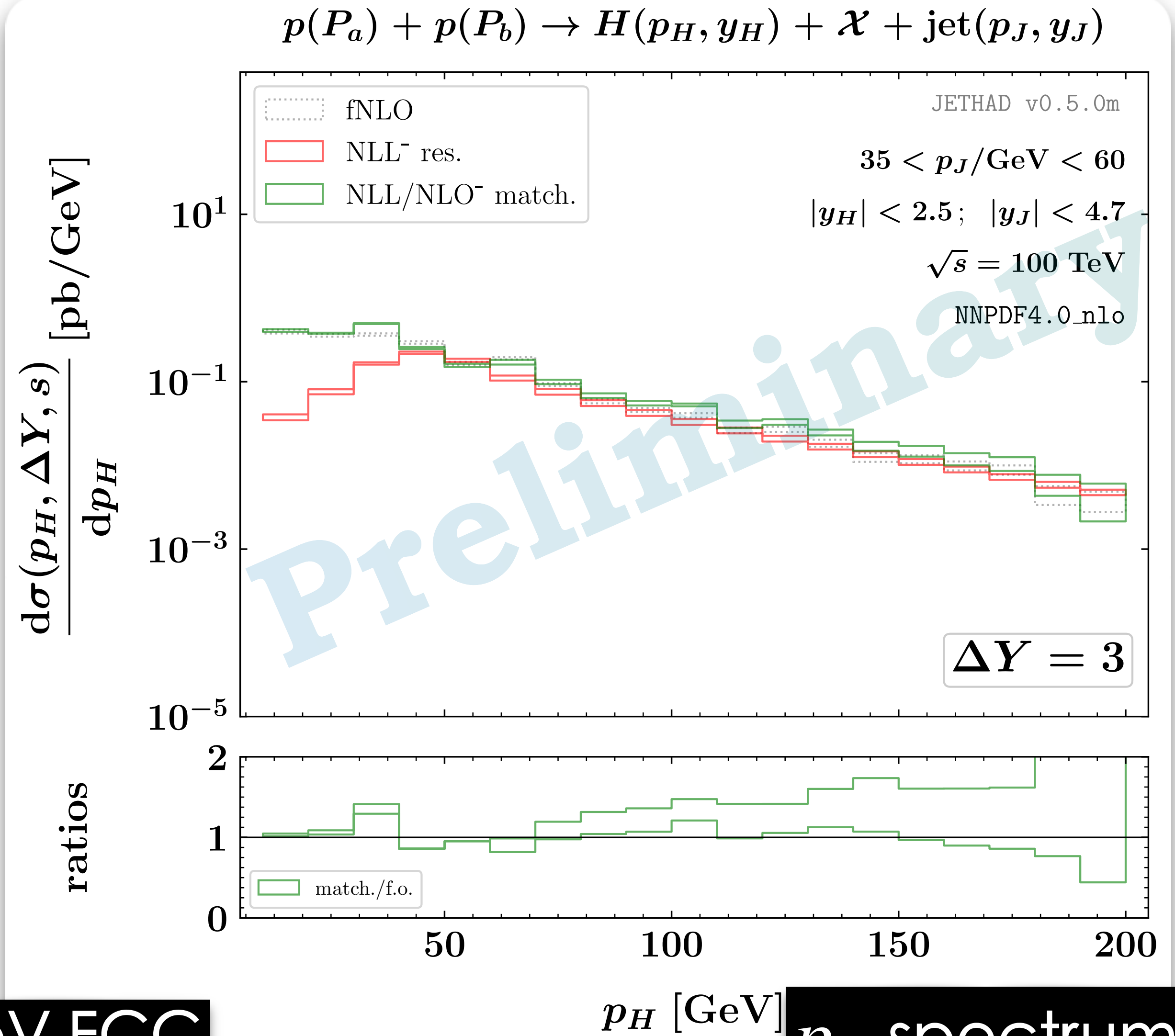
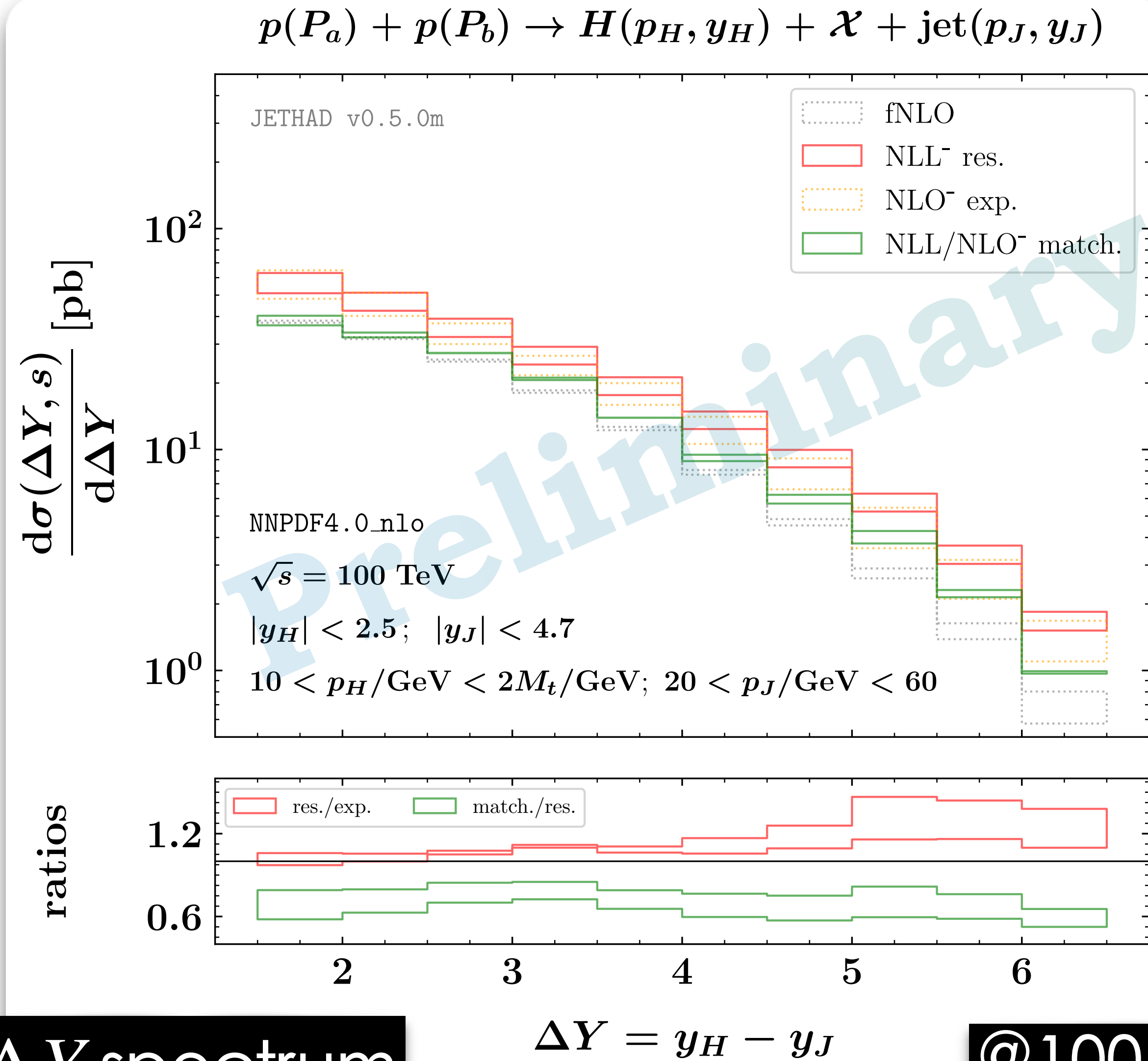

ΔY spectrum

@100 TeV FCC

p_H spectrum

Backup

NLL matched to NLO fixed-order JETHAD + POWHEG (in progress)

$$\text{proton}(p_1) + \text{proton}(p_2) \rightarrow H(|\vec{p}_H|, y_H) + X + \text{jet}(|\vec{p}_J|, y_J)$$

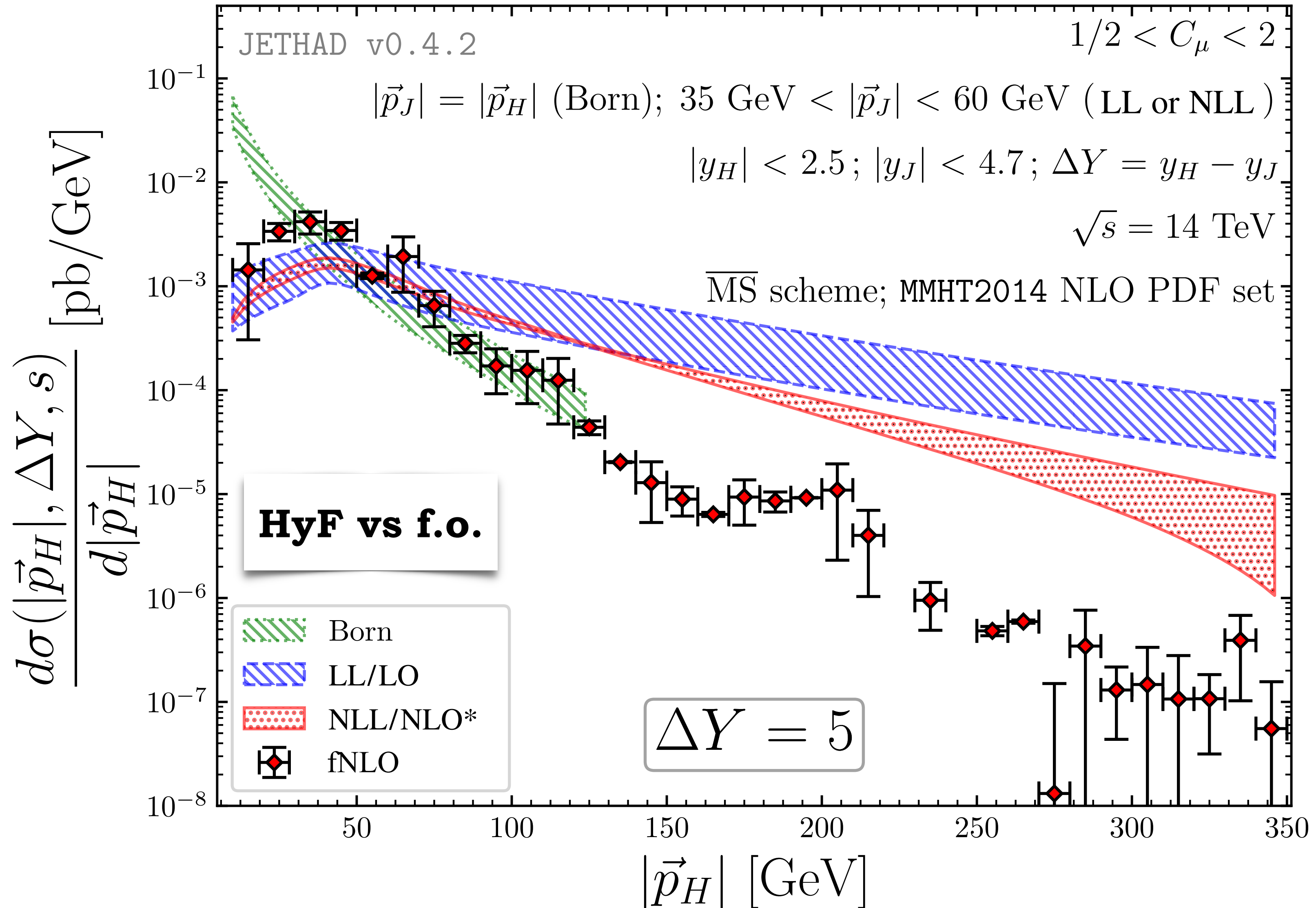

Backup

large p_T logs
 p_T -resum. needed

$$\text{proton}(p_1) + \text{proton}(p_2) \rightarrow H(|\vec{p}_H|, y_H) + X + \text{jet}(|\vec{p}_J|, y_J)$$

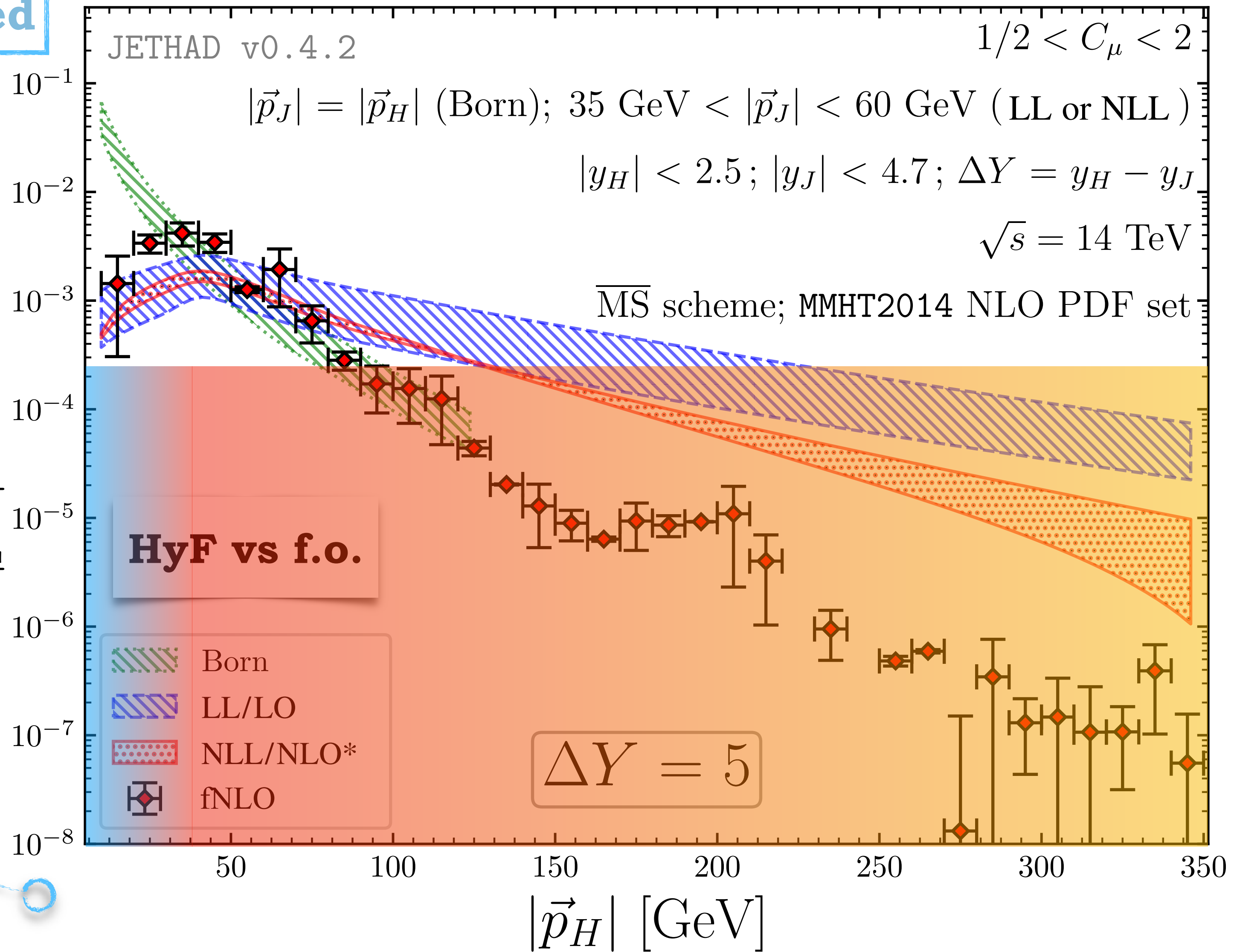

Backup

large p_T logs
 p_T -resum. needed

$$\text{proton}(p_1) + \text{proton}(p_2) \rightarrow H(|\vec{p}_H|, y_H) + X + \text{jet}(|\vec{p}_J|, y_J)$$

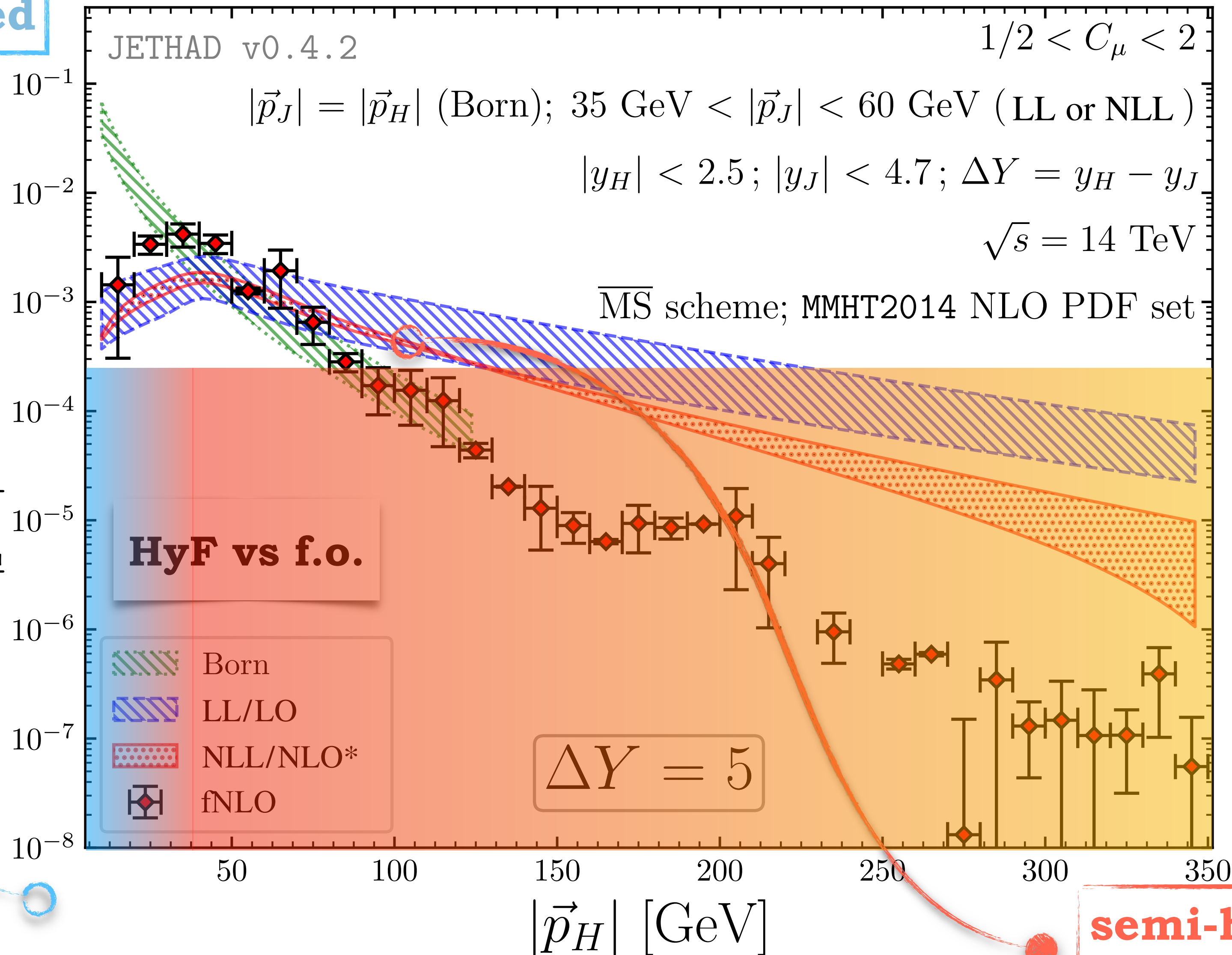

Backup

DGLAP-type + large- x threshold logs \rightarrow BFKL decoupling

large p_T logs
 p_T -resum. needed

$$\text{proton}(p_1) + \text{proton}(p_2) \rightarrow H(|\vec{p}_H|, y_H) + X + \text{jet}(|\vec{p}_J|, y_J)$$

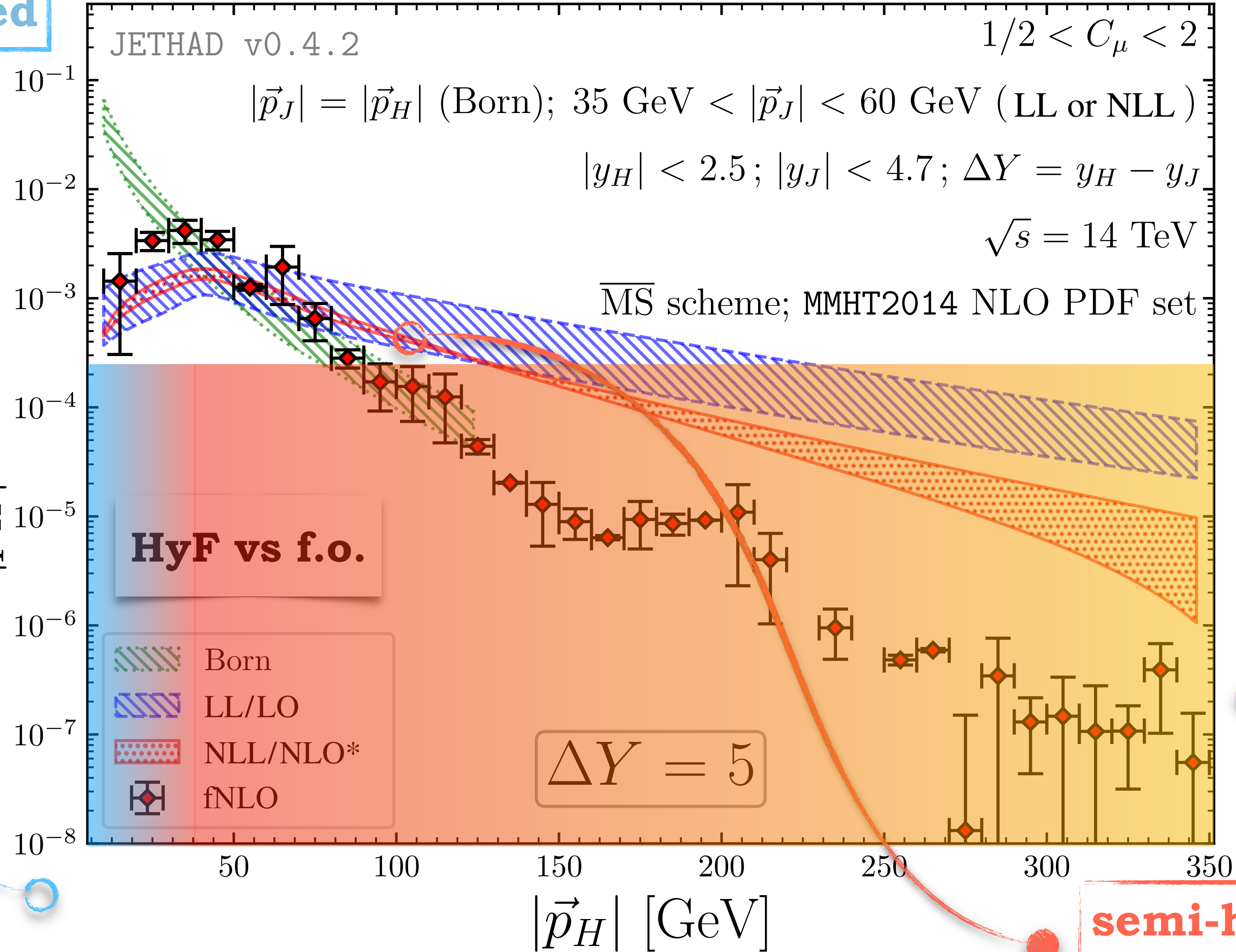

**semi-hard regime
 BFKL expected**

Backup

DGLAP-type + large- x threshold logs \rightarrow BFKL decoupling

large p_T logs
 p_T -resum. needed

$$\text{proton}(p_1) + \text{proton}(p_2) \rightarrow H(|\vec{p}_H|, y_H) + X + \text{jet}(|\vec{p}_J|, y_J)$$

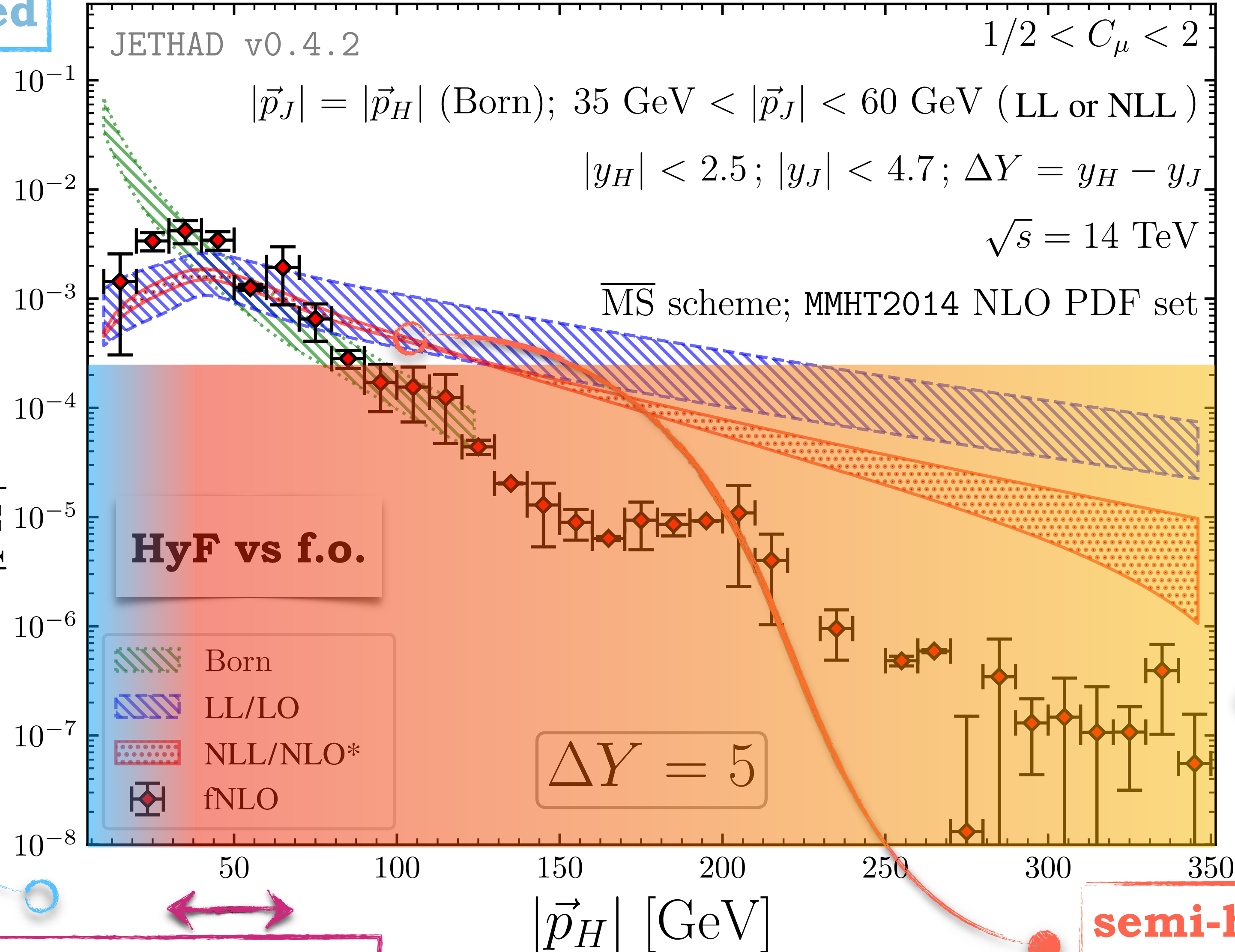

Backup

$$\frac{d\sigma(|\vec{p}_H|, \Delta Y, s)}{d|\vec{p}_H|} \text{ [pb/GeV]}$$

almost back-to-back emissions
 large imbalance double logs

semi-hard regime
 BFKL expected

(Higgs + jet, NLL/NLO* HyF) [F. G. C. et al., Eur. Phys. J. C (2021) 8, 780]

$$\text{proton}(p_1) + \text{proton}(p_2) \rightarrow H(|\vec{p}_H|, y_H) + X + \text{jet}(|\vec{p}_J|, y_J)$$

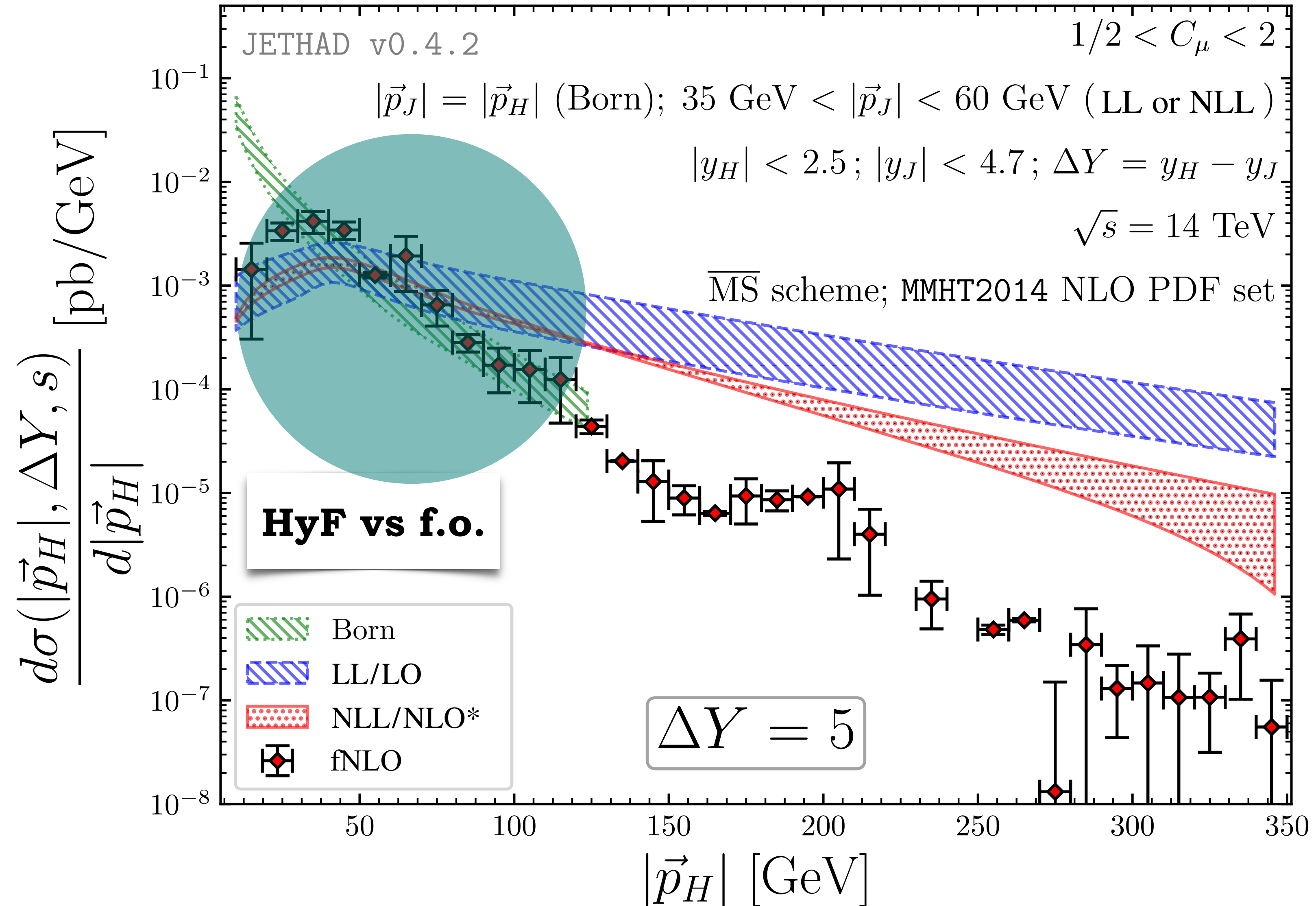

Backup

! Precision corrections *expected*

$$\text{proton}(p_1) + \text{proton}(p_2) \rightarrow H(|\vec{p}_H|, y_H) + X + \text{jet}(|\vec{p}_J|, y_J)$$

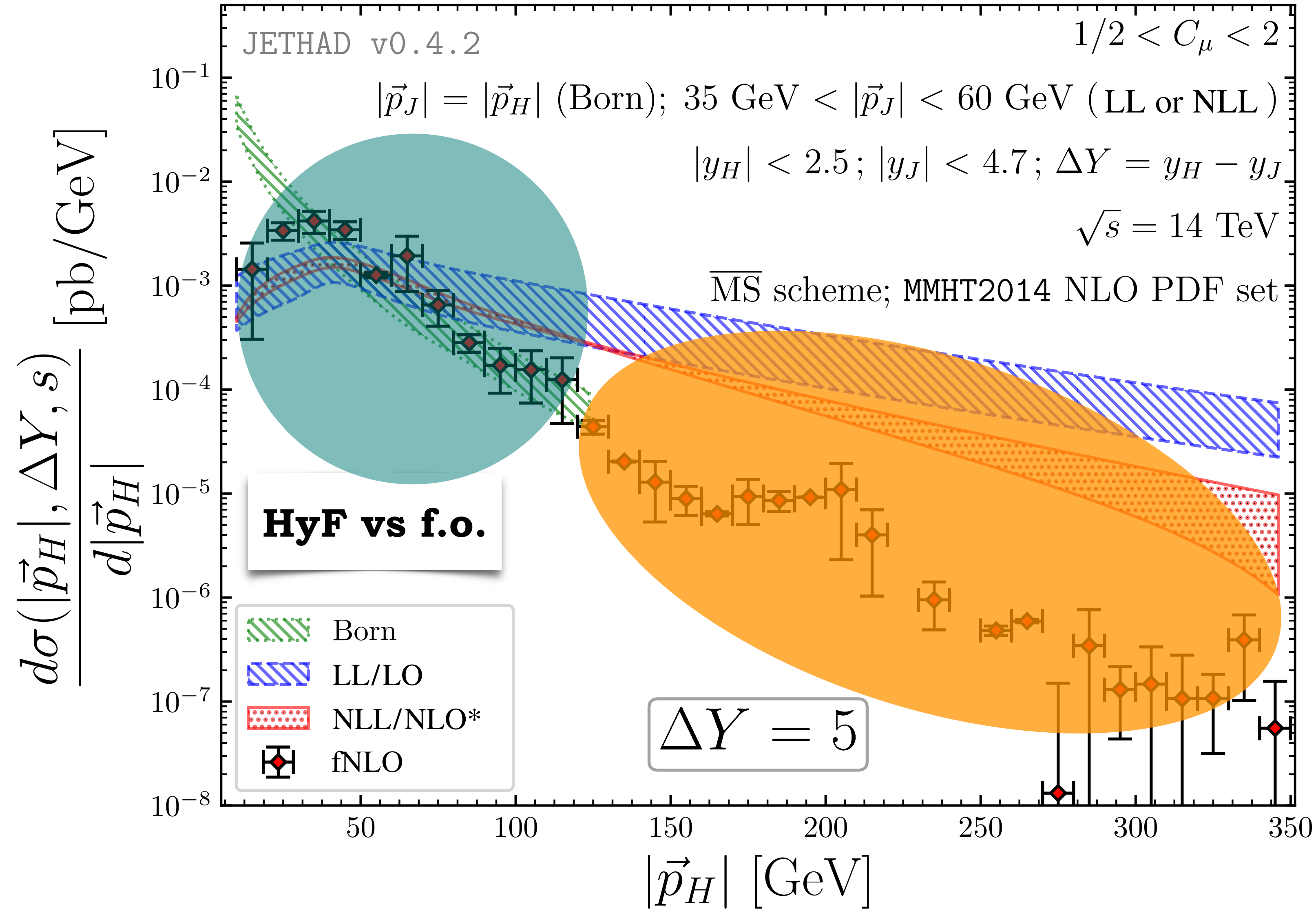

Backup

! Precision corrections *expected*, but **HyF** *predicts* large deviations from **f.o.** !

High-energy factorization at a glance

Singly/double off-shell coefficient functions
Forward/central production emission functions

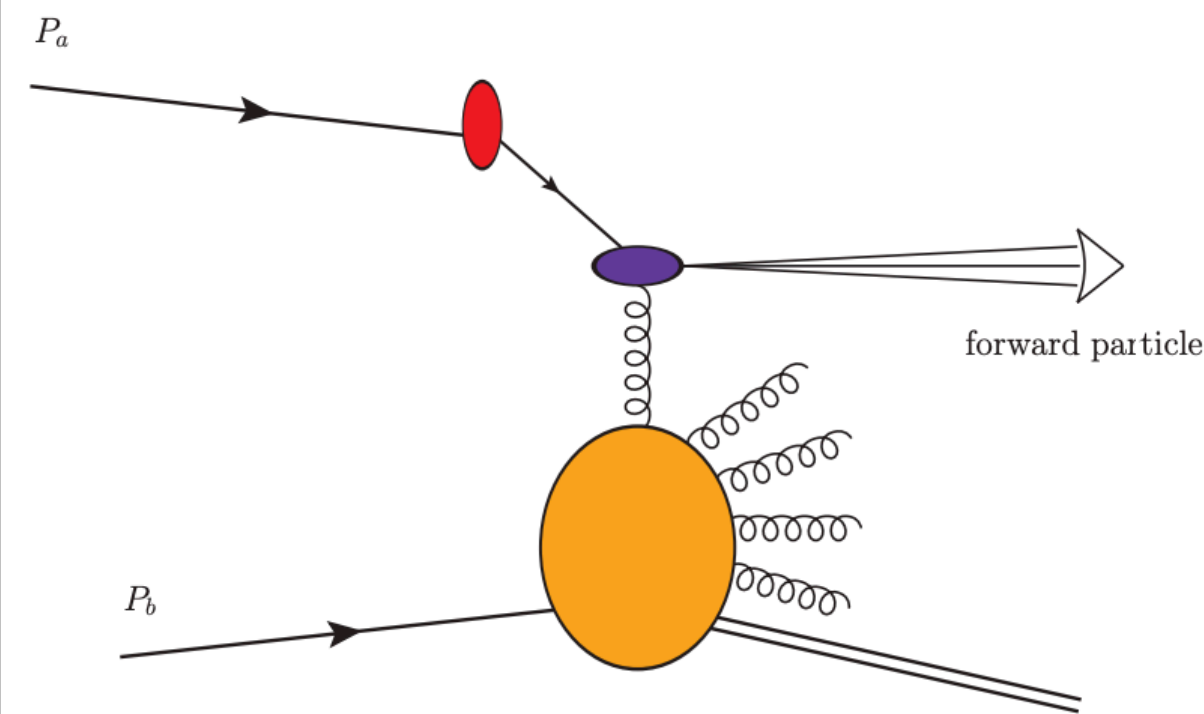

(a) Single forward

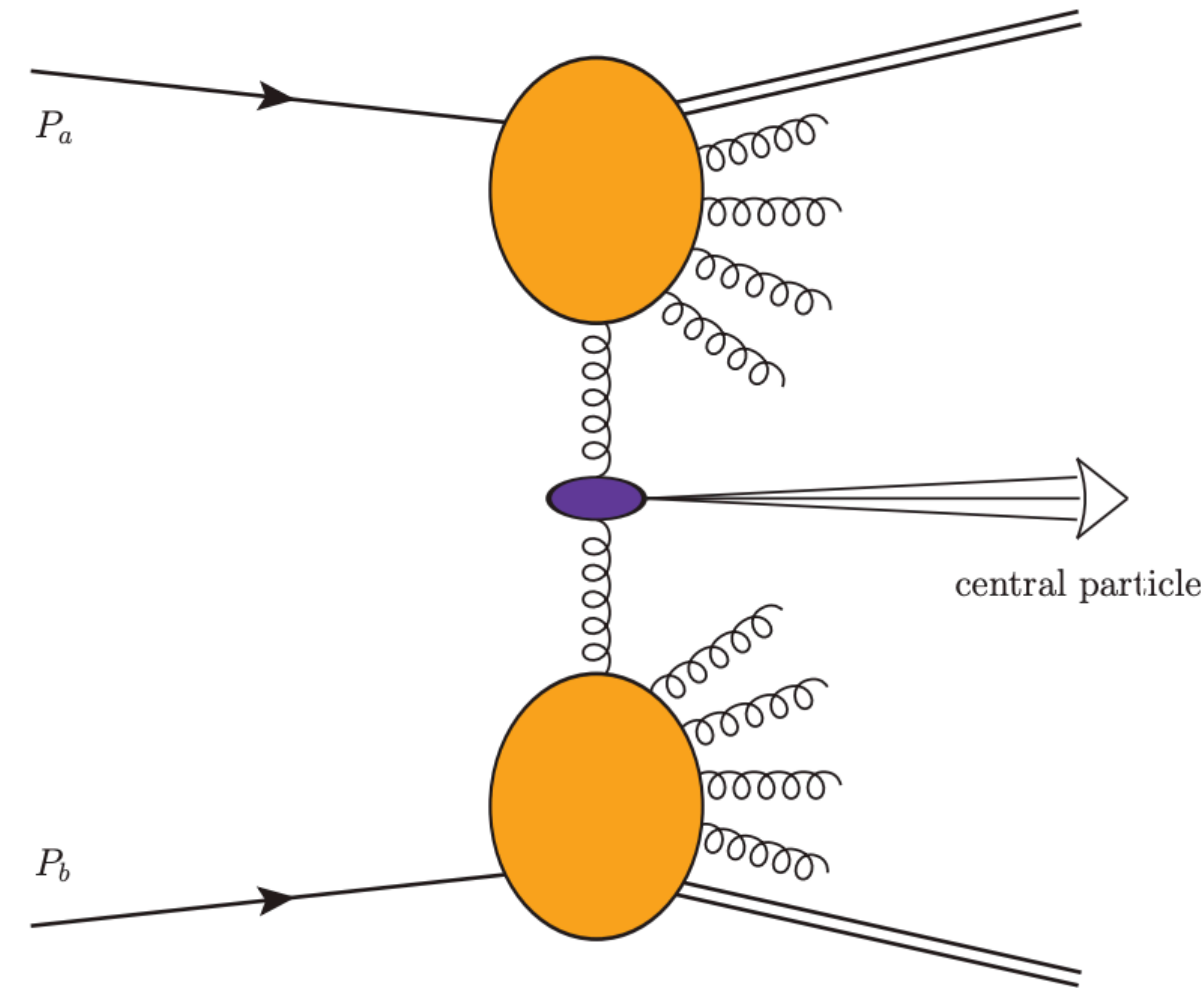

(b) Single central

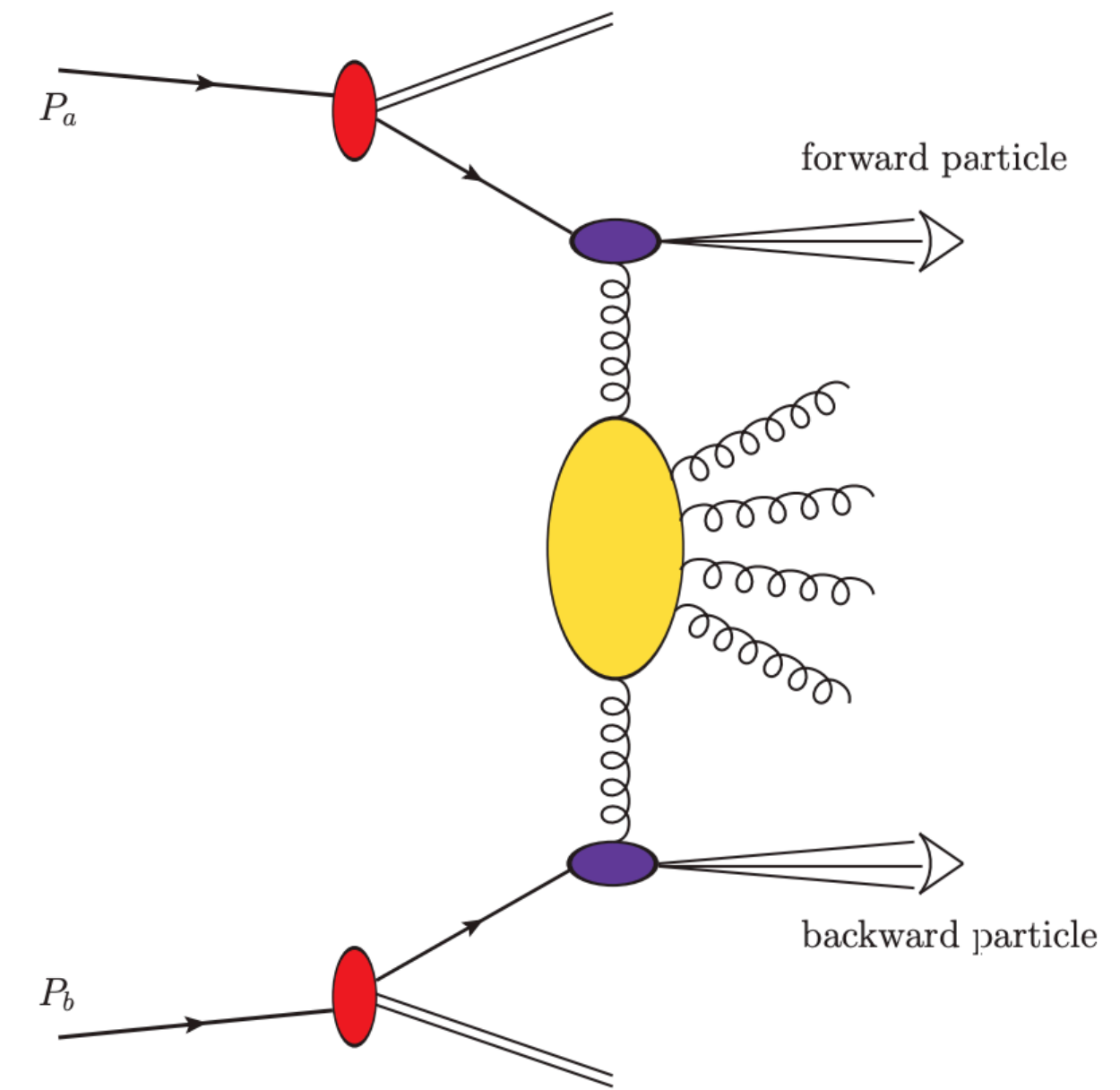

(c) Forward-backward

High-energy factorization at a glance

Singly/double off-shell coefficient functions
 Forward/central production emission functions

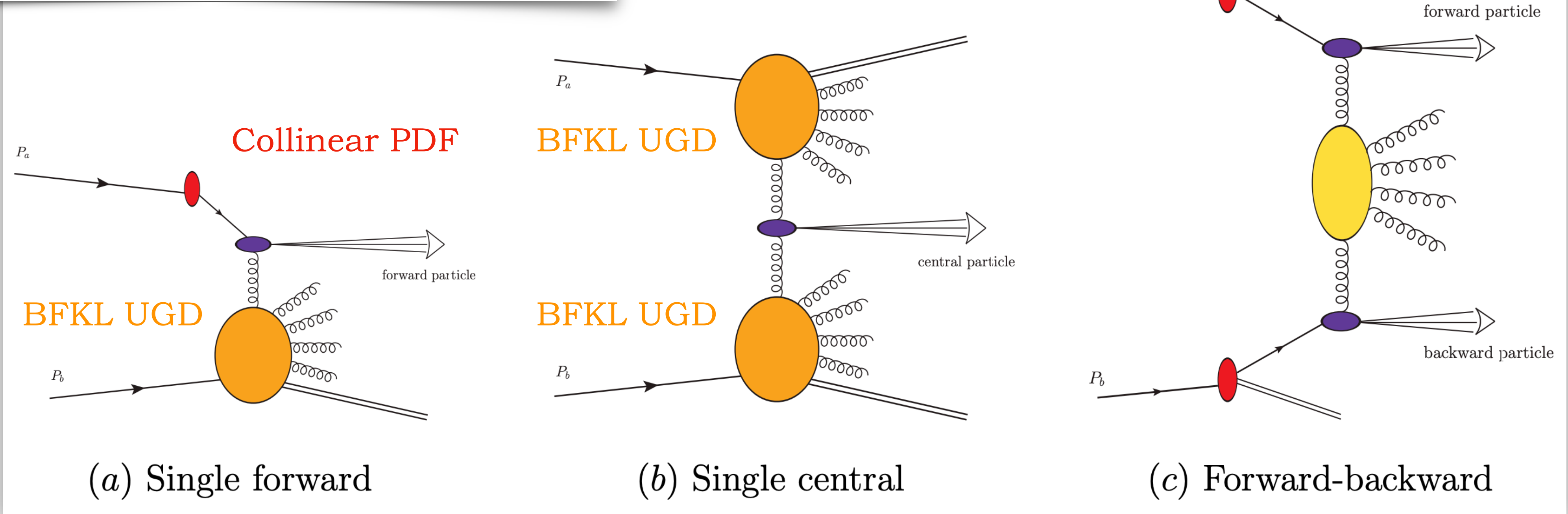

Fast q/g + small- x g

Hybrid factorization

BFKL + Threshold

gg induced

High-energy factorization

BFKL or small- x improved PDFs

[M. Bonvini, S. Marzani (2018)]

High-energy factorization at a glance

Singly/double off-shell coefficient functions
Forward/central production emission functions

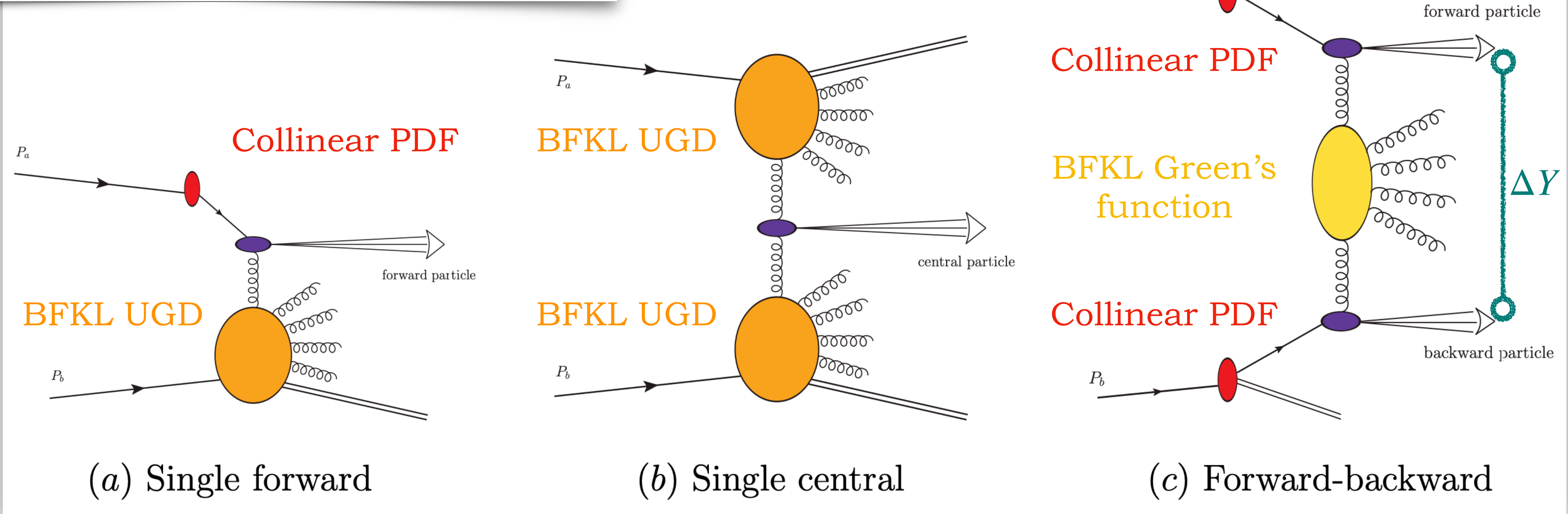

Fast q/g + small- x g

Hybrid factorization

BFKL + Threshold

gg induced

High-energy factorization

BFKL or small- x improved PDFs

[M. Bonvini, S. Marzani (2018)]

Large rapidity distances, $\Delta Y \gg 1$

High energies, moderate x

PDFs + t-channel BFKL (NLL/NLO HyF)

Imbalance logs \leftarrow back-to-back

Mueller-Navelet jets @LHC & resummation instabilities

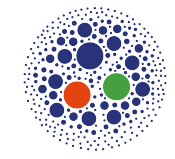

Inclusive hadroproduction of two jets with high p_T and large rapidity separation, ΔY

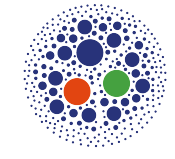

Moderate x (**collinear PDFs**), but t-channel p_T (**BFKL resummation**) \Rightarrow hybrid factorization (HyF)

$$\frac{d\sigma}{dy_1 dy_2 d^2\vec{k}_1 d^2\vec{k}_2} = \sum_{r,s=q,g} \int_0^1 dx_1 \int_0^1 dx_2 f_r(x_1, \mu_F) f_s(x_2, \mu_F) \frac{d\hat{\sigma}_{r,s}(x_1 x_2 s, \mu_F)}{dy_1 dy_2 d^2\vec{k}_1 d^2\vec{k}_2}$$

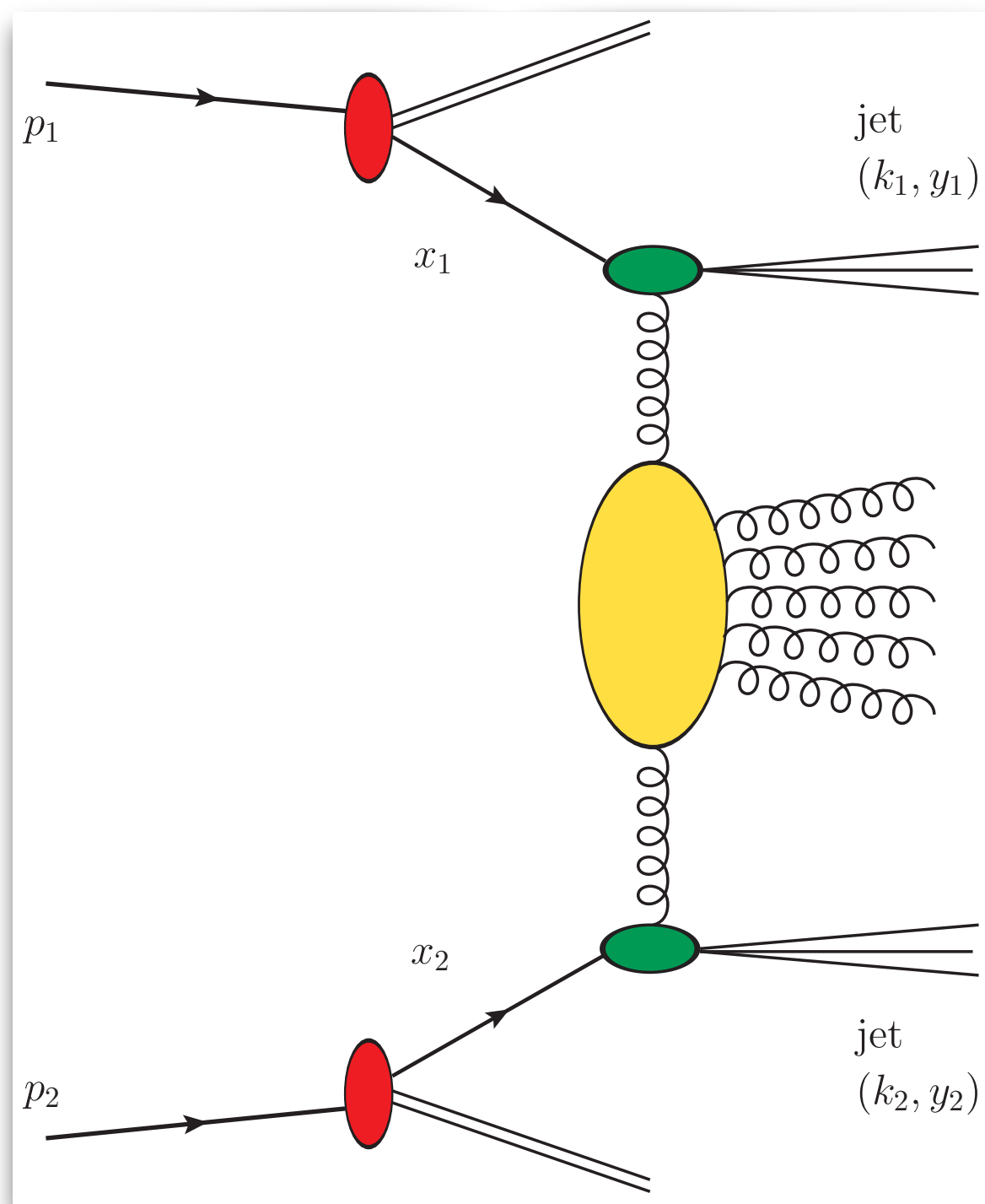

Mueller-Navelet jets @LHC & resummation instabilities

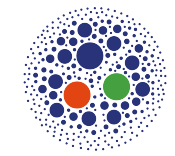

Inclusive hadroproduction of two jets with high p_T and large rapidity separation, ΔY

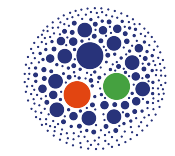

Moderate x (**collinear PDFs**), but t-channel p_T (**BFKL resummation**) \Rightarrow **hybrid factorization (HyF)**

$$\frac{d\sigma}{dy_1 dy_2 d^2\vec{k}_1 d^2\vec{k}_2} = \sum_{r,s=q,g} \int_0^1 dx_1 \int_0^1 dx_2 f_r(x_1, \mu_F) f_s(x_2, \mu_F) \frac{d\hat{\sigma}_{r,s}(x_1 x_2 s, \mu_F)}{dy_1 dy_2 d^2\vec{k}_1 d^2\vec{k}_2}$$

jet vertices
(off-shell coefficient functions)

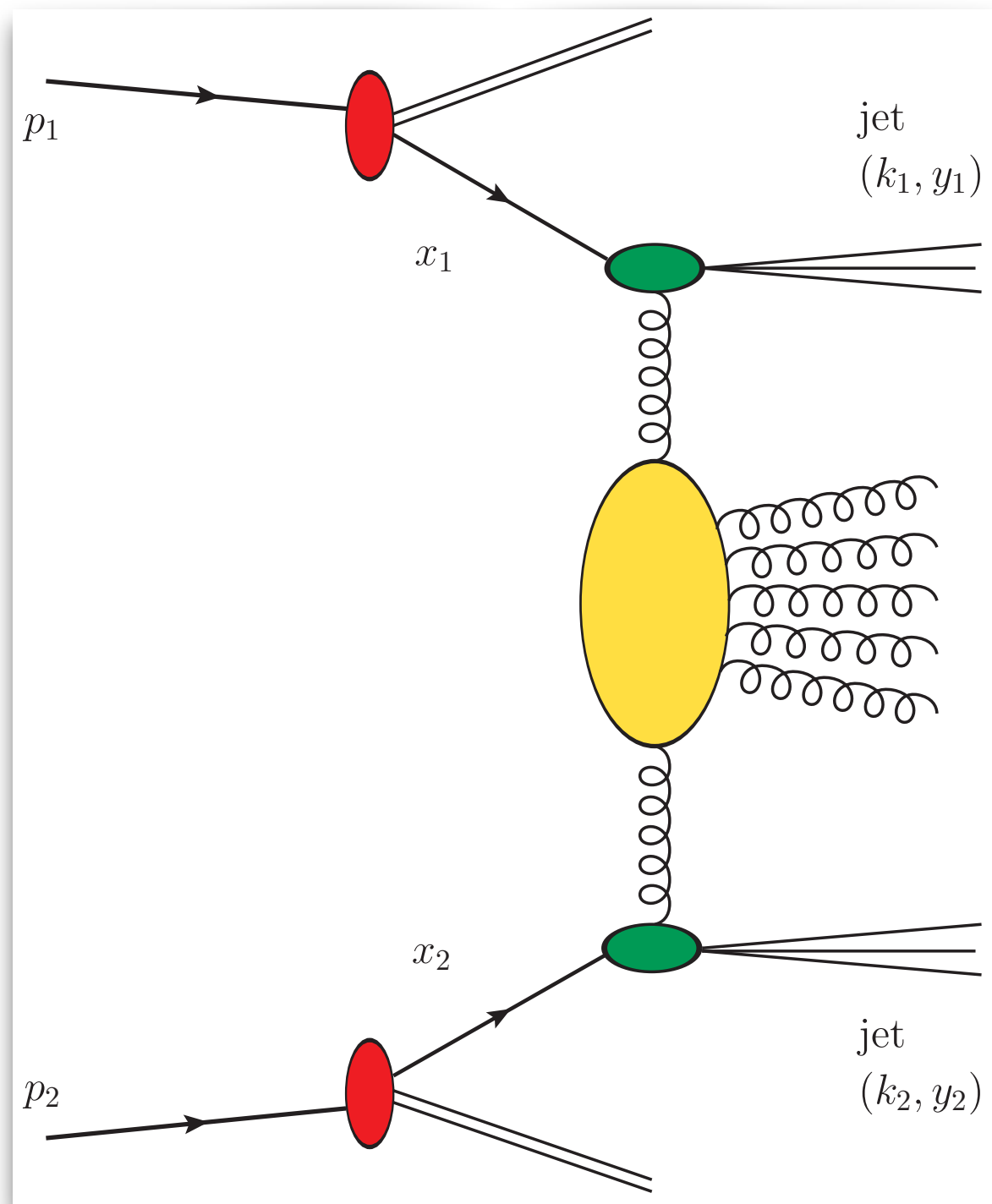

NLO(+)

NLL

NLO(+)

$$\frac{d\hat{\sigma}_{r,s}(x_1 x_2 s, \mu)}{dy_1 dy_2 d^2\vec{k}_1 d^2\vec{k}_2} = \frac{1}{(2\pi)^2}$$

$$\times \int \frac{d^2\vec{q}_1}{\vec{q}_1^2} \mathcal{V}_J^{(r)}(\vec{q}_1, s_0, x_1, \vec{k}_1)$$

$$\times \int_{\delta-i\infty}^{\delta+i\infty} \frac{d\omega}{2\pi i} \left(\frac{x_1 x_2 s}{s_0} \right)^\omega \mathcal{G}_\omega(\vec{q}_1, \vec{q}_2)$$

$$\times \int \frac{d^2\vec{q}_2}{\vec{q}_2^2} \mathcal{V}_J^{(s)}(\vec{q}_2, s_0, x_2, \vec{k}_2)$$

BFKL Green's function

Mueller-Navelet jets @LHC & resummation instabilities

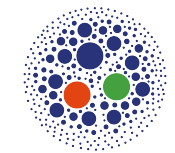

Inclusive hadroproduction of two jets with high p_T and large rapidity separation, ΔY

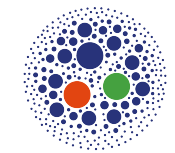

Moderate x (**collinear PDFs**), but t-channel p_T (**BFKL resummation**) \Rightarrow **hybrid factorization (HyF)**

$$\frac{d\sigma}{dy_1 dy_2 d^2\vec{k}_1 d^2\vec{k}_2} = \sum_{r,s=q,g} \int_0^1 dx_1 \int_0^1 dx_2 f_r(x_1, \mu_F) f_s(x_2, \mu_F) \frac{d\hat{\sigma}_{r,s}(x_1 x_2 s, \mu_F)}{dy_1 dy_2 d^2\vec{k}_1 d^2\vec{k}_2}$$

jet vertices
(off-shell coefficient functions)

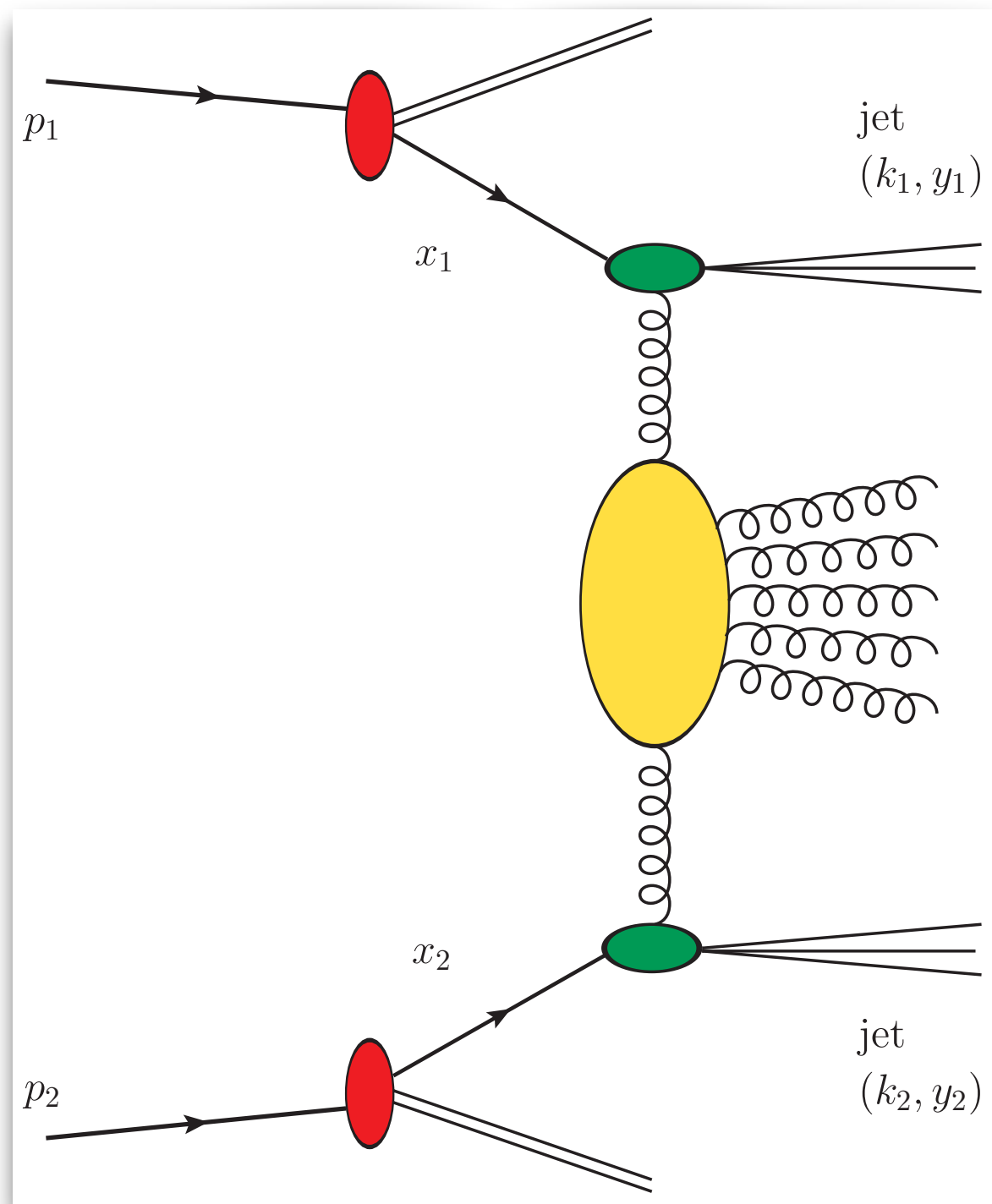

NLO(+)

NLL

NLO(+)

$$\frac{d\hat{\sigma}_{r,s}(x_1 x_2 s, \mu)}{dy_1 dy_2 d^2\vec{k}_1 d^2\vec{k}_2} = \frac{1}{(2\pi)^2}$$

$$\times \int \frac{d^2\vec{q}_1}{\vec{q}_1^2} \mathcal{V}_J^{(r)}(\vec{q}_1, s_0, x_1, \vec{k}_1)$$

$$\times \int_{\delta-i\infty}^{\delta+i\infty} \frac{d\omega}{2\pi i} \left(\frac{x_1 x_2 s}{s_0}\right)^\omega \mathcal{G}_\omega(\vec{q}_1, \vec{q}_2)$$

$$\times \int \frac{d^2\vec{q}_2}{\vec{q}_2^2} \mathcal{V}_J^{(s)}(\vec{q}_2, s_0, x_2, \vec{k}_2)$$



BFKL Green's function



NLL/LL instabilities + NLO missing **threshold** \Rightarrow **precision studies hampered**

Backup

Mueller-Navelet jets @LHC & resummation instabilities

-  Strong manifestation of **higher-order instabilities** via scale variation (i!)
-  i At natural scales: NLL/LL ratio large, no agreement with data, unphysical values !
-  **BLM** scales, theory vs experiment: CMS @7TeV with **symmetric** p_T -ranges, only

Mueller-Navelet jets @LHC & resummation instabilities

- Strong manifestation of **higher-order instabilities** via scale variation (!!)
- ! At natural scales: NLL/LL ratio large, no agreement with data, unphysical values !
- BLM** scales, theory vs experiment: CMS @7TeV with **symmetric** p_T-ranges, only

[CMS Collaboration, JHEP 08 (2016) 139]

[B. Ducloué et al., Phys. Rev. Lett. 112 (2014) 082003]

[F. Caporale et al., Eur. Phys. J. C 74 (2014) 10, 3084]

(left figure) [F. G. C., A. Papa, Phys. Rev. D 106 (2022) 11, 114004]

(right figure) [F. G. C., Eur. Phys. J. C 81 (2021) 8, 691]

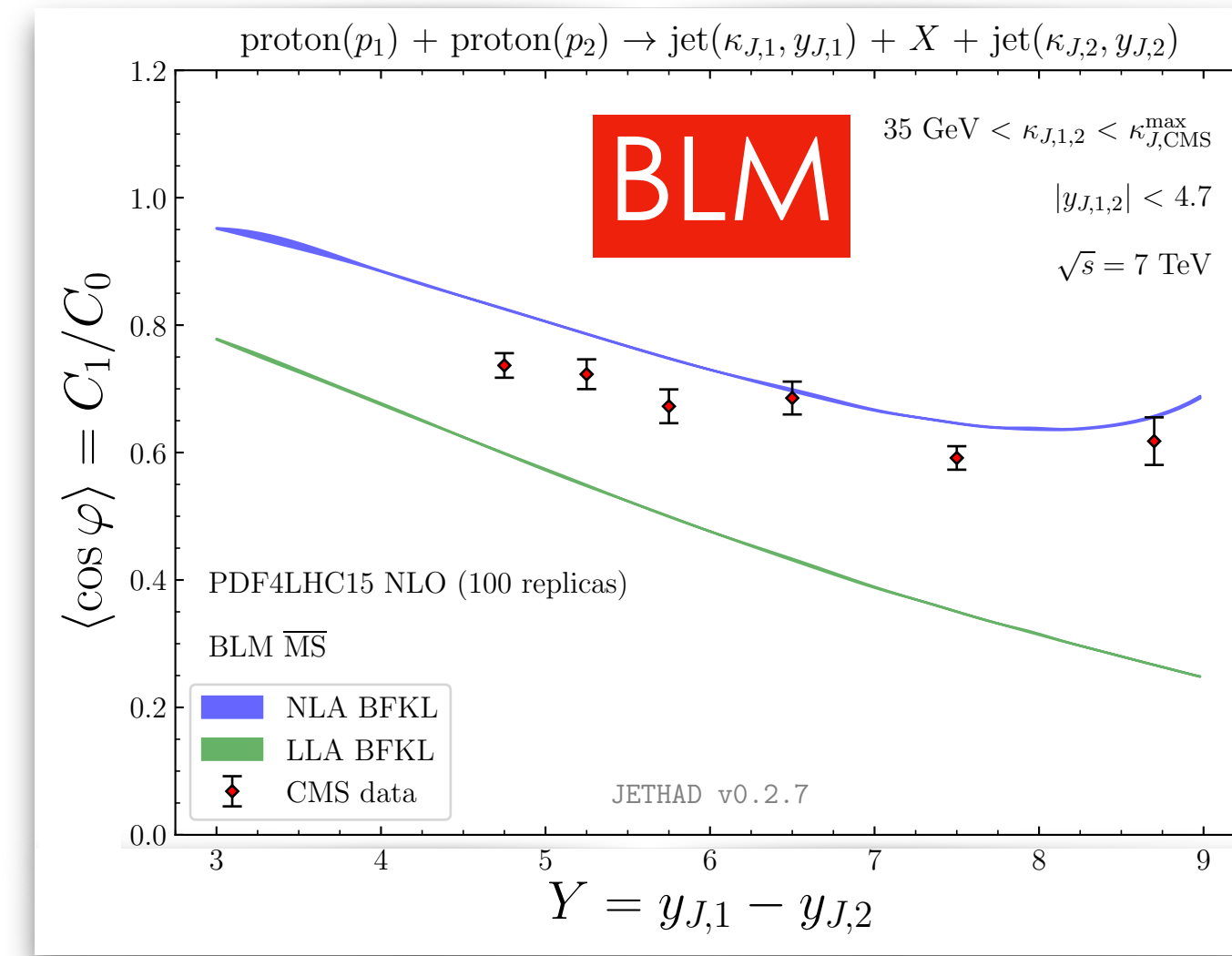
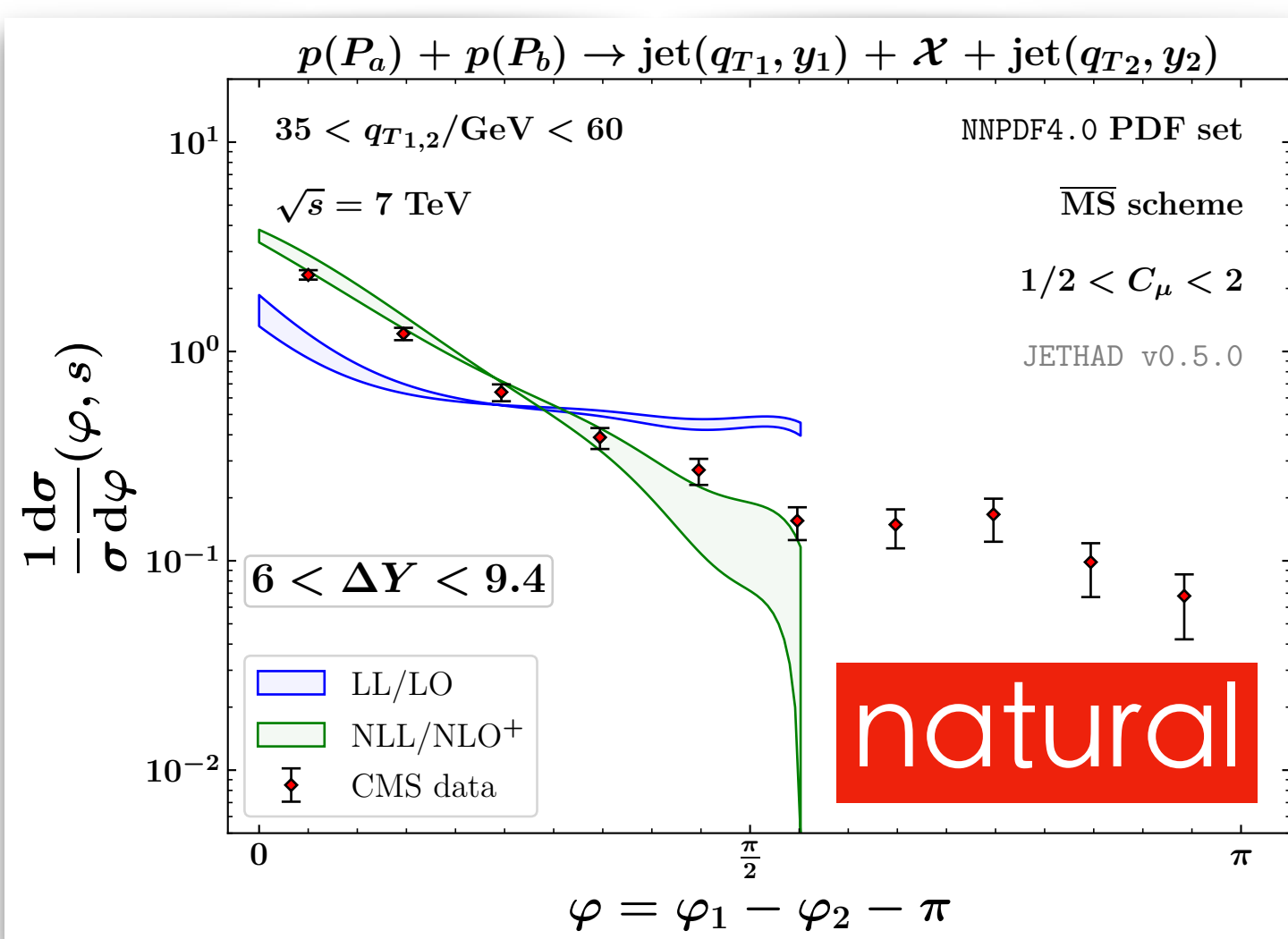

Mueller-Navelet jets @LHC & resummation instabilities

- Strong manifestation of **higher-order instabilities** via scale variation (⚠️)
- ⚠️ At natural scales: NLL/LL ratio large, no agreement with data, unphysical values !
- BLM** scales, theory vs experiment: CMS @7TeV with **symmetric** p_T-ranges, only

🔗 [CMS Collaboration, JHEP 08 (2016) 139]

🔗 [B. Ducloué et al., Phys. Rev. Lett. 112 (2014) 082003]

🔗 [F. Caporale et al., Eur. Phys. J. C 74 (2014) 10, 3084]

(left figure) 🔗 [F. G. C., A. Papa, Phys. Rev. D 106 (2022) 11, 114004]

(right figure) 🔗 [F. G. C., Eur. Phys. J. C 81 (2021) 8, 691]

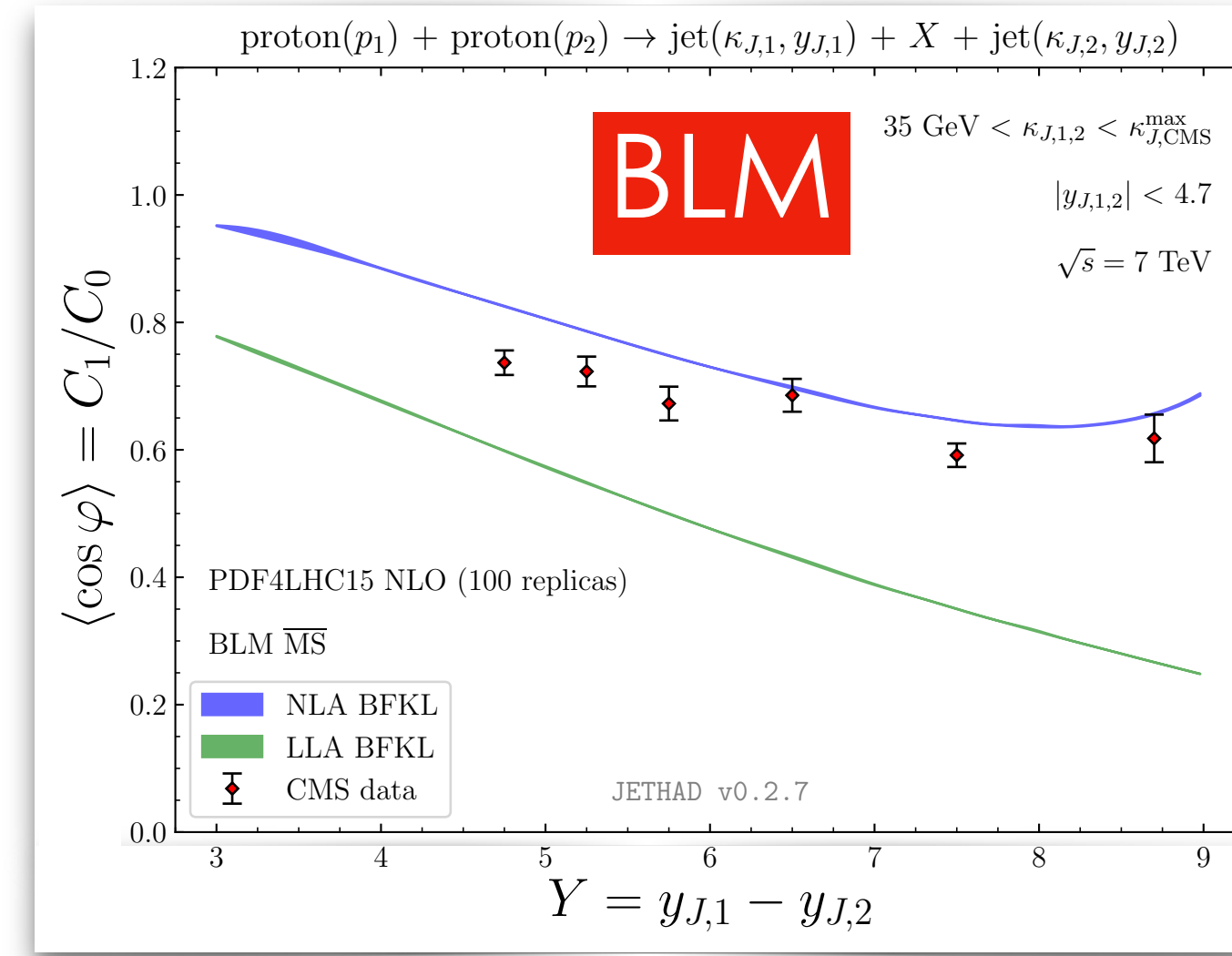
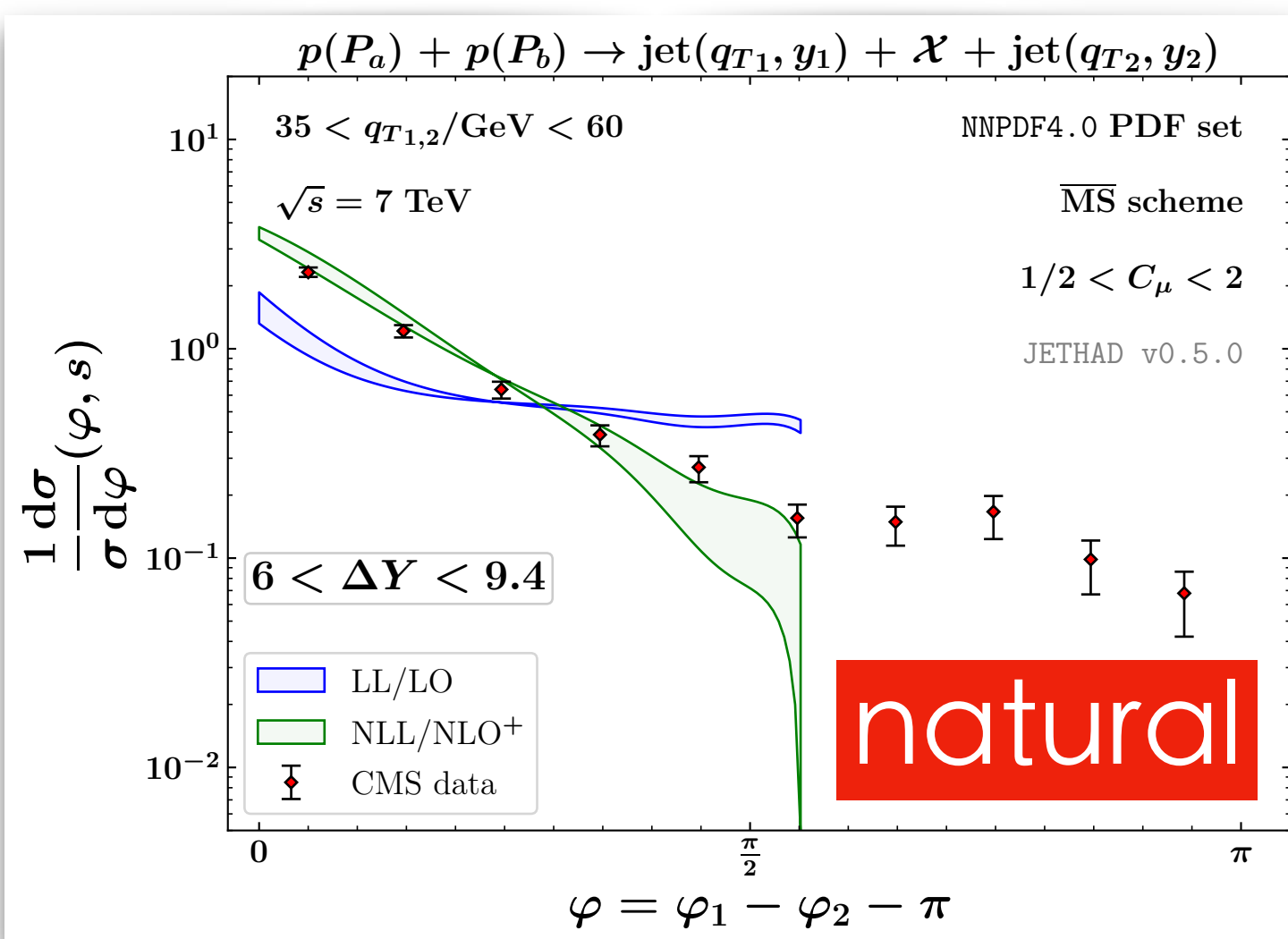

$\mu_R^{\text{BLM}} \gg \mu_R^{\text{nat.}} \Rightarrow d\sigma^{\text{BLM}}/d\sigma^{\text{nat.}} \sim 10^{-(1\div 2)} \Rightarrow$ precision studies hampered



Unsuccessful scale optimization \rightarrow processes featuring natural stability (🤔?)

Azimuthal-angle multiplicity

$$\frac{1}{\sigma} \frac{d\sigma(\Delta Y, s)}{d\varphi} = \frac{1}{2\pi} \left\{ 1 + 2 \sum_{n=1}^{\infty} \cos(n\varphi) \langle \cos(n\varphi) \rangle \right\}$$

MUELLER-NAVELET JETS

- [\[B. Ducloué, L. Szymanowski, S. Wallon, Phys. Rev. Lett. 112 \(2014\) 082003\]](#)
 (figure below) [\[F. G. C., A. Papa, Phys. Rev. D 106 \(2022\) 11, 114004\]](#)

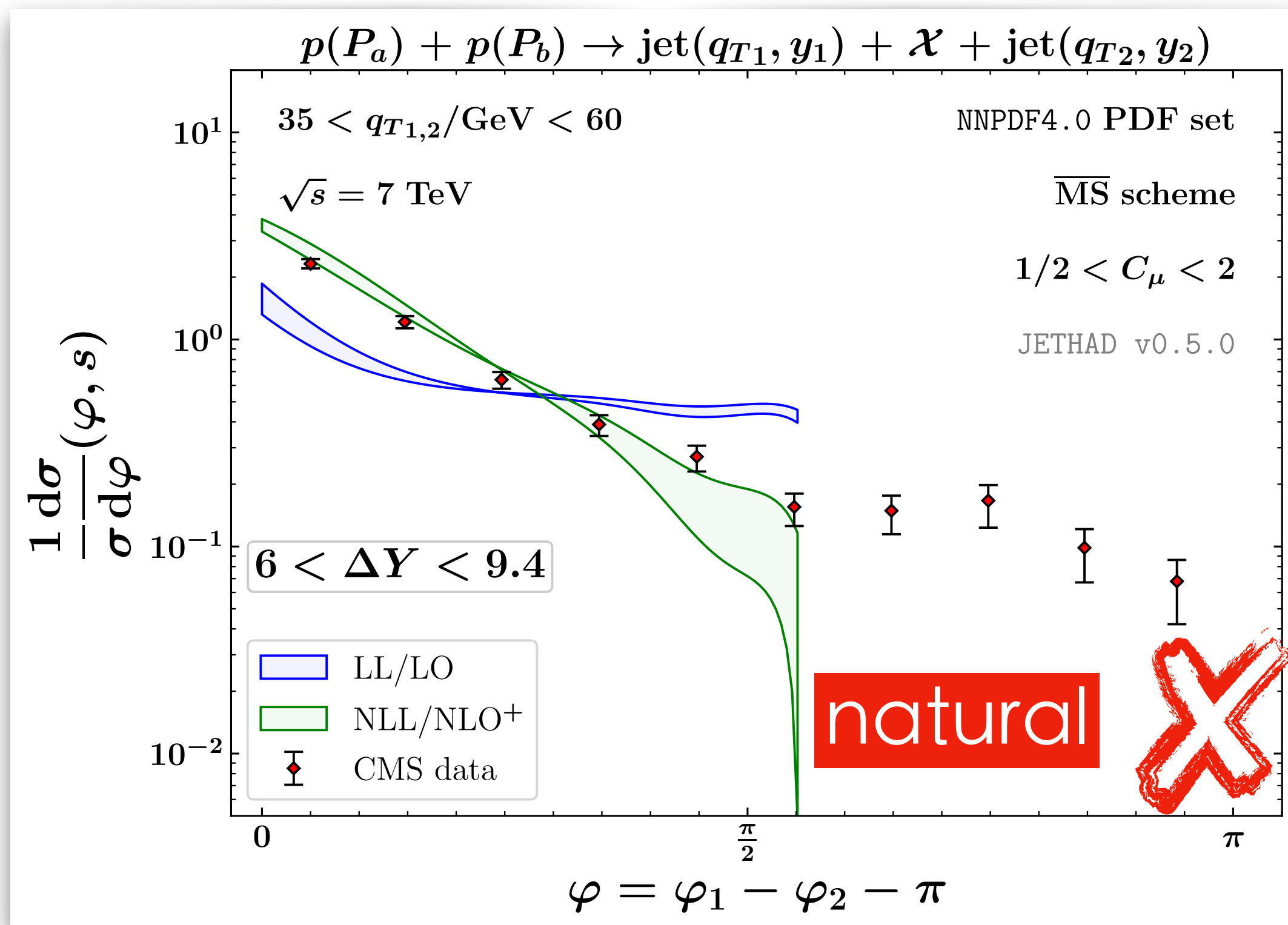

Azimuthal-angle multiplicity

$$\frac{1}{\sigma} \frac{d\sigma(\Delta Y, s)}{d\varphi} = \frac{1}{2\pi} \left\{ 1 + 2 \sum_{n=1}^{\infty} \cos(n\varphi) \langle \cos(n\varphi) \rangle \right\}$$

MUELLER-NAVELET JETS

HIGGS + JET

[\[B. Ducloué, L. Szymanowski, S. Wallon, Phys. Rev. Lett. 112 \(2014\) 082003\]](#)
 (figure below) [\[F. G. C., A. Papa, Phys. Rev. D 106 \(2022\) 11, 114004\]](#)

(figure below) [\[F. G. C. et al., Eur. Phys. J. C 81 \(2021\) 4, 293\]](#)
 (NLO Higgs coefficient function) [\[F. G. C. et al., JHEP 08 \(2022\) 092\]](#)

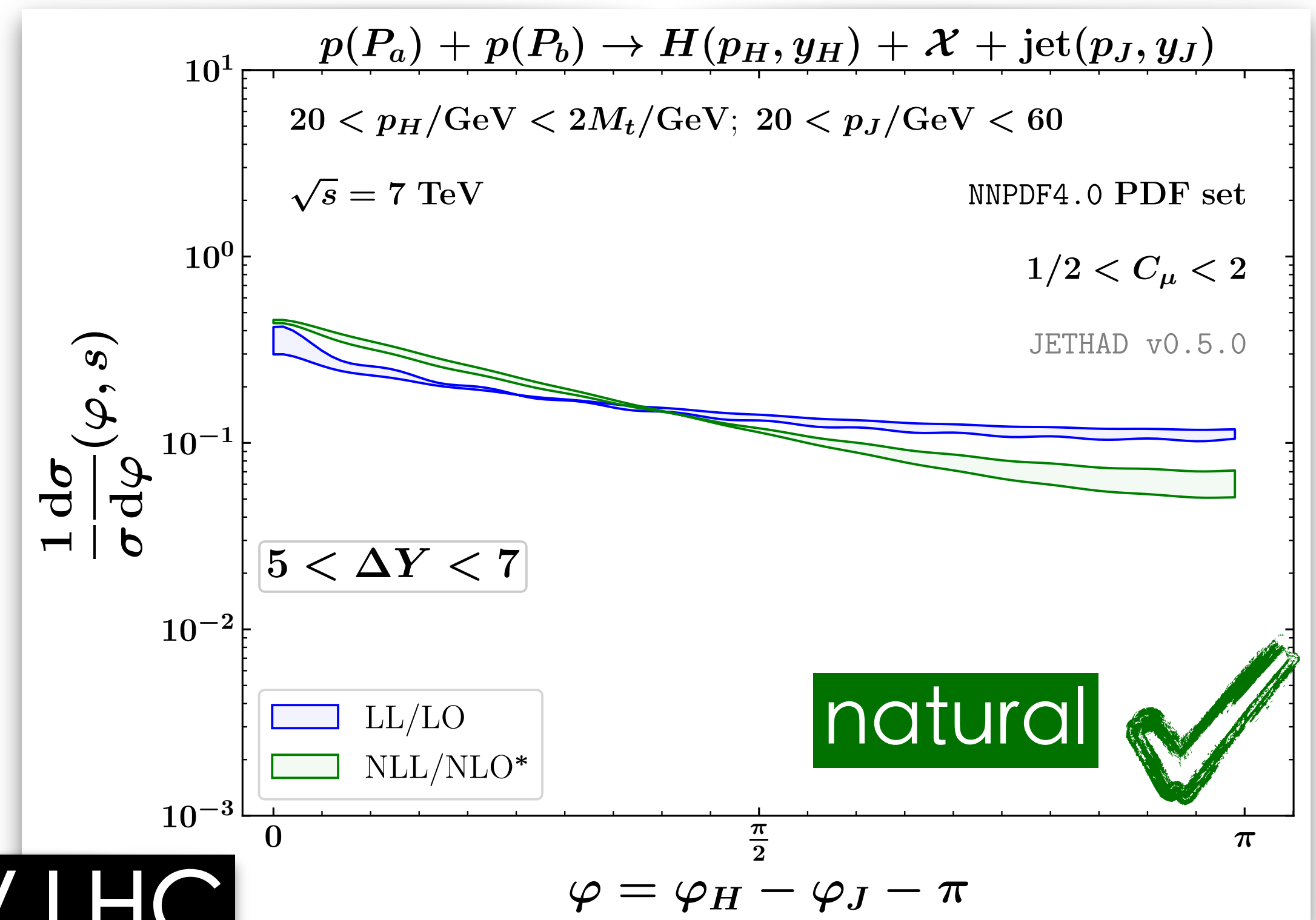
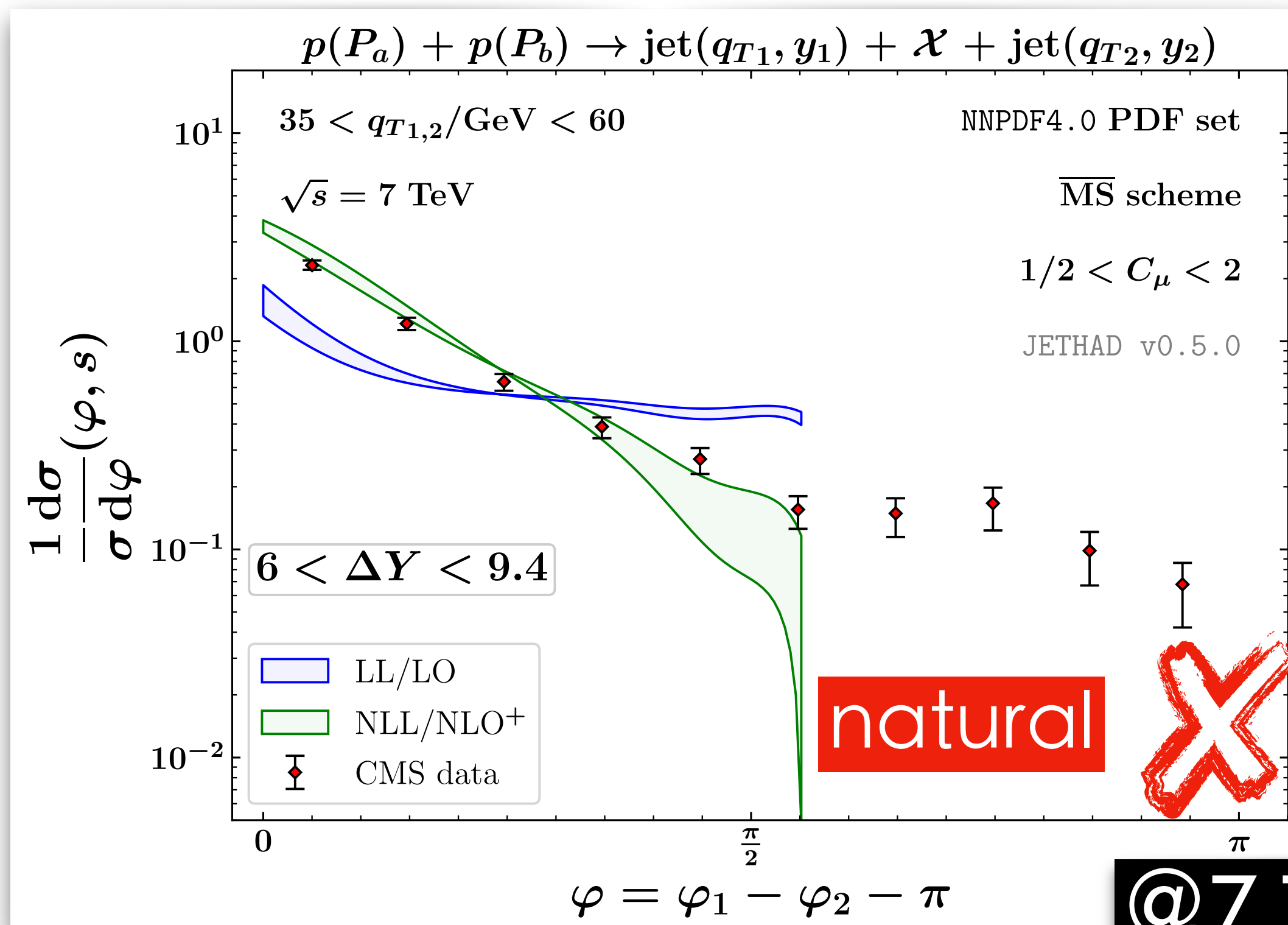

@7 TeV LHC

Backup



Hybrid factorization via the JETHAD code python

[\[F. G. C., Eur. Phys. J. C 81 \(2021\) 8, 691\].](#) [\[F. G. C., Phys. Rev. D 105 \(2022\) 11, 114008\]](#)

Higgs + jet highlights from the FCC Week 2022

The high-energy QCD dynamics from Higgs+jet correlations at FCC

Francesco G. Celiberto^{1,2,3} and Alessandro Papa^{4,5}

FCC Week 2022, Sorbonne Université, France

Hors d'œuvre

- Higgs sector → SM benchmarks, BSM portals
- Gluon fusion → key ingredient for precision QCD
- Fixed-order ← improved by resummations
- FCC energies ↔ high-energy (HE) resummation
- Higgs+jet → golden channel to hunt for HE signals

NLL/NLO differential cross section

$$\frac{d\sigma}{dy_1 dy_2 d^2k_1 d^2k_2} = \sum_{r,s=q,g} \int_0^1 dx_1 \int_0^1 dx_2 f_r(x_1, \mu_F) f_s(x_2, \mu_F) \frac{d\hat{\sigma}_{rs}(x_1, x_2, s, \mu_F)}{dy_1 dy_2 d^2k_1 d^2k_2}$$

$$\frac{d\hat{\sigma}_{rs}(x_1, x_2, s, \mu)}{dy_1 dy_2 d^2\vec{p}_{T1} d^2\vec{p}_{T2}} = \frac{1}{(2\pi)^2} \times \int \frac{d^2\vec{q}_1}{q_1^2} V_H^{(r)}(\vec{q}_1, s_0, x_1, \vec{p}_{T1}) \times \int_{s-i\infty}^{s+i\infty} \frac{d\omega}{2\pi i} \left(\frac{x_1 x_2 s}{s_0} \right)^\omega G_\omega(\vec{q}_1, \vec{q}_2) \times \int \frac{d^2\vec{q}_2}{q_2^2} V_J^{(s)}(\vec{q}_2, s_0, x_2, \vec{p}_{T2})$$

PDFs with threshold

NLO Higgs vertex

NLL BFKL kernel

NLO Jet vertex

Hybrid high-energy and collinear factorization at work

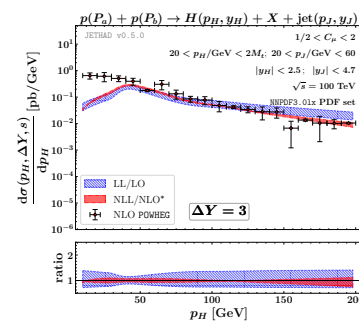

Higgs p_T distribution: NLL/NLO JETHAD vs NLO POWHEG

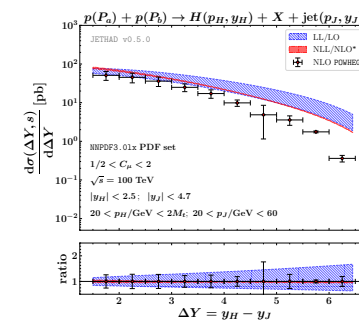

Rapidity distribution: NLL/NLO JETHAD vs NLO POWHEG

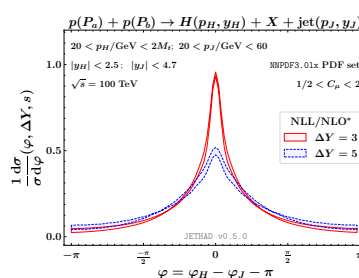

Azimuthal distribution at NLL/NLO

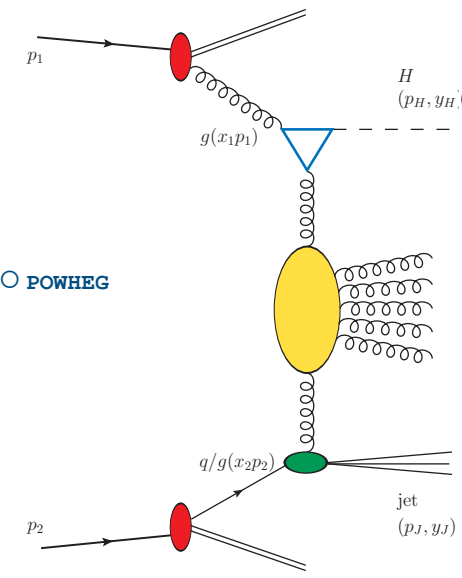

HE resummation from JETHAD

Large-x NNPDF3.0Lx PDFs with threshold

Comparison with fixed-order from POWHEG

Distributions stable under NLL corrections

A path towards precision

- ✓ NLL bands nested inside LL ones → solid stability
- ✓ HE signal clearly disengaged from NLO background
- ✓ Way toward precision studies of HE QCD (1!)
- Multilateral formalism → encode other resummations
- A window on proton structure at small-x (2?)

Further information

- ECT*, I-38123 Villazzano, Trento, Italy
- Fondazione Bruno Kessler (FBK), I-38123 Povo, Trento, Italy
- INFN-TIFPA, I-38123 Povo, Trento, Italy
- Università della Calabria, I-87036 Rende, Cosenza, Italy
- INFN-Cosenza, I-87036 Rende, Cosenza, Italy

Contact: fceliberto@ectstar.eu

Take a picture to the QR code to download the paper on Higgs+jet resummed distributions at 14TeV LHC: [FGC et al., EPJ C 81 (2021) 4, 293]

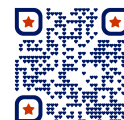

Higgs + jet highlights from the FCC Week 2022

The high-energy QCD dynamics from Higgs+jet correlations at FCC

Francesco G. Celiberto ^{1,2,3} and Alessandro Papa ^{4,5}

FCC Week 2022, Sorbonne Université, France

Hors d'œuvre

- Higgs sector → SM benchmarks, BSM portals
- Gluon fusion → key ingredient for precision QCD
- Fixed-order ← improved by resummations
- FCC energies ↔ high-energy (HE) resummation
- Higgs+jet → golden channel to hunt for HE signals

NLL/NLO differential cross section

$$\frac{d\sigma}{dy_1 dy_2 d^2\vec{k}_1 d^2\vec{k}_2} = \sum_{r,s=q,g} \int_0^1 dx_1 \int_0^1 dx_2 f_r(x_1, \mu_F) f_s(x_2, \mu_F) \frac{d\hat{\sigma}_{rs}(x_1, x_2, s, \mu_F)}{dy_1 dy_2 d^2\vec{k}_1 d^2\vec{k}_2}$$

$$\frac{d\hat{\sigma}_{rs}(x_1, x_2, s, \mu)}{dy_1 dy_2 d^2\vec{k}_1 d^2\vec{k}_2} = \frac{1}{(2\pi)^2} \times \int \frac{d^2\vec{q}_1}{q_1^2} V_H^{(r)}(\vec{q}_1, s_0, x_1, \vec{p}_H) \times \int_{s_0 - i\infty}^{s_0 + i\infty} \frac{d\omega}{2\pi i} \left(\frac{x_1 x_2 s}{s_0} \right)^\omega G_\omega(\vec{q}_1, \vec{q}_2) \times \int \frac{d^2\vec{q}_2}{q_2^2} V_J^{(s)}(\vec{q}_2, s_0, x_2, \vec{p}_J)$$

PDFs with threshold

NLO Higgs vertex

NLL BFKL kernel

NLO Jet vertex

$$C_n(\Delta Y, s) = \int_{p_H^{\min}}^{p_H^{\max}} d|\vec{p}_H| \int_{p_J^{\min}}^{p_J^{\max}} d|\vec{p}_J| \int_{y_H^{\min}}^{y_H^{\max}} dy_H \int_{y_J^{\min}}^{y_J^{\max}} dy_J \delta(y_H - y_J - \Delta Y) C_n$$

Rapidity distribution: NLL/NLO* JETHAD vs NLO POWHEG

Hybrid high-energy and collinear factorization at work

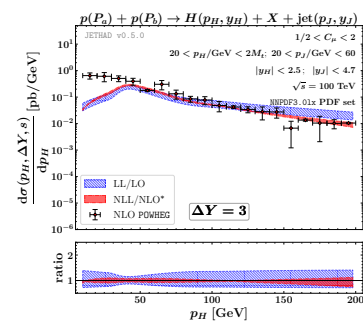

Higgs p_T distribution: NLL/NLO JETHAD vs NLO POWHEG

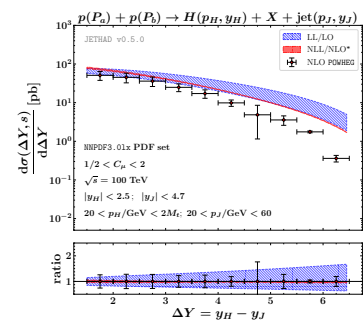

Rapidity distribution: NLL/NLO JETHAD vs NLO POWHEG

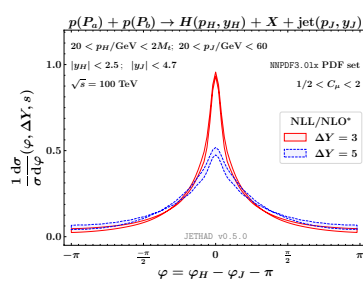

Azimuthal distribution at NLL/NLO

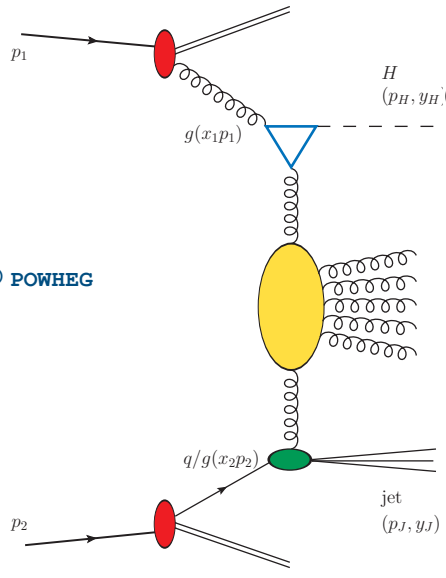

HE resummation from JETHAD

- Large-x NNPDF3.01x PDFs with threshold
- Comparison with fixed-order from POWHEG
- Distributions stable under NLL corrections

A path towards precision

- ✓ NLL bands nested inside LL ones → solid stability
- ✓ HE signal clearly disengaged from NLO background
- ✓ Way toward precision studies of HE QCD (1!)
- Multilateral formalism → encode other resummations
- A window on proton structure at small-x (2?)

Further information

- ECT*, I-38123 Villazzano, Trento, Italy
- Fondazione Bruno Kessler (FBK), I-38123 Povo, Trento, Italy
- INFN-TIFPA, I-38123 Povo, Trento, Italy
- Università della Calabria, I-87036 Rende, Cosenza, Italy
- INFN-Cosenza, I-87036 Rende, Cosenza, Italy

Contact: fceliberto@ectstar.eu

Take a picture to the QR code to download the paper on Higgs+jet resummed distributions at 14TeV LHC: [FGC et al., EPJ C 81 (2021) 4, 293]

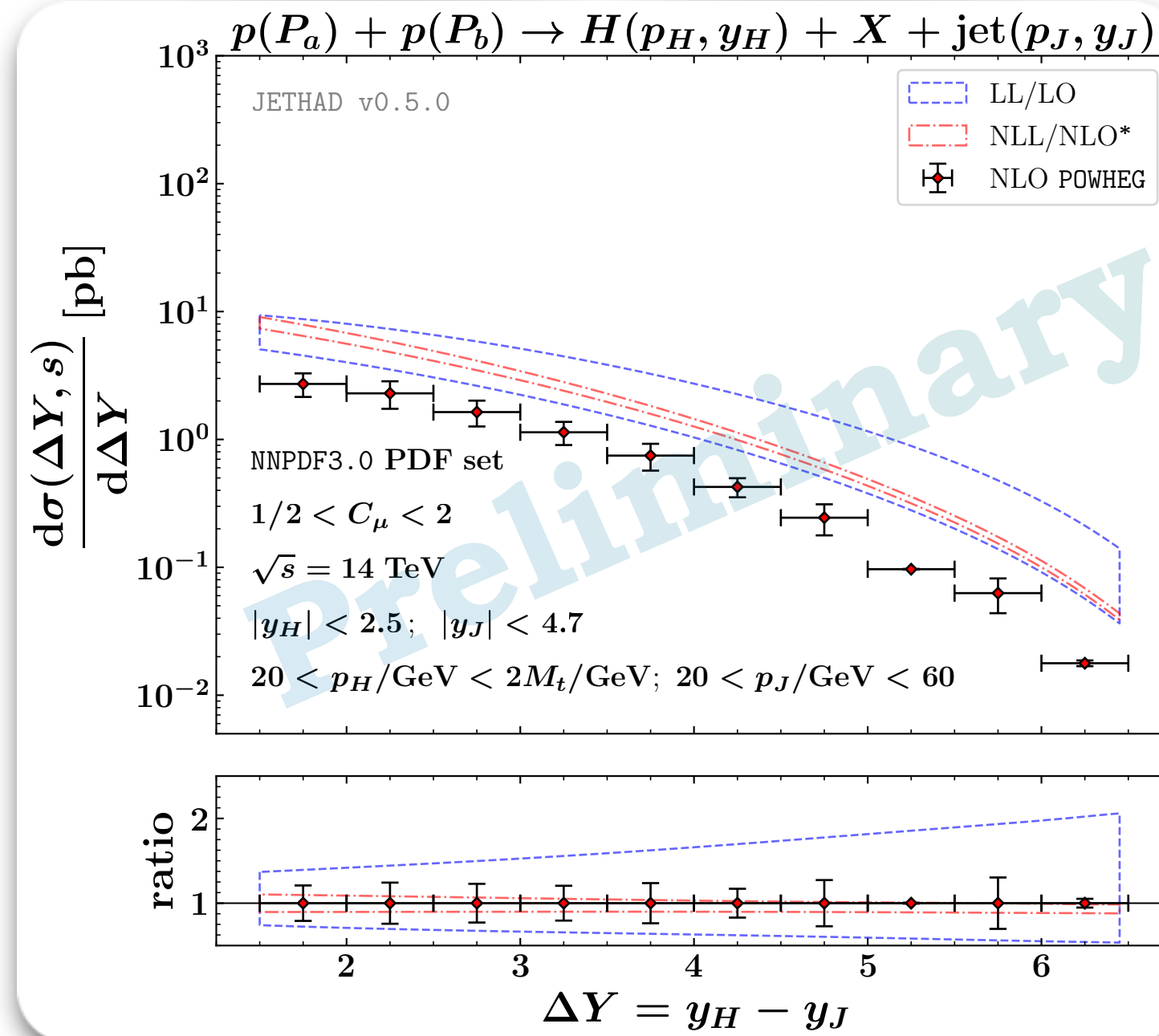
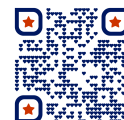

14 TeV LHC

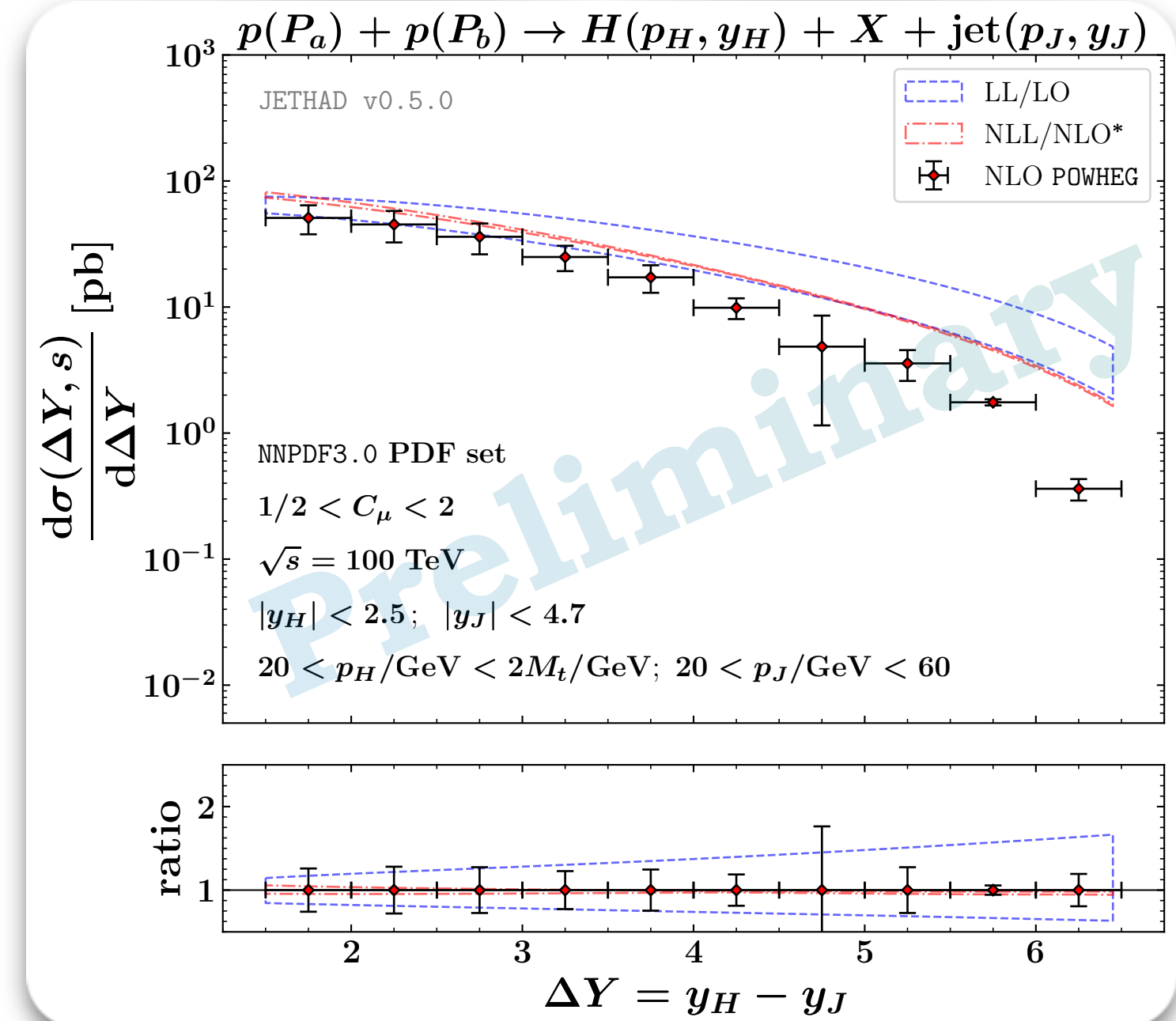

100 TeV FCC

Backup



Anatomy of Higgs + jet in hybrid factorization (HyF)

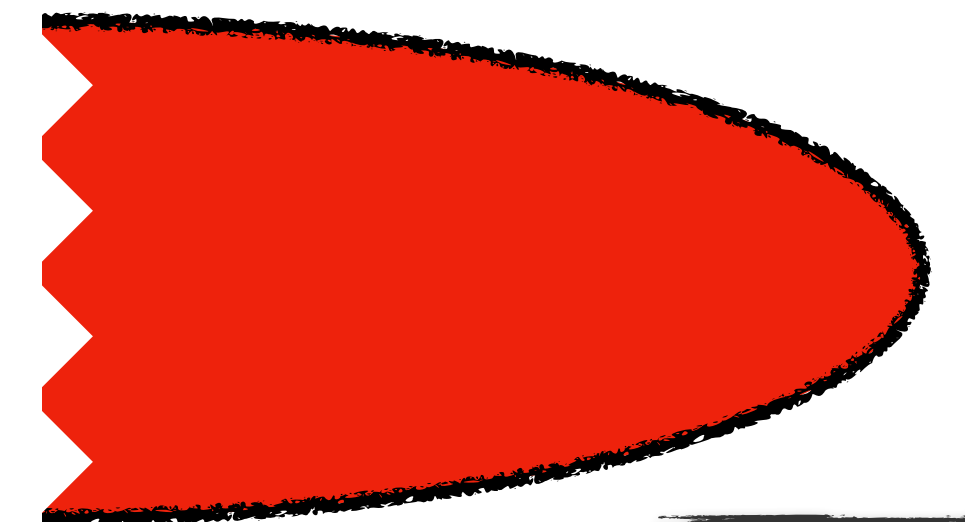
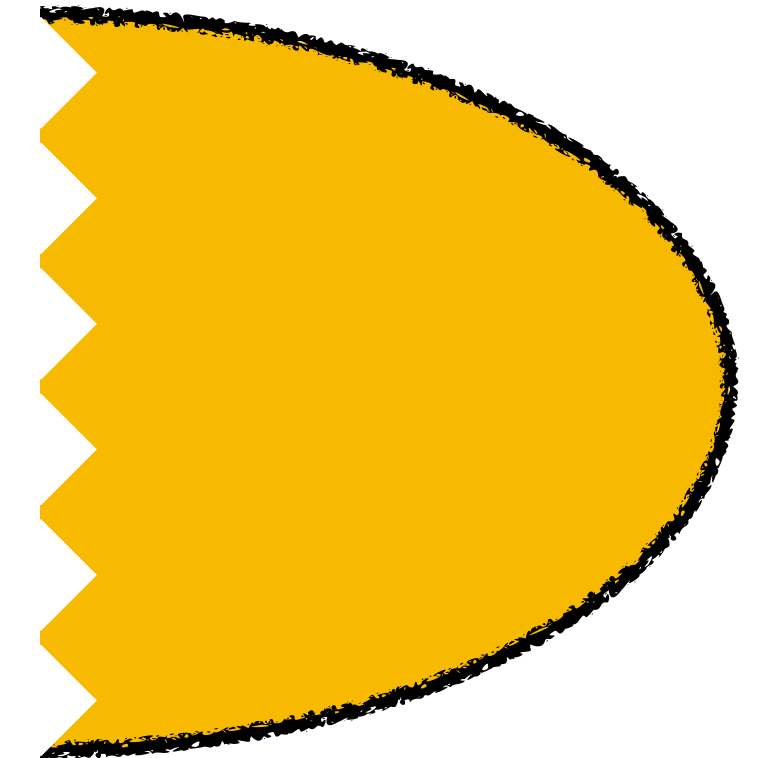
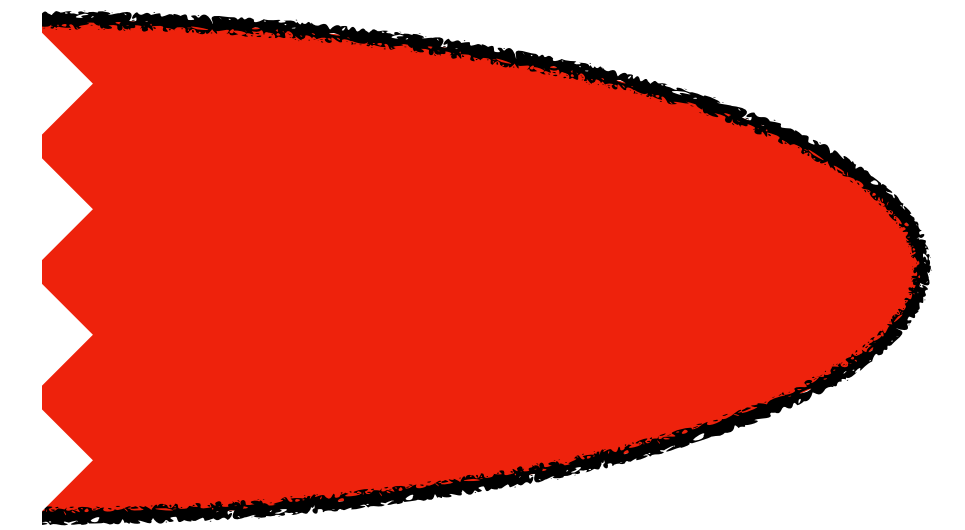
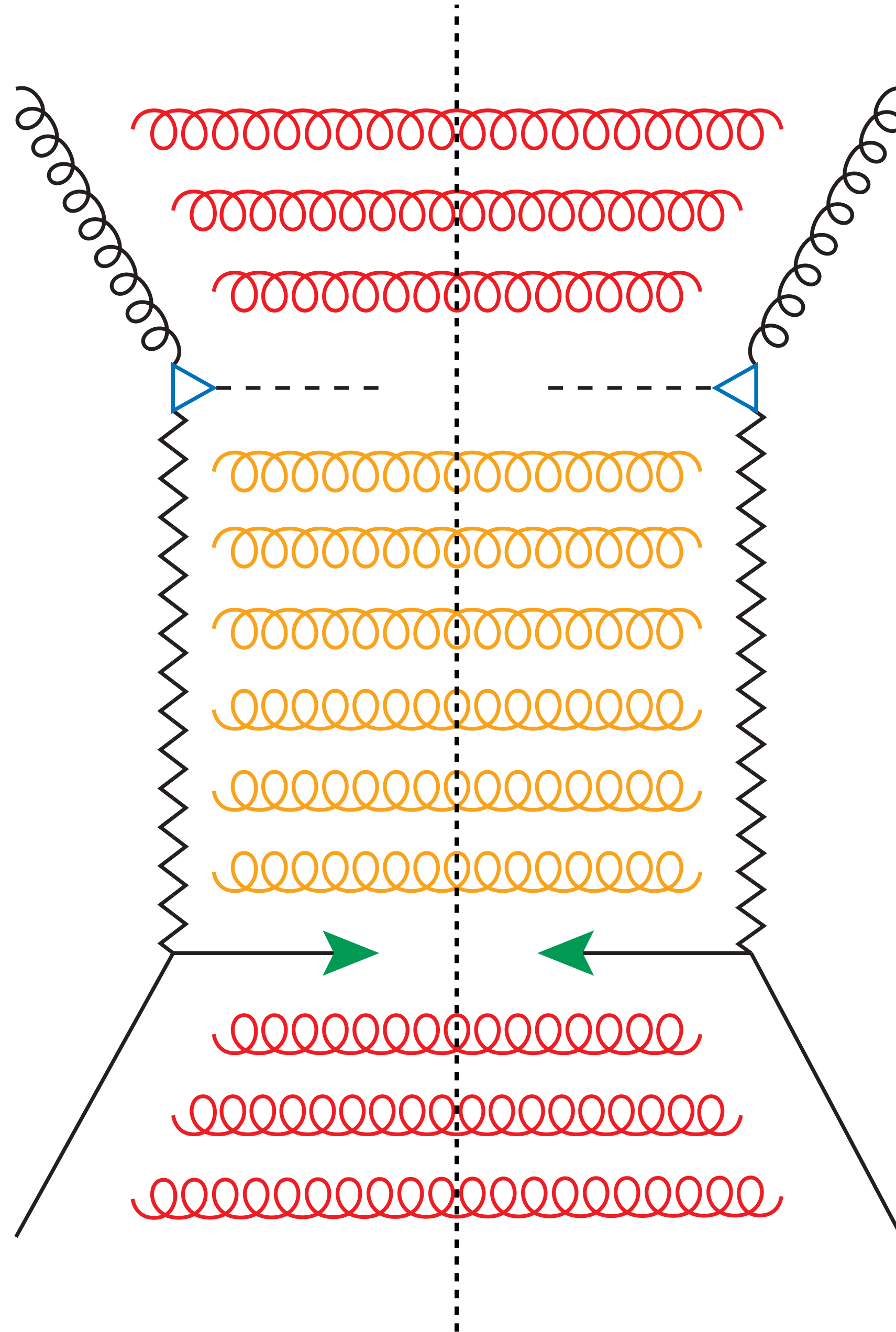
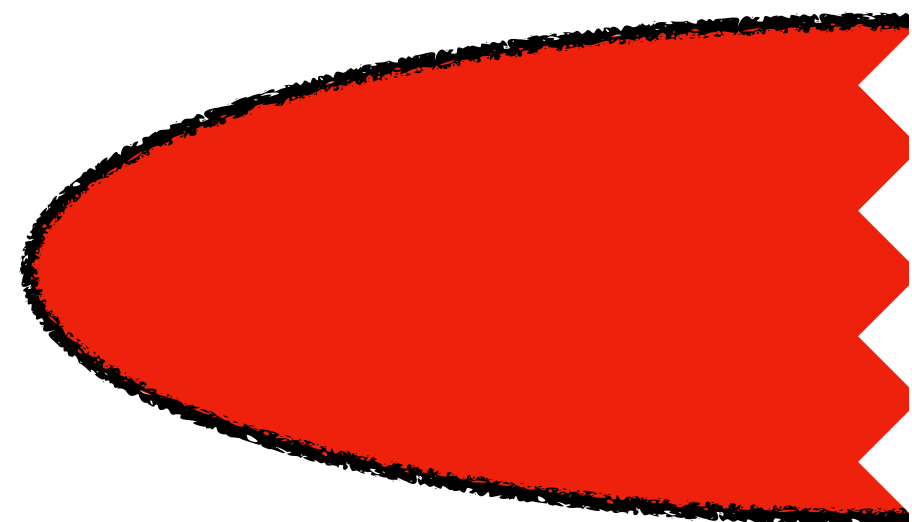
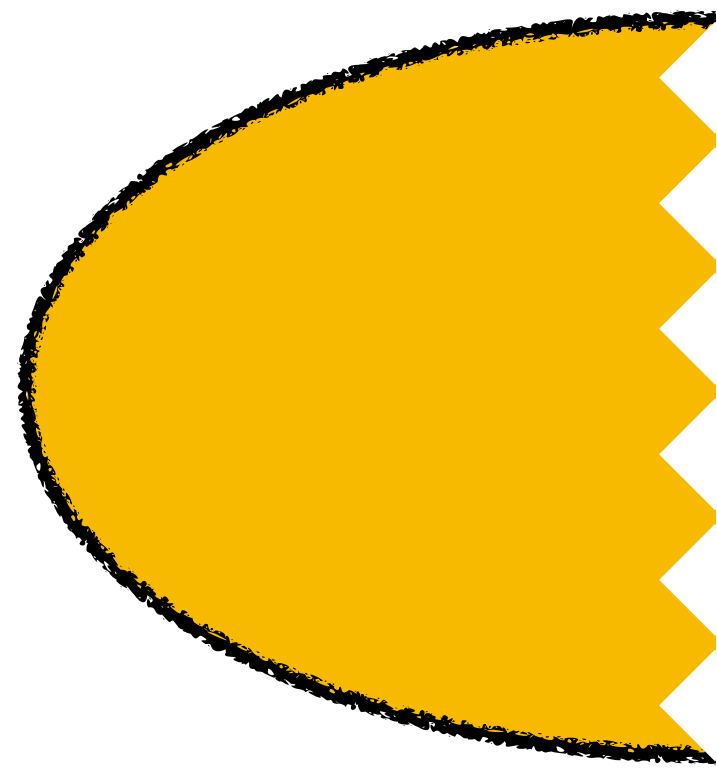
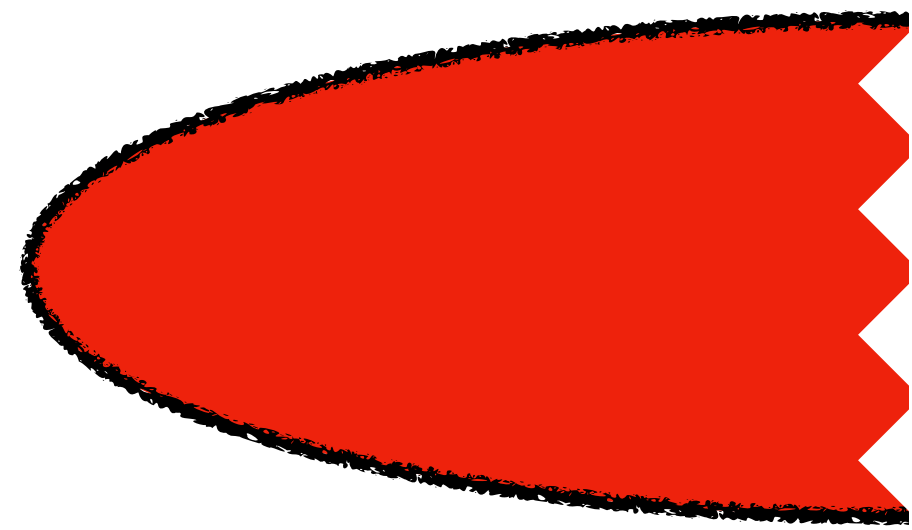

Anatomy of Higgs + jet in hybrid factorization (HyF)

FORWARD REGION

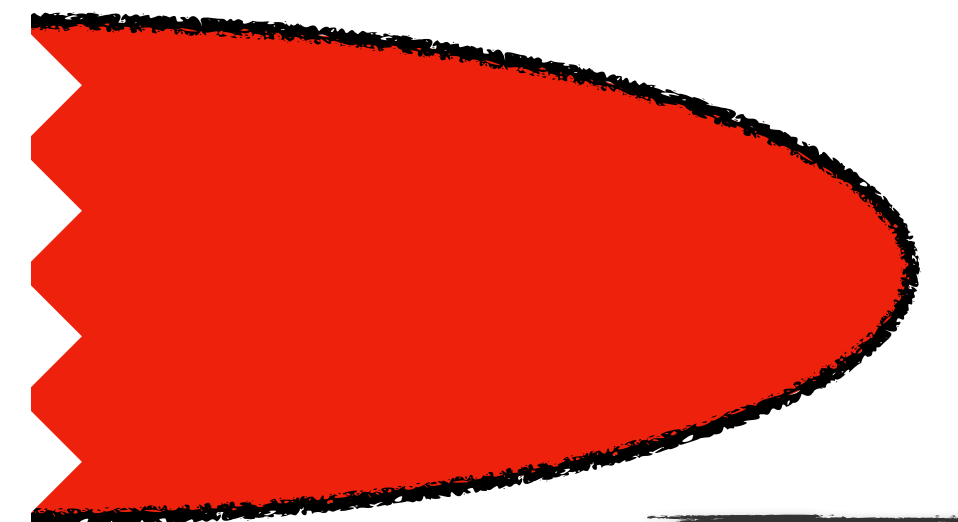
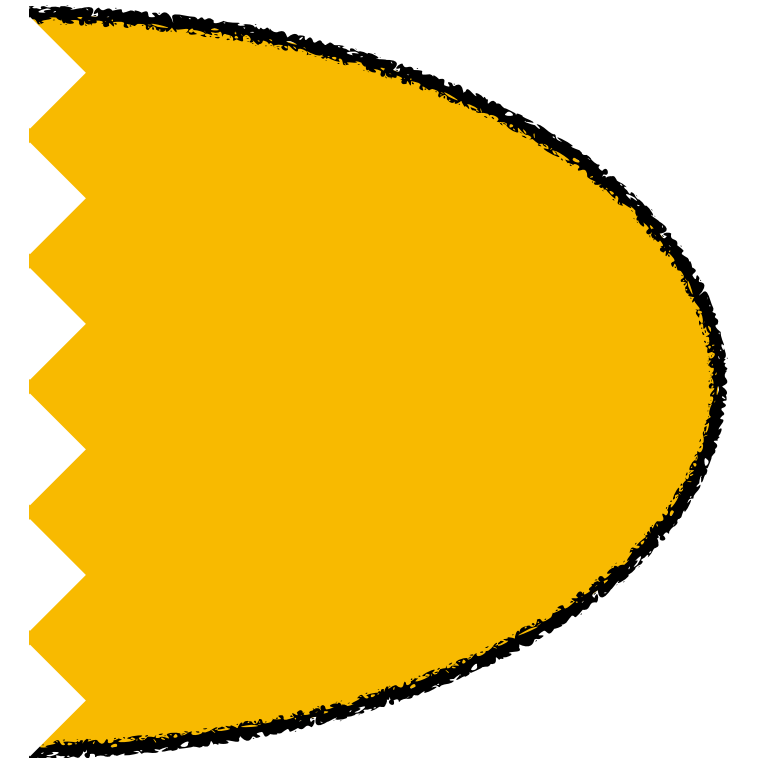
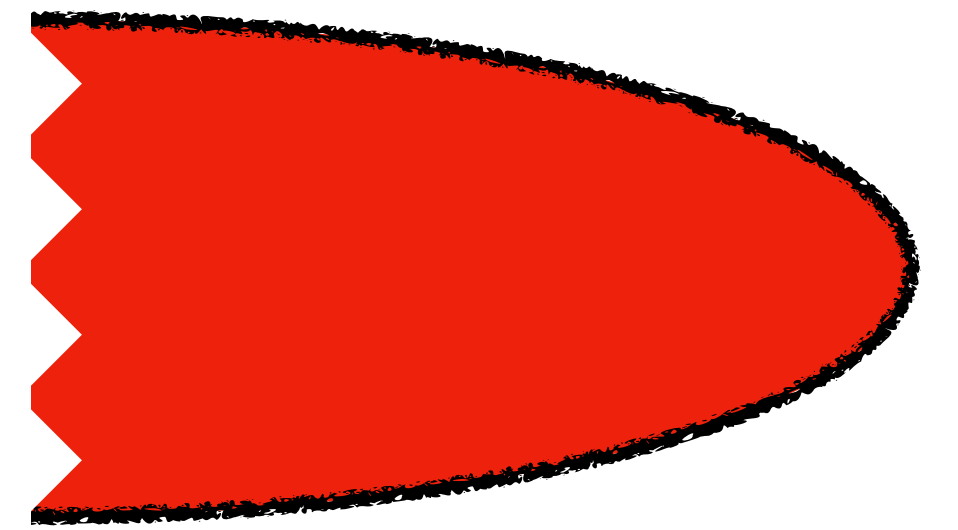
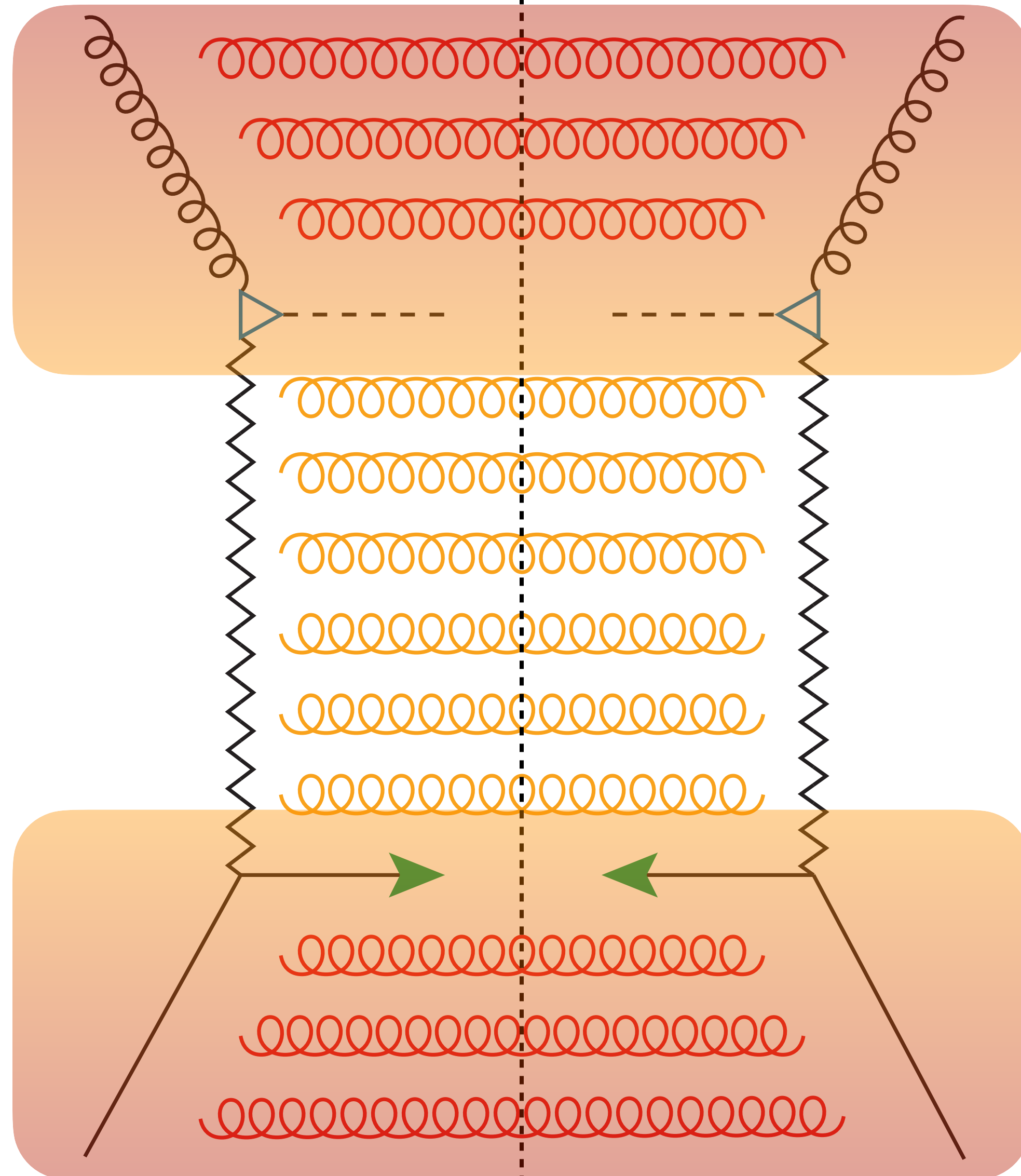
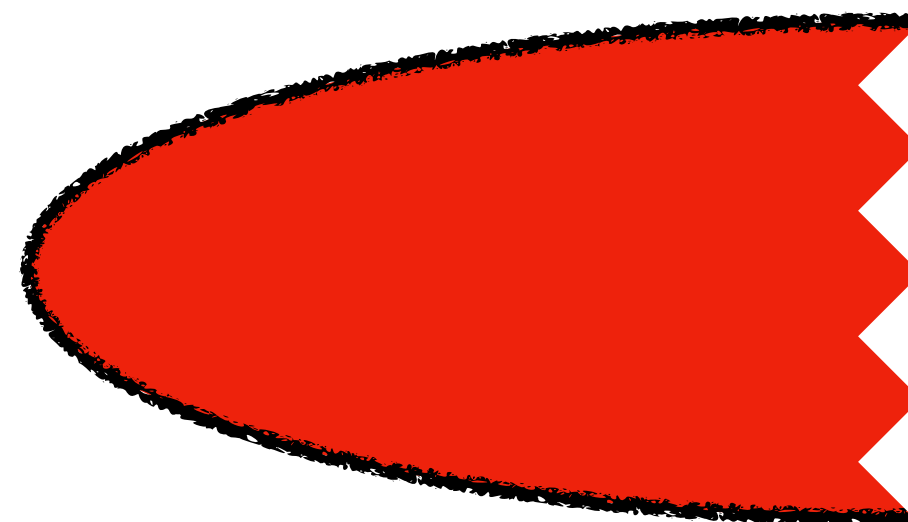
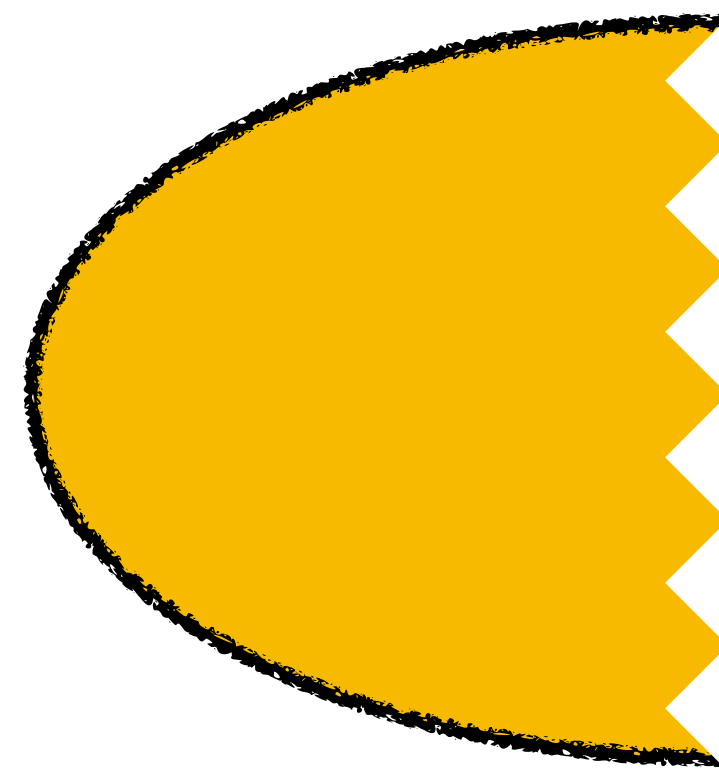
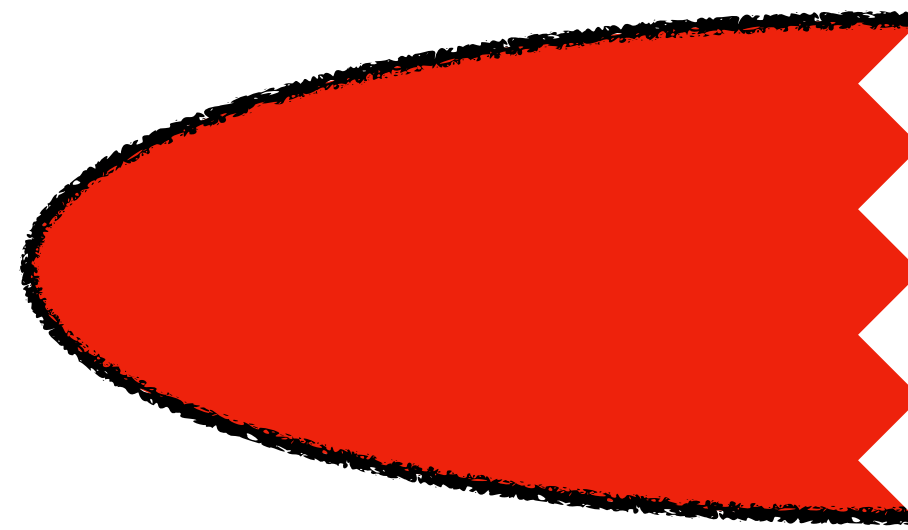

FORWARD REGION

Anatomy of Higgs + jet in hybrid factorization (HyF)

FORWARD REGION

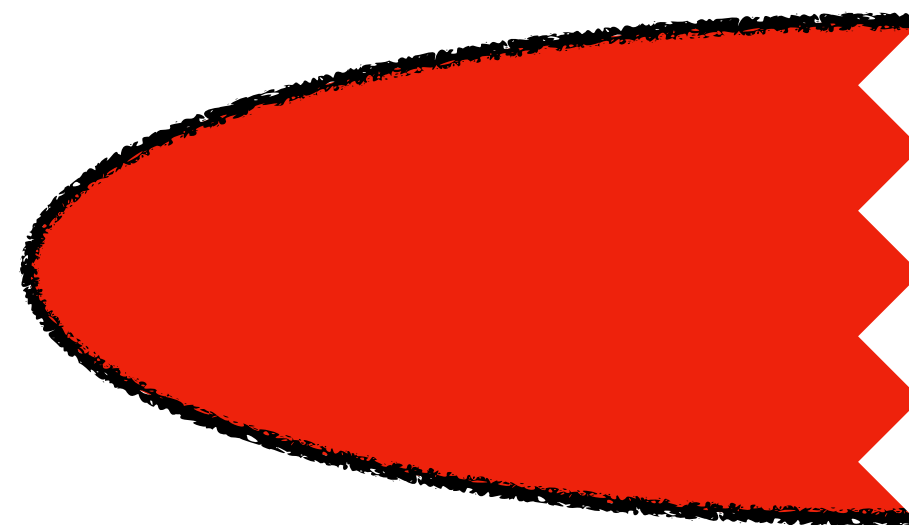
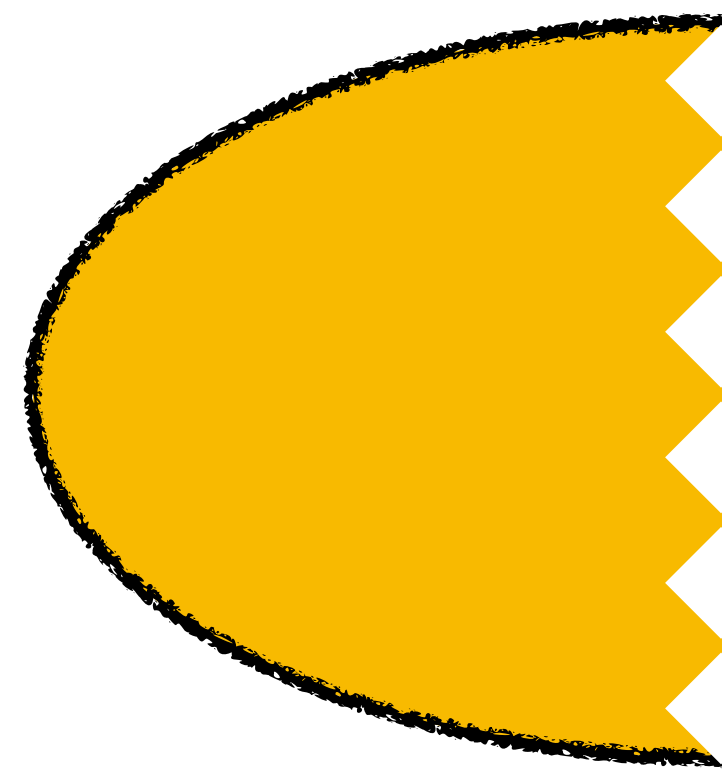
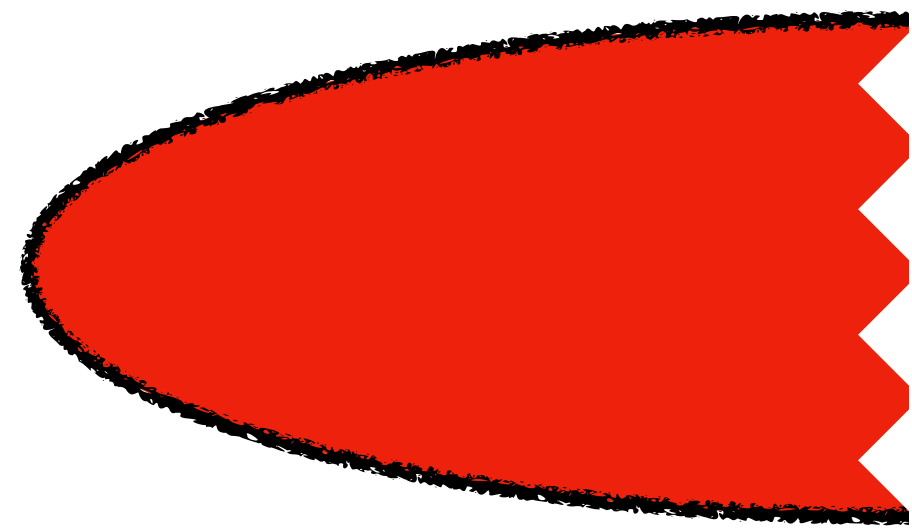

BFKL

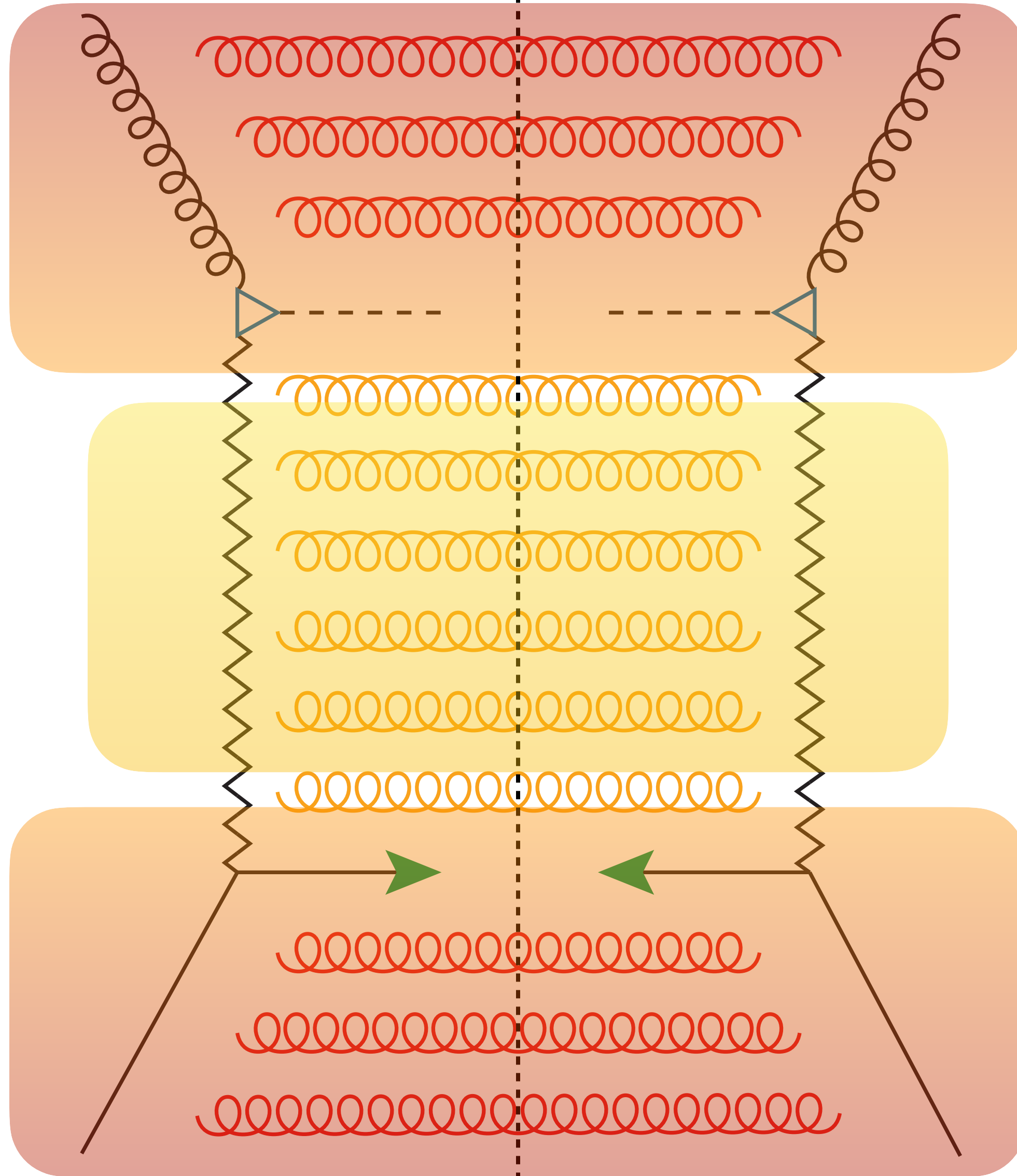

BFKL

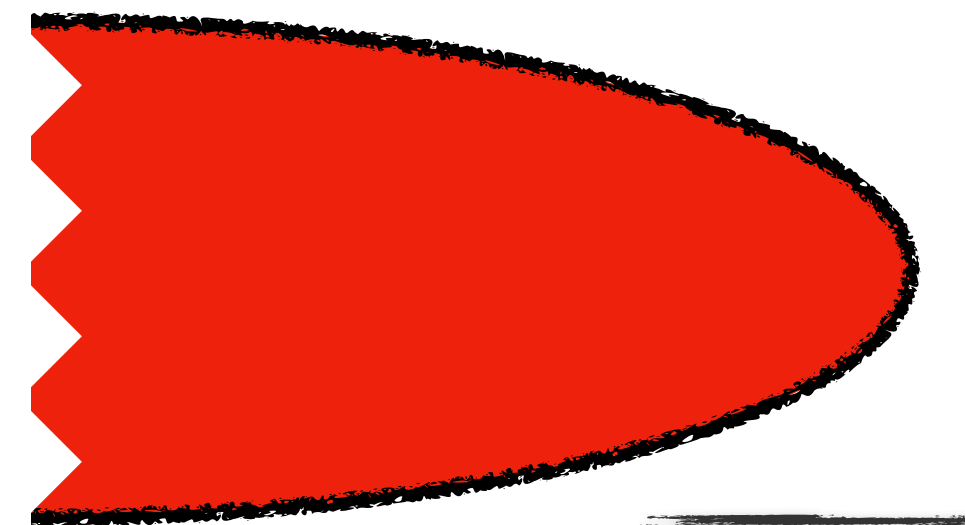
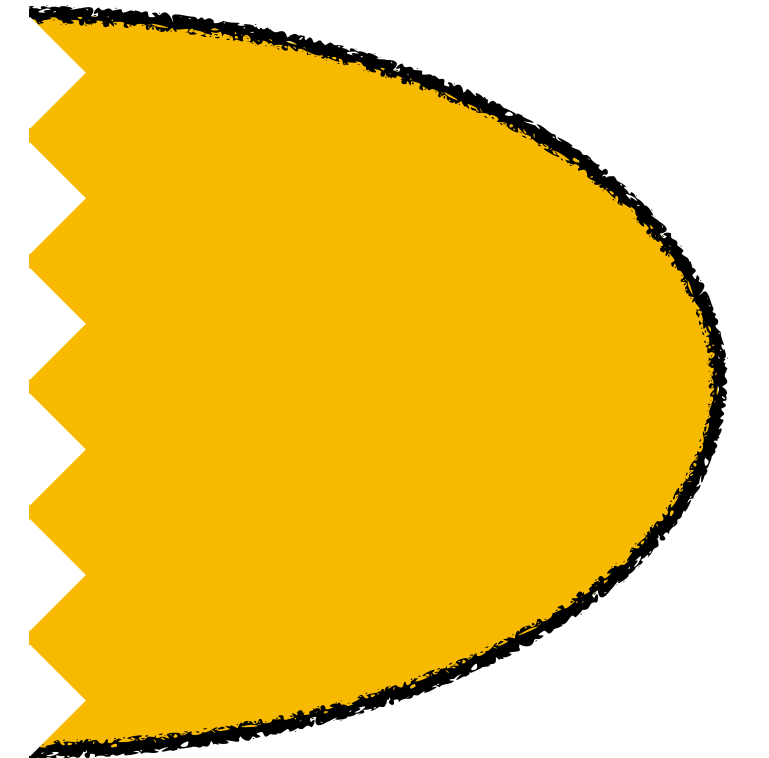
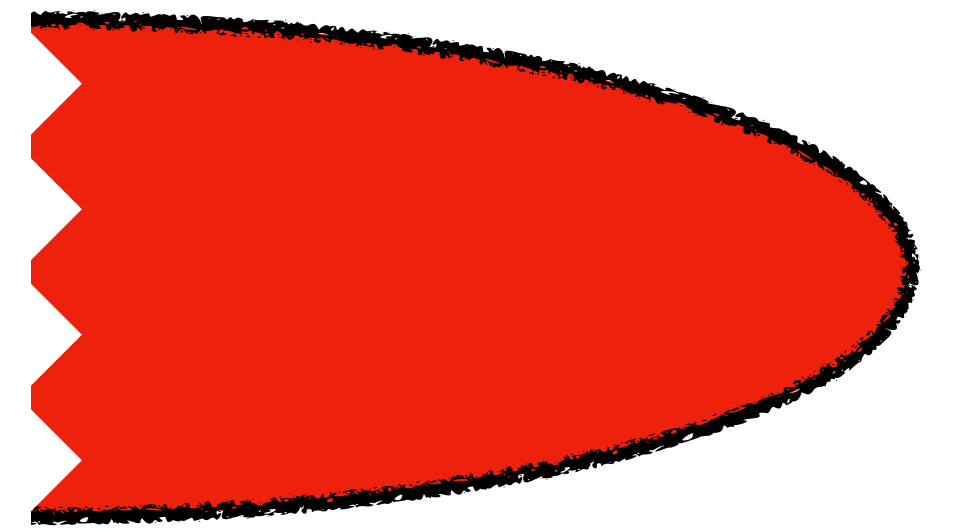

FORWARD REGION

Backup

Anatomy of Higgs + jet in hybrid factorization (HyF)

FORWARD REGION

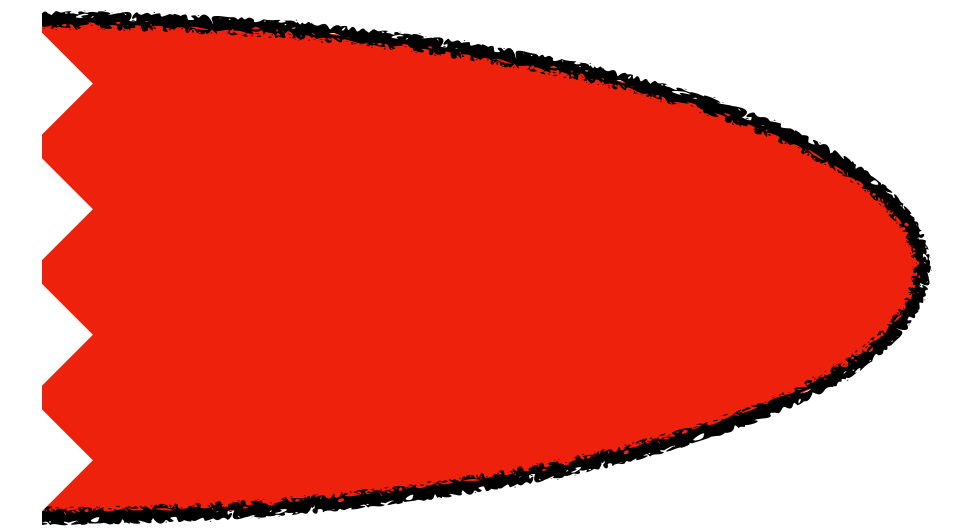
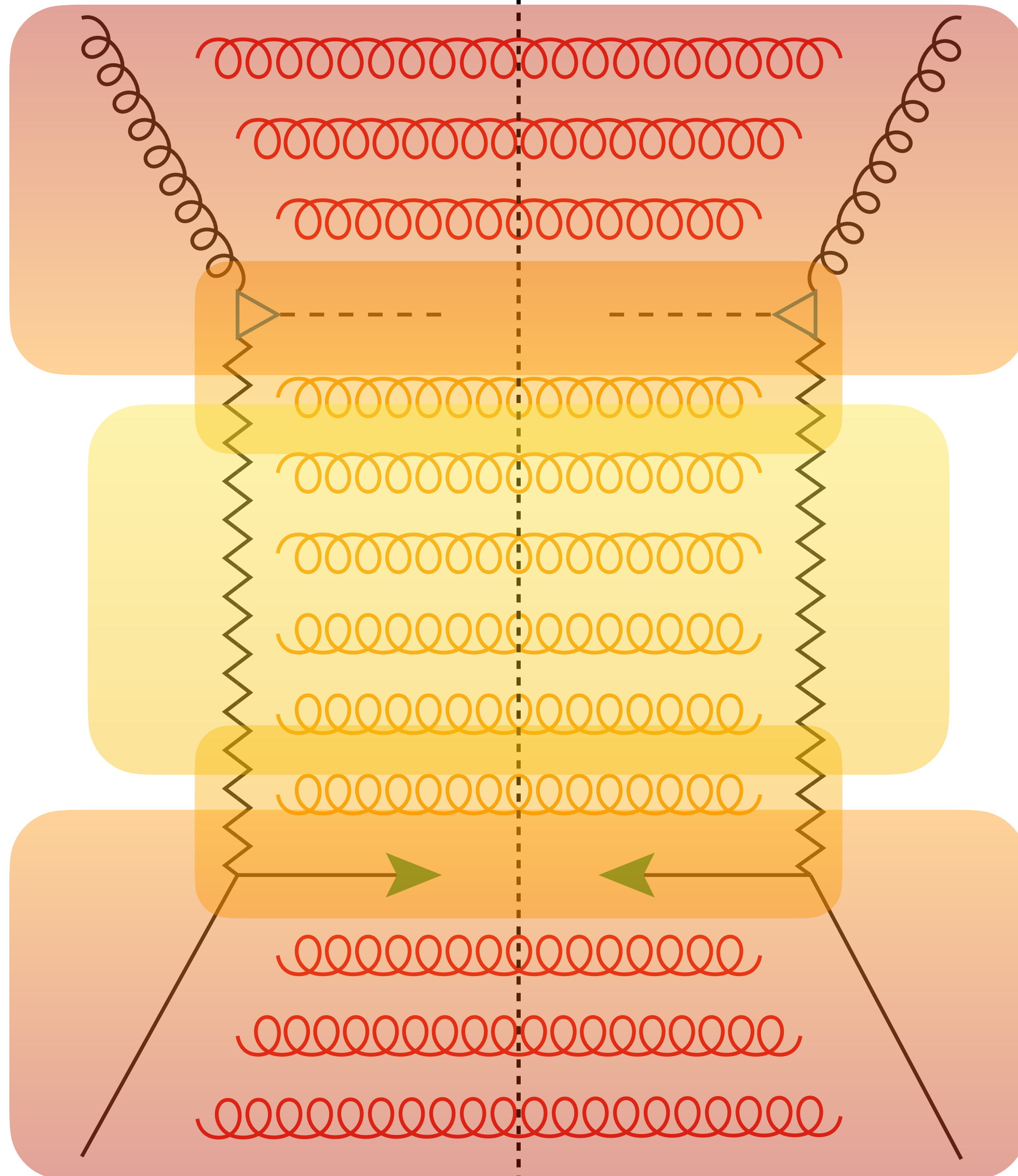
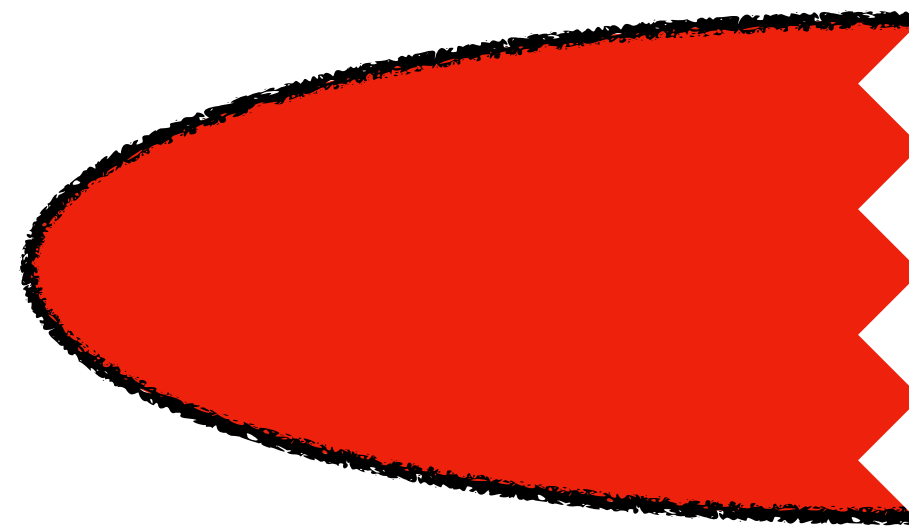

NEXT-TO-FORWARD REGION

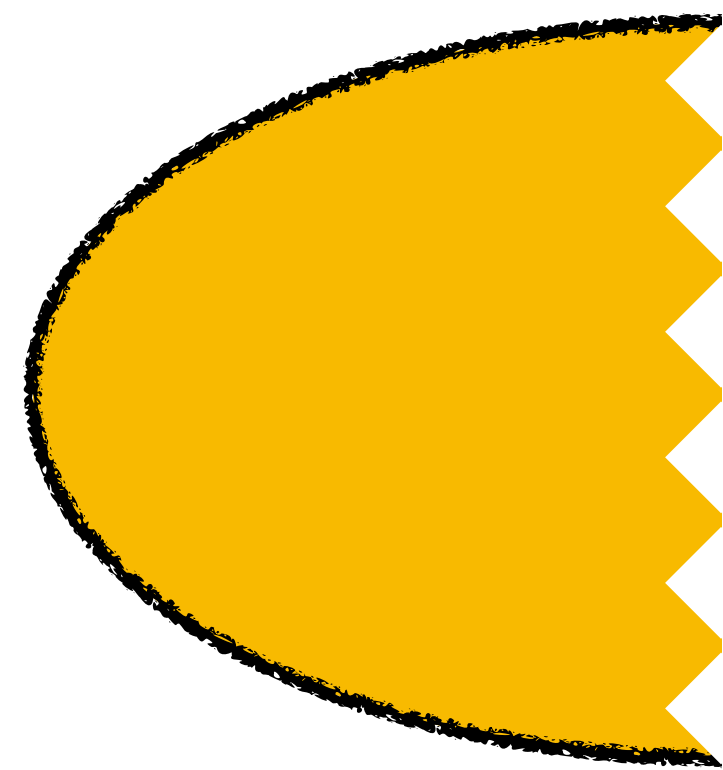

BFKL

BFKL

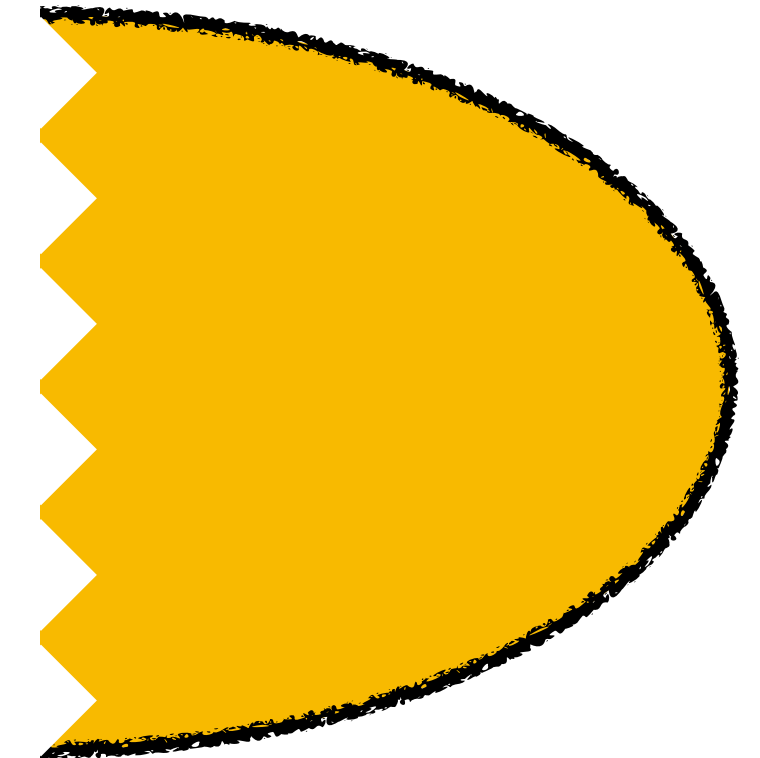

NEXT-TO-FORWARD REGION

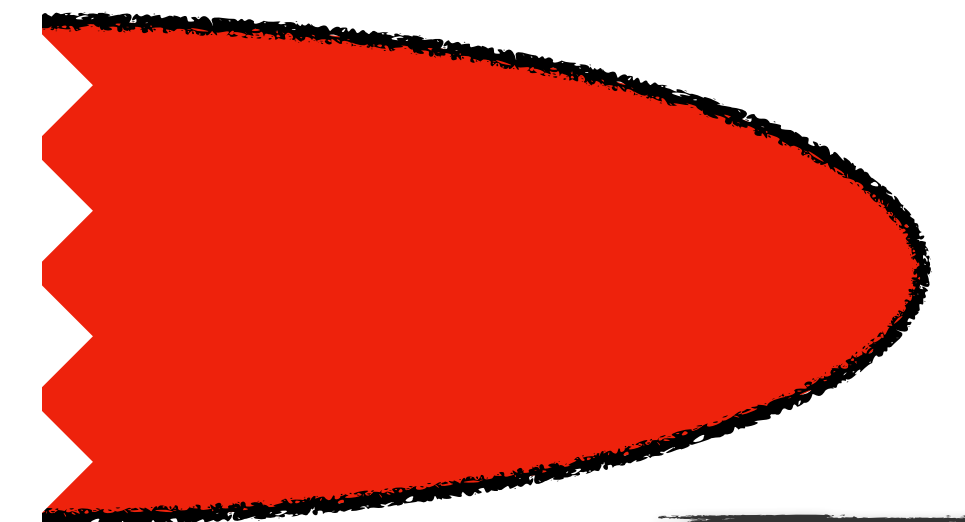
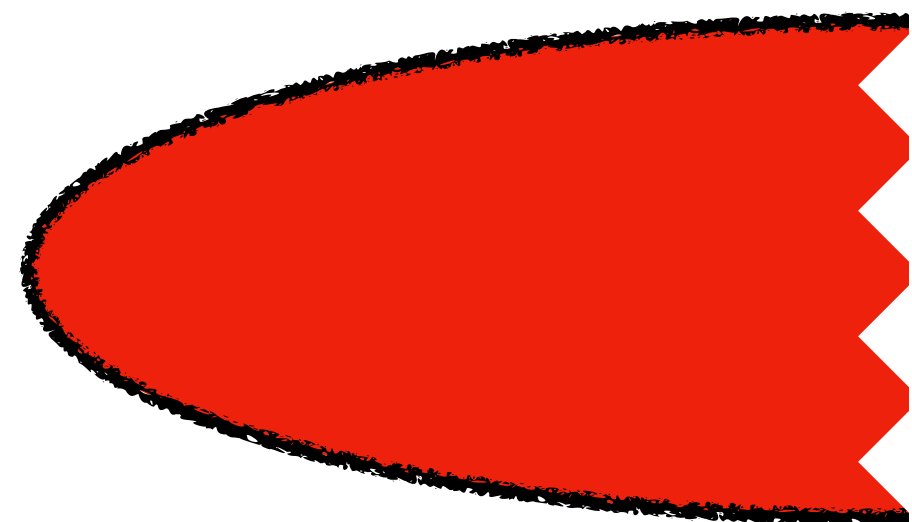

FORWARD REGION

The background of the slide features several overlapping, semi-transparent diagrams of particle interactions. These diagrams use various colored lines (yellow, blue, green, red) and arrows to represent different types of particles and their interactions, typical of Feynman diagrams. The overall aesthetic is scientific and technical, with a light blue and white color palette.

Ultraforward
charm + Higgs production
@14 TeV FPF+ATLAS

High-energy QCD at new-gen Forward Facilities

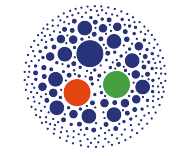

Forward + backward CMS detections: Mueller-Navelet, hadron-jet, di-hadron

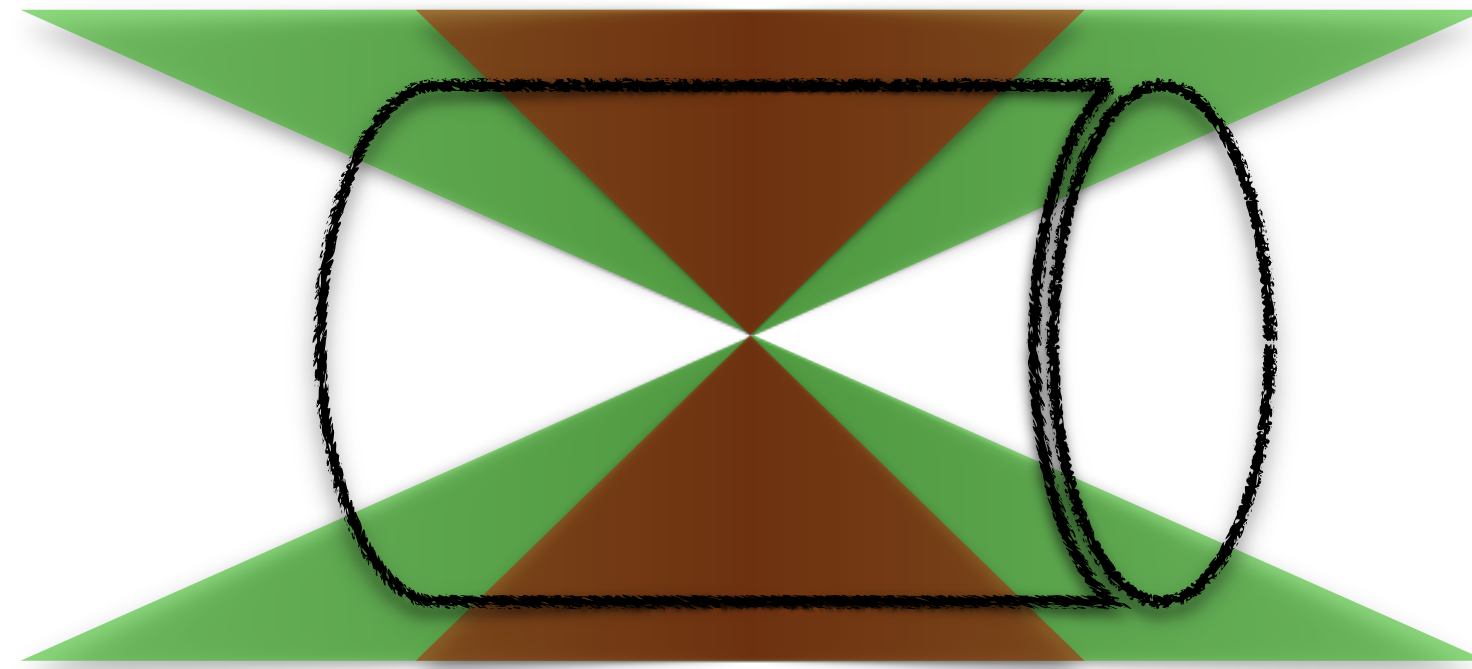

$$|y_{\text{jet}}| < 4.7$$

barrel + endcap

$$|y_{\text{hadron}}| < 2.4$$

barrel

High-energy QCD at new-gen Forward Facilities

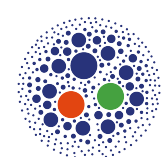

Forward + backward CMS detections: Mueller-Navelet, hadron-jet, di-hadron

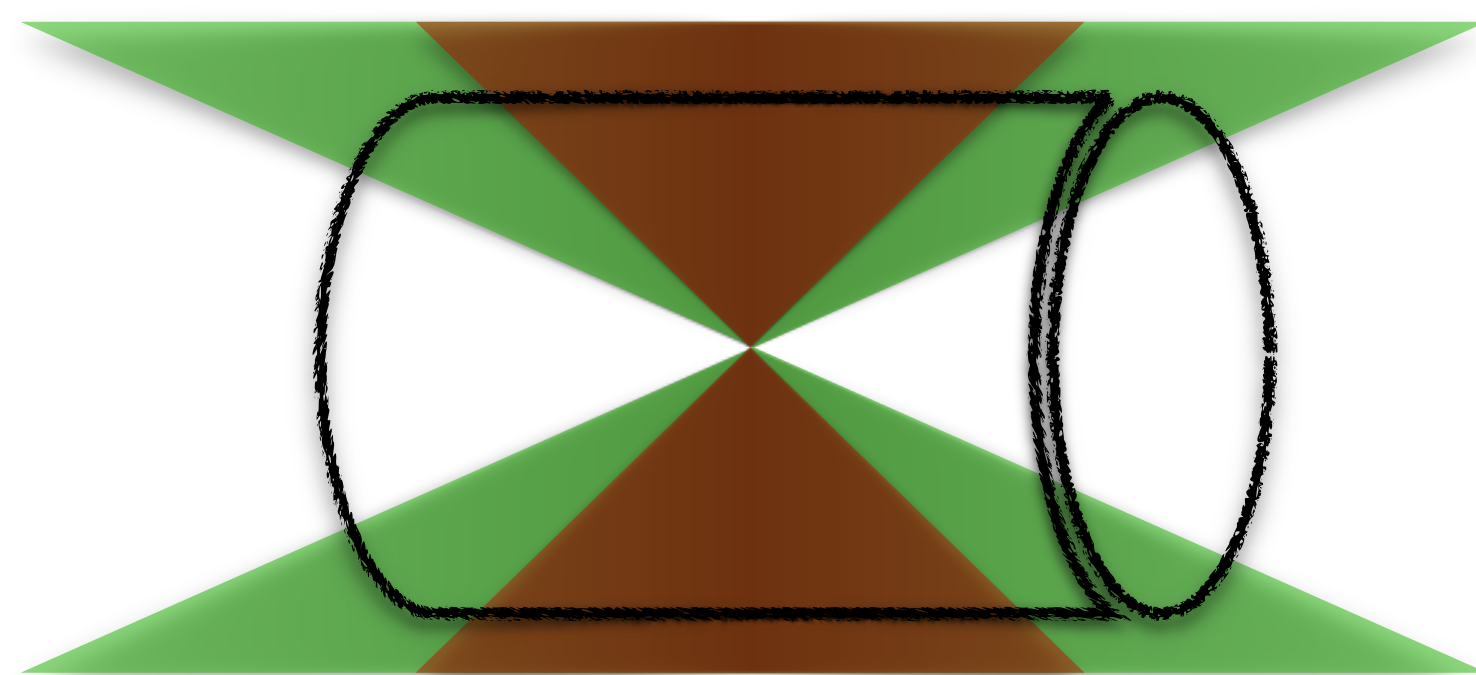

$$|y_{\text{jet}}| < 4.7$$

barrel + endcap

$$|y_{\text{hadron}}| < 2.4$$

barrel

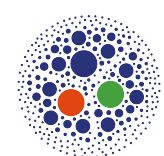

Ultra-forward FPF + central ATLAS detections: single-charmed hadrons + Higgs

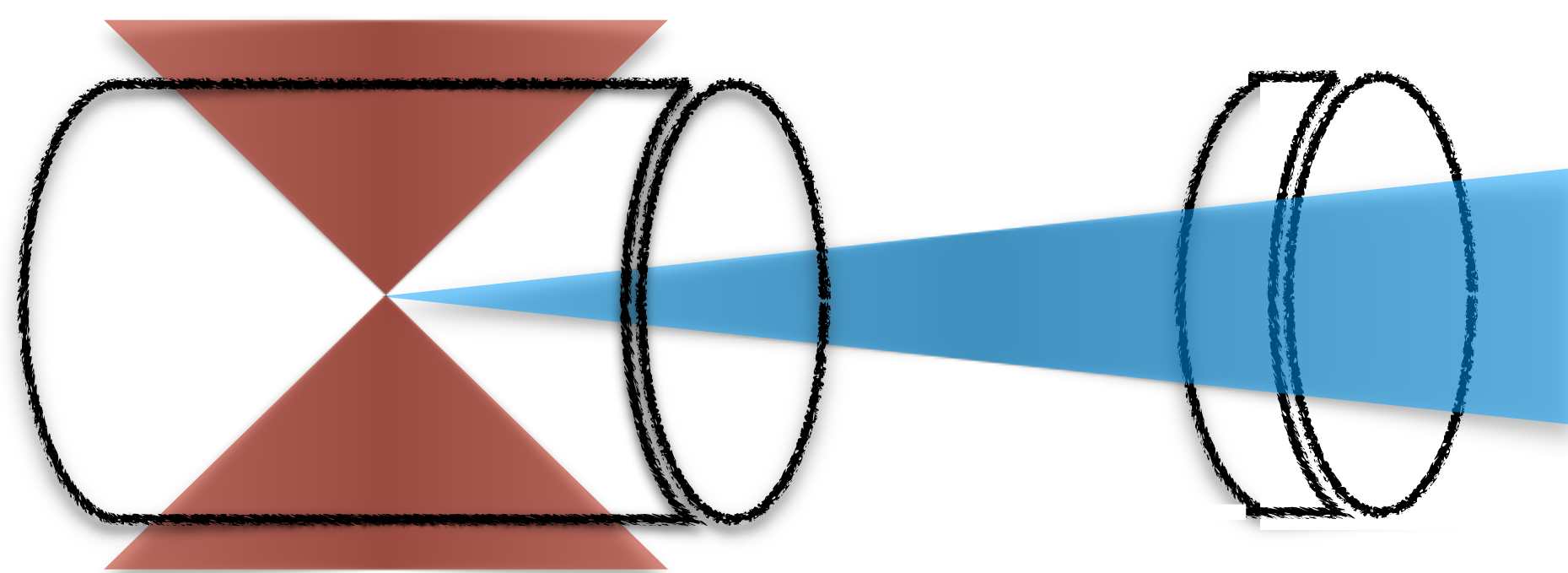

$$5 < |y_{D^*, \Lambda_c}| < 7$$

FPF

$$|y_{\text{Higgs}}| < 2.5$$

ATLAS barrel

(charm + Higgs) [\[F. G. C. et al., Phys. Rev. D 105 \(2022\) 11, 114056\]](#)

(light mesons + heavy flavor) [\[F. G. C., Phys. Rev. D 105 \(2022\) 11, 114008\]](#)

Backup

High-energy QCD in ultraforward directions

Backup

Physics Reports 968 (2022) 1–50

Contents lists available at ScienceDirect

Physics Reports

journal homepage: www.elsevier.com/locate/physrep



The Forward Physics Facility: Sites, experiments, and physics potential

Luis A. Anchordoqui¹, Akitaka Ariga^{2,3}, Tomoko Ariga⁴, Weidong Bai⁵, Kinso Balazs⁶, Brian Batell⁷, Jamie Boyd⁶, Joseph Bramante⁸, Mario Campanelli⁹, Adrian Carmona¹⁰, **Francesco G. Celiberto**^{11,12,13}, Grigorios Chachamis¹⁴, Matthew Citron¹⁵, Giovanni De Lellis^{16,17}, Albert De Roeck⁶, Hans Dembinski¹⁸, Peter B. Denton¹⁹, Antonia Di Crescenzo^{16,17,6}, Milind V. Diwan²⁰, Liam Dougherty²¹, Herbi K. Dreiner²², Yong Du²³, Rikard Enberg²⁴, Yasaman Farzan²⁵, Jonathan L. Feng^{26,*}, Max Fieg²⁶, Patrick Foldenauer²⁷, Saeid Foroughi-Abari²⁸, Alexander Friedland²⁹, Michael Fucilla^{30,31}, Jonathan Gall³², Maria Vittoria Garzelli^{33,*}, Francesco Giuliani³⁴, Victor P. Goncalves³⁵, Marco Guzzi³⁶, Francis Halzen³⁷, Juan Carlos Helo^{38,39}, Christopher S. Hill⁴⁰, Ahmed Ismail⁴¹, Ameen Ismail⁴², Richard Jacobsson⁶, Sudip Jana⁴³, Yu Seon Jeong⁴⁴, Krzysztof Jodłowski⁴⁵, Kevin J. Kelly⁴⁶, Felix Kling^{29,47,**}, Fnu Karan Kumar²⁰, Zhen Liu⁴⁸, Rafał Maciuła⁴⁹, Roshan Mammen Abraham⁴¹, Julien Manshanden³³, Josh McFayden⁵⁰, Mohammed M.A. Mohammed^{30,31}, Pavel M. Nadolsky⁵¹, Nobuchika Okada⁵², John Osborne⁶, Hidetoshi Otono⁴, Vishvas Pandey^{53,46}, Alessandro Papa^{30,31}, Digesh Raut⁵⁴, Mary Hall Reno⁵⁵, Filippo Resnati⁶, Adam Ritz²⁸, Juan Rojo⁵⁶, Ina Sarcevic⁵⁷, Christiane Scherb⁵⁸, Holger Schulz⁵⁹, Pedro Schwaller⁶⁰, Dipan Sengupta⁶¹, Torbjörn Sjöstrand⁶², Tyler B. Smith²⁶, Dennis Soldin⁵⁴, Anna Stasto⁶³, Antoni Szczurek⁴⁹, Zahra Tabrizi⁶⁴, Sebastian Trojanowski^{65,66}, Yu-Dai Tsai^{26,46}, Douglas Tuckler⁶⁷, Martin W. Winkler⁶⁸, Keping Xie⁷, Yue Zhang⁶⁷

¹ Department of Physics and Astronomy, Lehman College, City University of New York, Bronx, NY 10468, USA

² Albert Einstein Center for Fundamental Physics, Laboratory for High Energy Physics, University of Bern, Sidlerstrasse 5, CH-3012 Bern, Switzerland

³ Department of Physics, Chiba University, 1-33 Yayoi-cho Inage-ku, Chiba, 263-8522, Japan

⁴ Kyushu University, Nishi-ku, 819-0395 Fukuoka, Japan

⁵ Sun Yat-sen University, School of Physics, No. 135, Xingang Xi Road, Guangzhou, 510275, PR China

⁶ CERN, CH-1211 Geneva 23, Switzerland

⁷ PITT PACS, Department of Physics and Astronomy, University of Pittsburgh, Pittsburgh, PA 15260, USA

⁸ Department of Physics, Queen's University, Kingston, ON K7L 2S8, Canada

⁹ Department of Physics & Astronomy, University College London, Gower Street, London, WC1E 6BT, United Kingdom

¹⁰ CAFPE and Departamento de Física Teórica y del Cosmos, Universidad de Granada, E18071 Granada, Spain

¹¹ European Centre for Theoretical Studies in Nuclear Physics and Related Areas (ECT*), I-38123 Villazzano, Trento, Italy

¹² Fondazione Bruno Kessler (FBK), I-38123 Povo, Trento, Italy

¹³ INFN-TIFPA Trento Institute of Fundamental Physics and Applications, I-38123 Povo, Trento, Italy

* Corresponding authors.

** Corresponding author at: Deutsches Elektronen-Synchrotron DESY, Notkestrasse 85, 22607 Hamburg, Germany.
E-mail addresses: jlf@uci.edu (J.L. Feng), maria.vittoria.garzelli@desy.de (M.V. Garzelli), felix.kling@desy.de (F. Kling).

<https://doi.org/10.1016/j.physrep.2022.04.004>

0370-1573/© 2022 The Authors. Published by Elsevier B.V. This is an open access article under the CC BY license (<http://creativecommons.org/licenses/by/4.0/>).

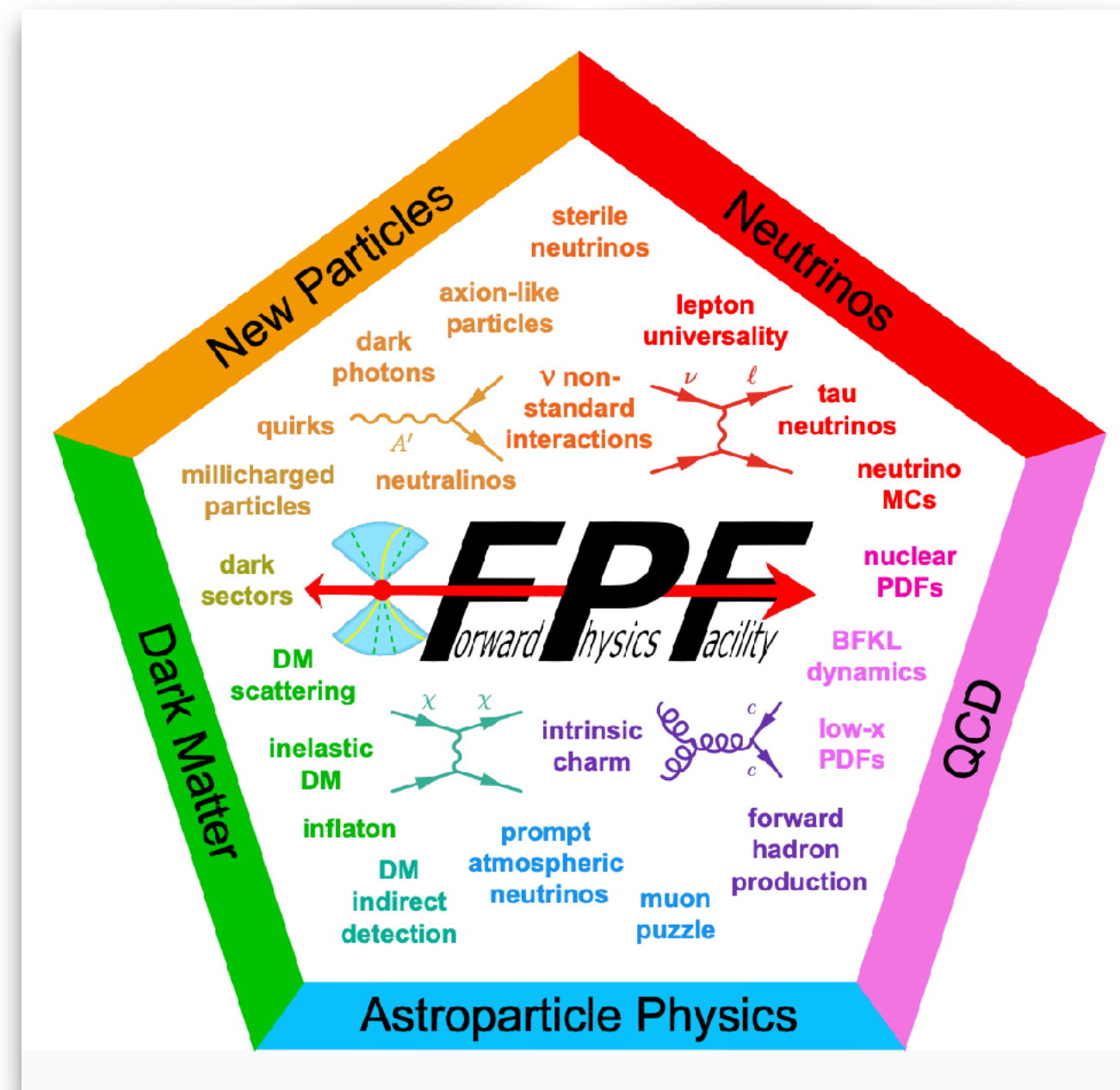

[FPF Snowmass Whitepaper]

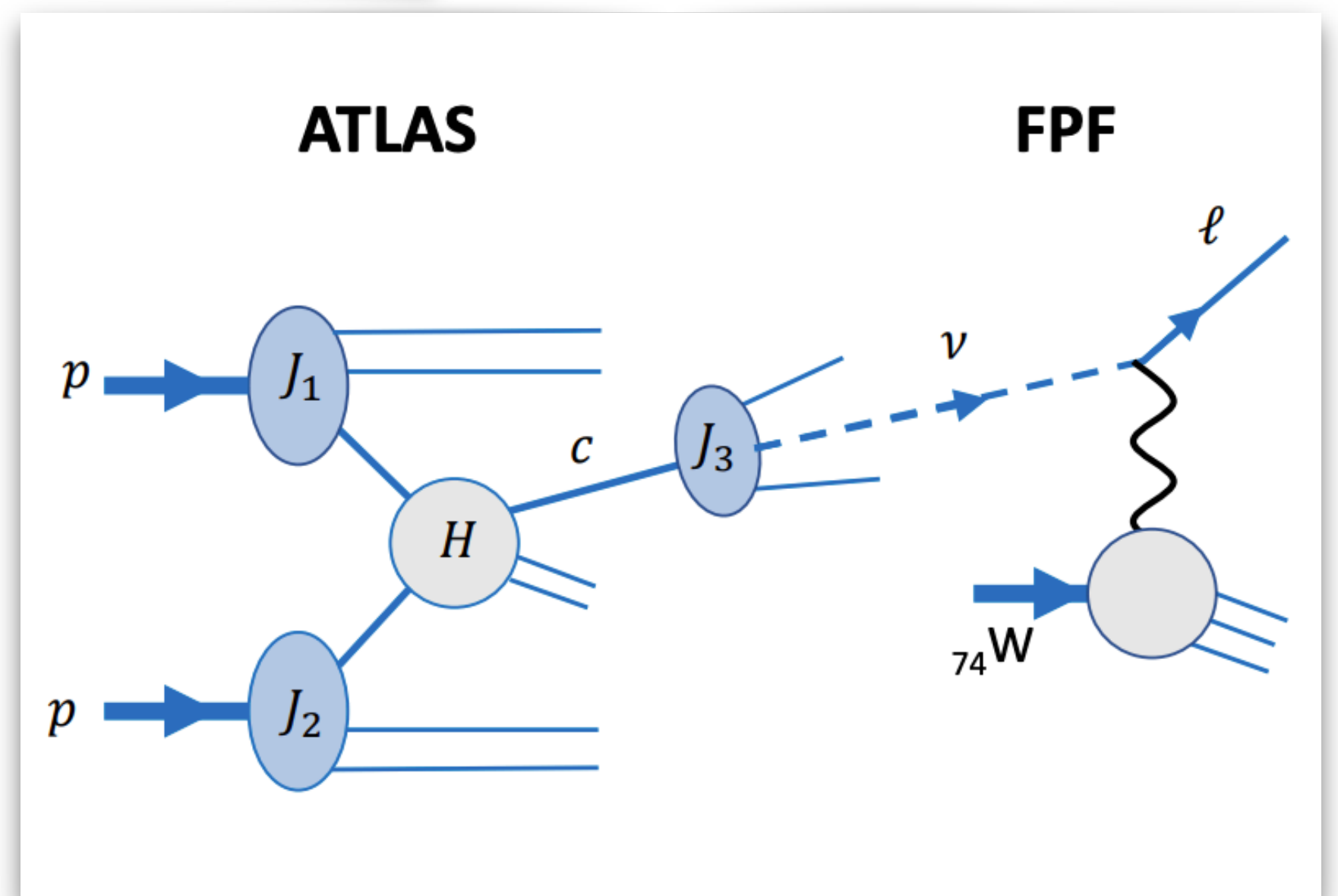

Rapidity distributions @FPF+ATLAS

Inclusive π^\pm (FPF) + $D^{*\pm}$ (ATLAS) production

[\[FPF Snowmass Whitepaper\]](#)

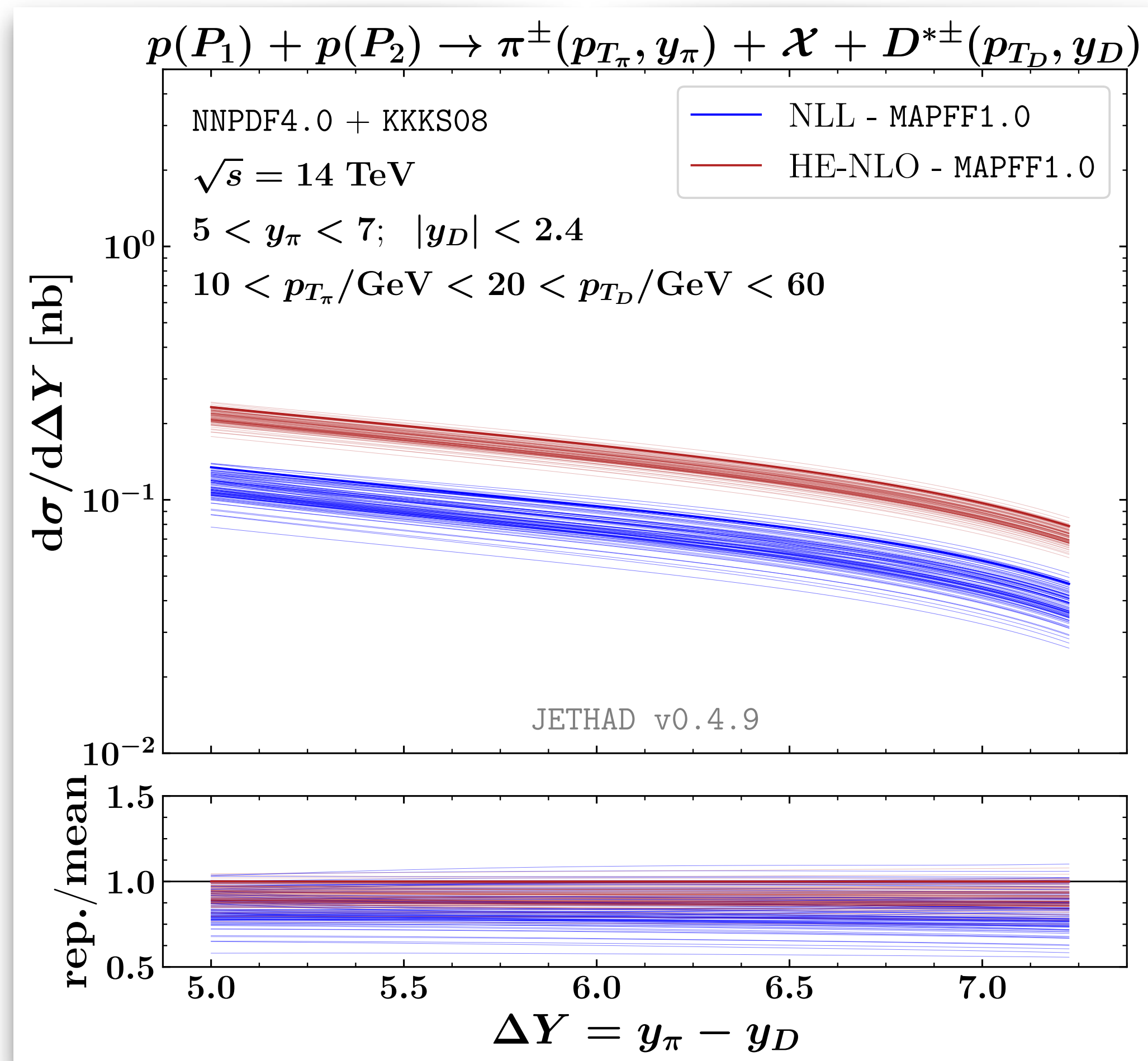

Rapidity distributions @FPF+ATLAS

Inclusive π^\pm (FPF) + $D^{*\pm}$ (ATLAS) production

[\[FPF Snowmass Whitepaper\]](#)

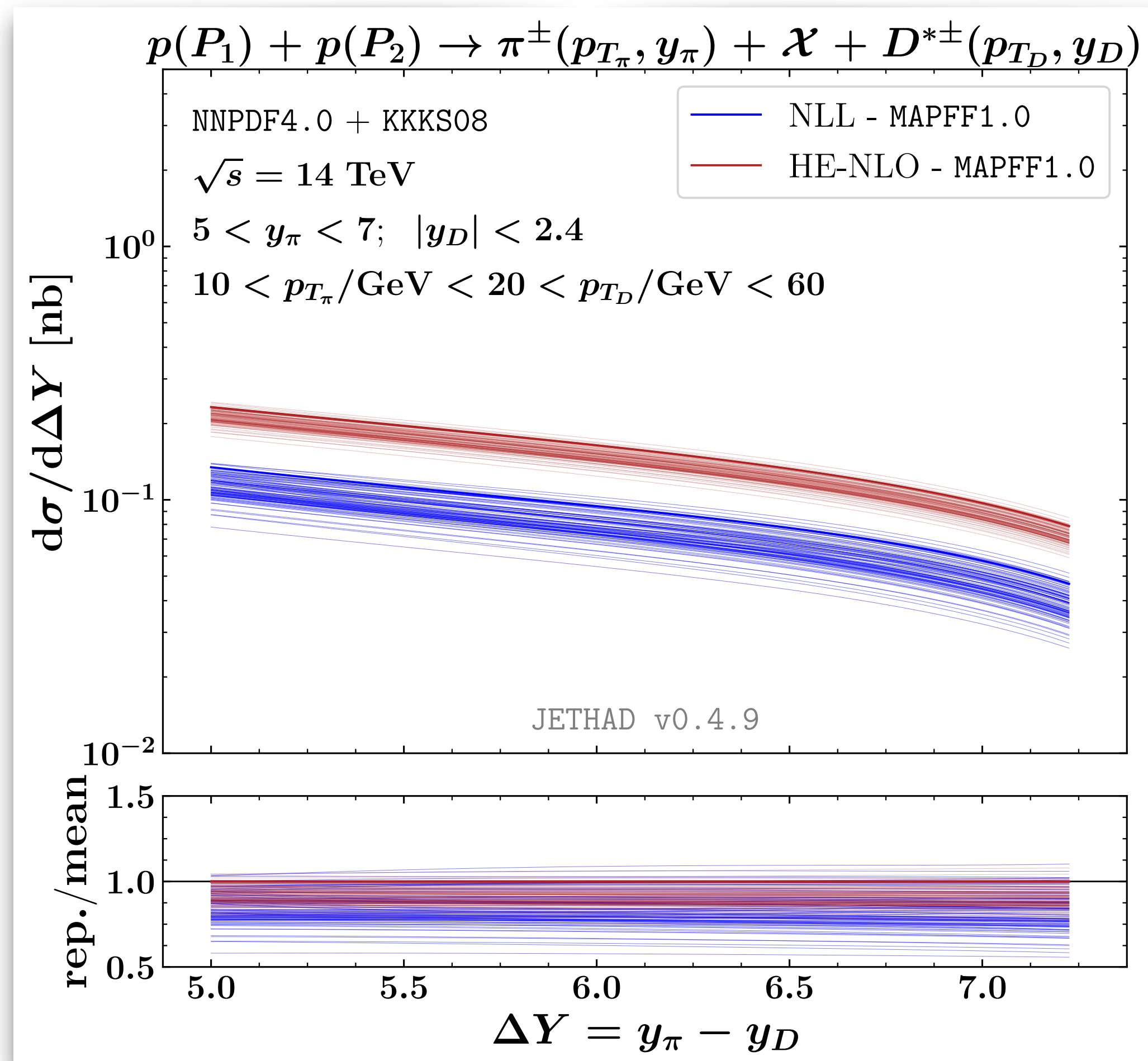

* Impact of collinear FFs on ΔY -distribution

* Replica method at work

Rapidity distributions @FPF+ATLAS

Inclusive π^\pm (FPF) + $D^{*\pm}$ (ATLAS) production

[\[FPF Snowmass Whitepaper\]](#)

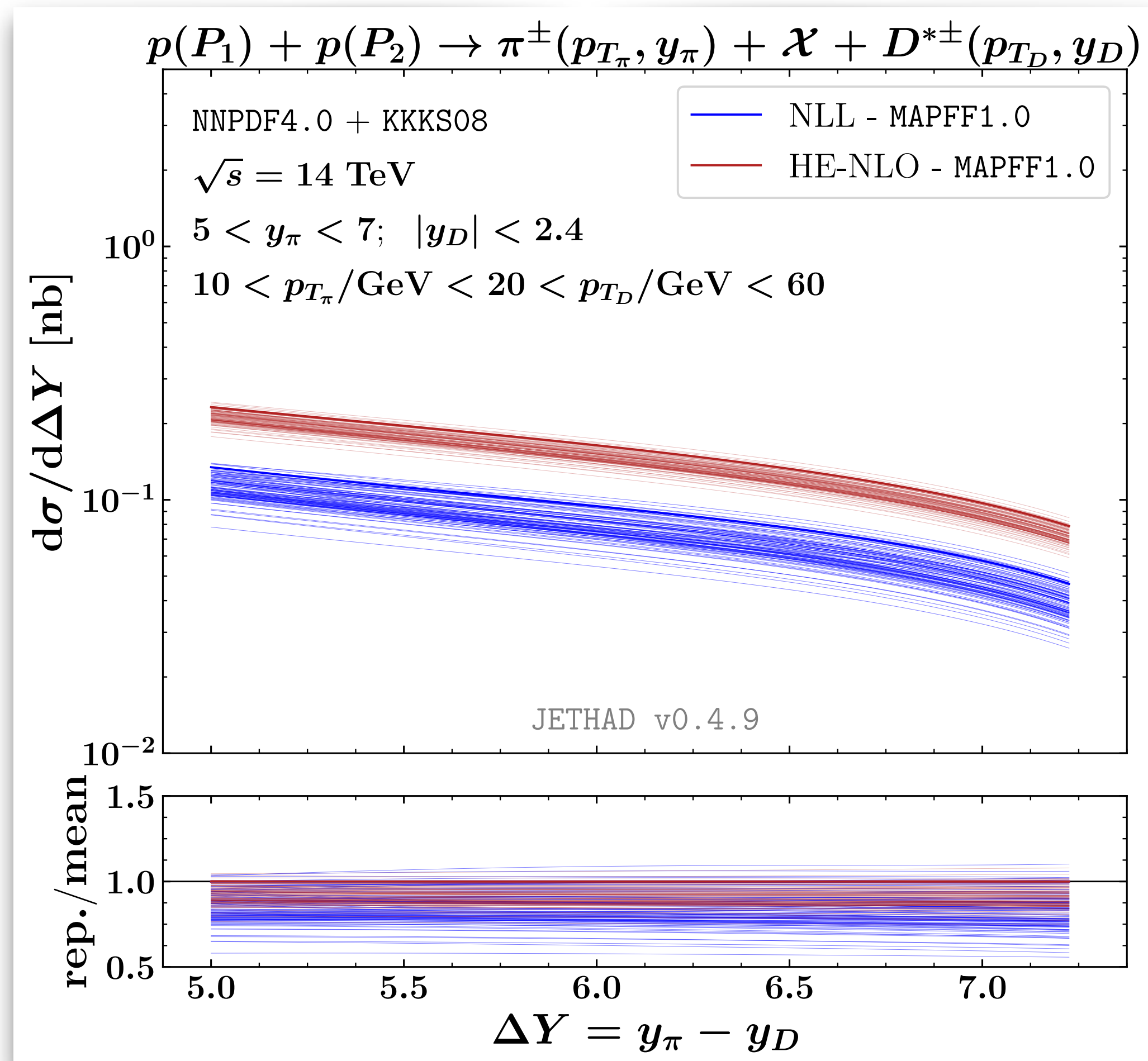

- * Impact of collinear FFs on ΔY -distribution
- * Replica method at work
- * Larger spread of replicas at NLL
- * Probe FFs in complementary ranges
 - Weight of FF replicas in the same set
 - Different sets via functional correlation?
- * Complementary studies on FFs

Rapidity distributions @FPF+ATLAS

Inclusive π^\pm (FPF) + $D^{*\pm}$ (ATLAS) ΔY -spectrum

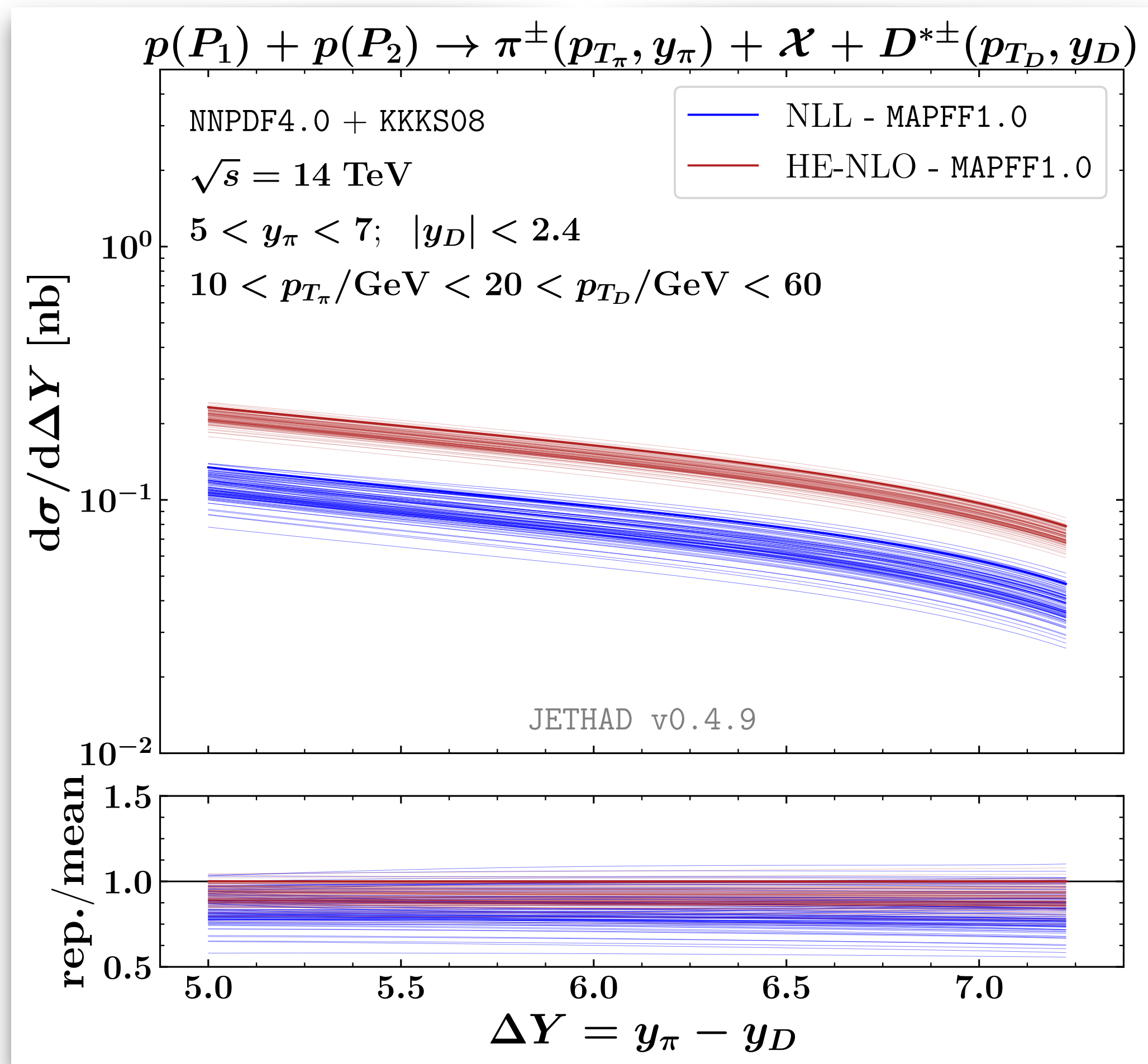

Inclusive π^\pm (FPF) + $D^{*\pm}$ (ATLAS) $\Delta\phi$ -spectrum

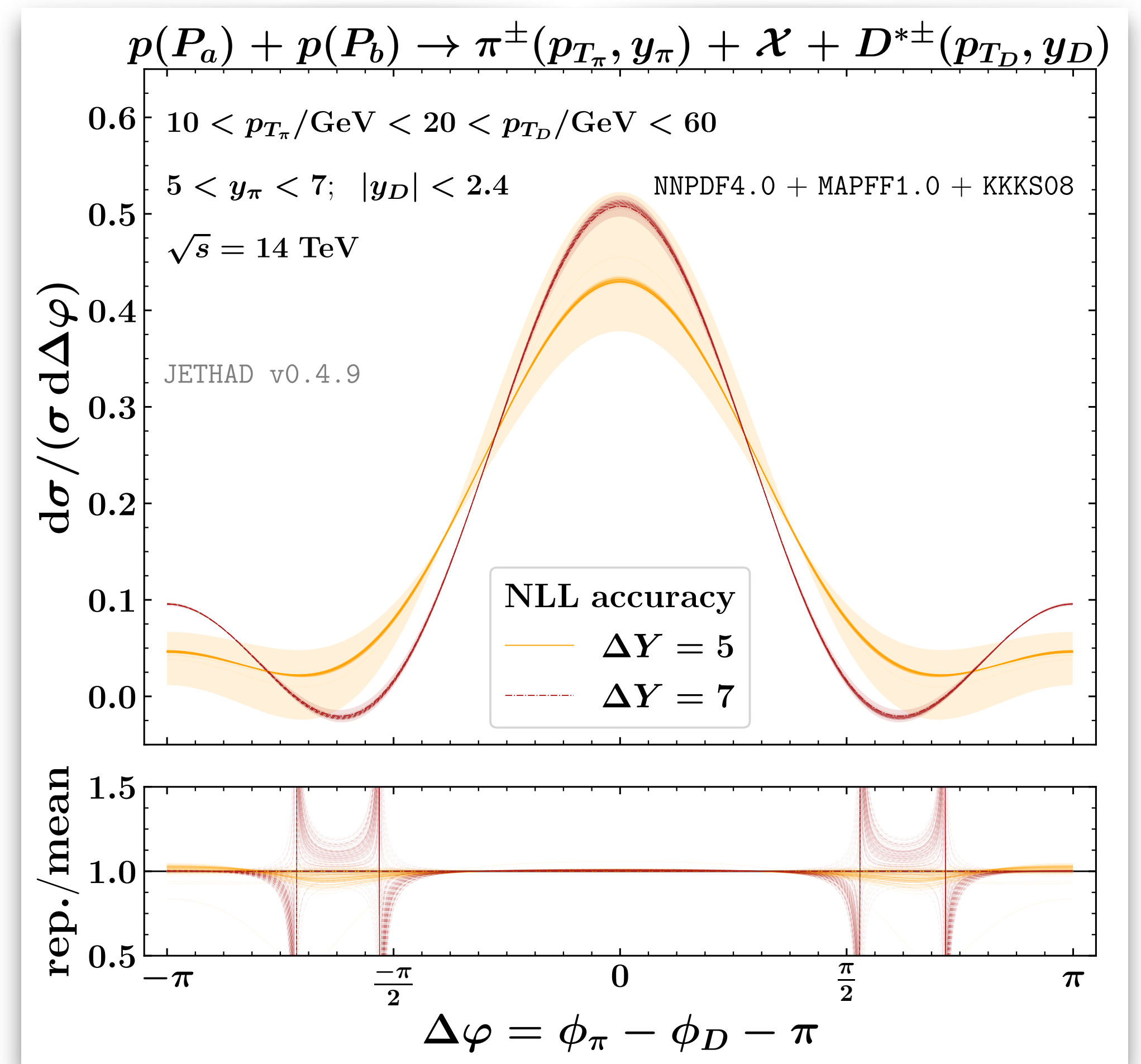

HIGGS + JET DISTRIBUTIONS

Inclusive Higgs + jet at the LHC

- Inclusive h.p. of a Higgs + jet system with high p_T and large rapidity separation, ΔY
- Large energy scales expected to **stabilize** the high-energy resummed series

$$\frac{d\sigma}{dx_1 dx_2 d|\vec{p}_H| d|\vec{p}_J| d\varphi_H d\varphi_J} = \frac{1}{(2\pi)^2} \left[\mathcal{C}_0 + \sum_{n=1}^{\infty} 2 \cos(n\varphi) \mathcal{C}_n \right]$$

$$\varphi = \varphi_H - \varphi_J - \pi$$

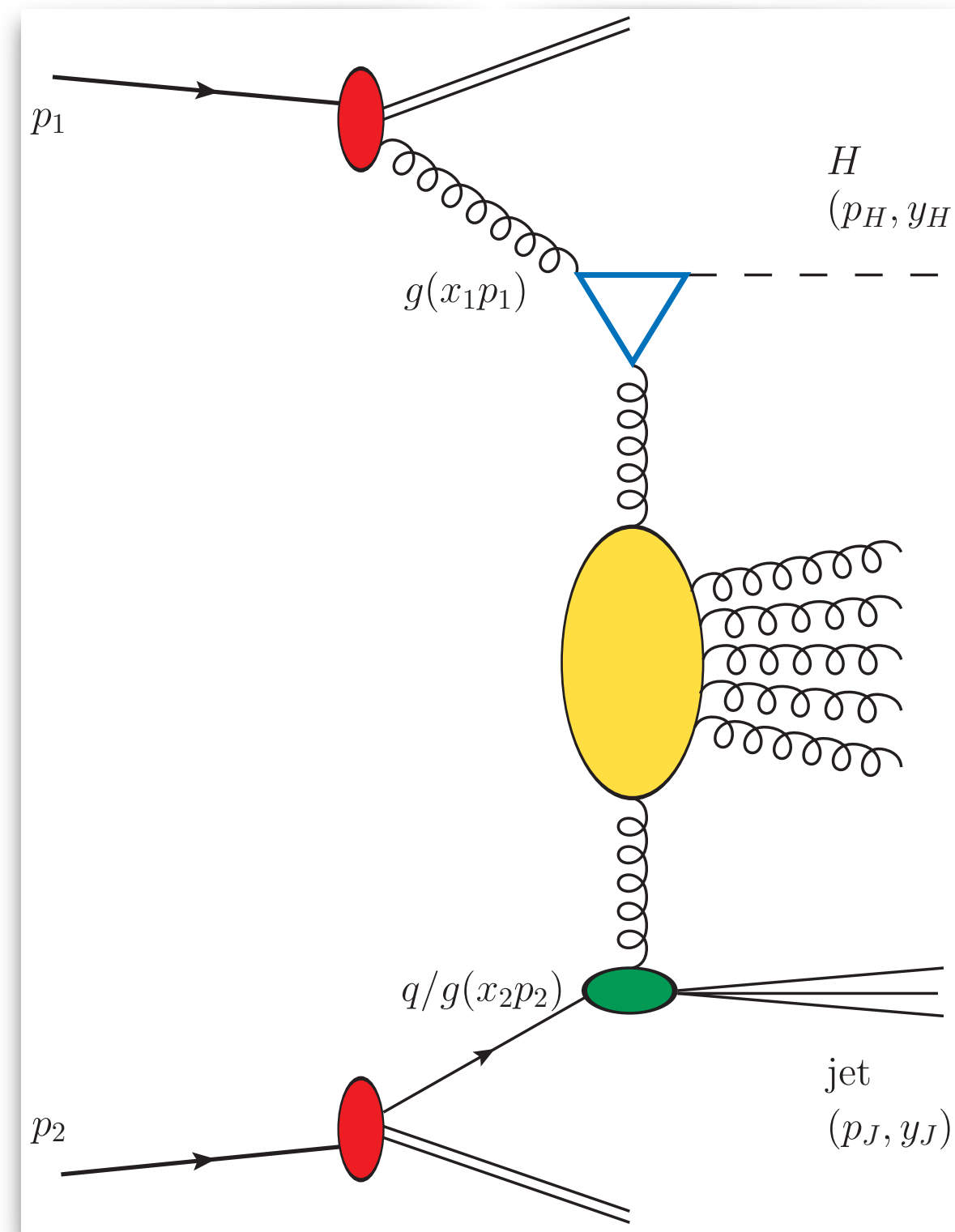

Inclusive Higgs + jet at the LHC

- Inclusive h.p. of a Higgs + jet system with high p_T and large rapidity separation, ΔY
- Large energy scales expected to **stabilize** the high-energy resummed series

$$\frac{d\sigma}{dx_1 dx_2 d|\vec{p}_H| d|\vec{p}_J| d\varphi_H d\varphi_J} = \frac{1}{(2\pi)^2} \left[\mathcal{C}_0 + \sum_{n=1}^{\infty} 2 \cos(n\varphi) \mathcal{C}_n \right]$$

$$\varphi = \varphi_H - \varphi_J - \pi$$

Higgs vertex
(off-shell coefficient function)

jet vertex
(off-shell coefficient function)

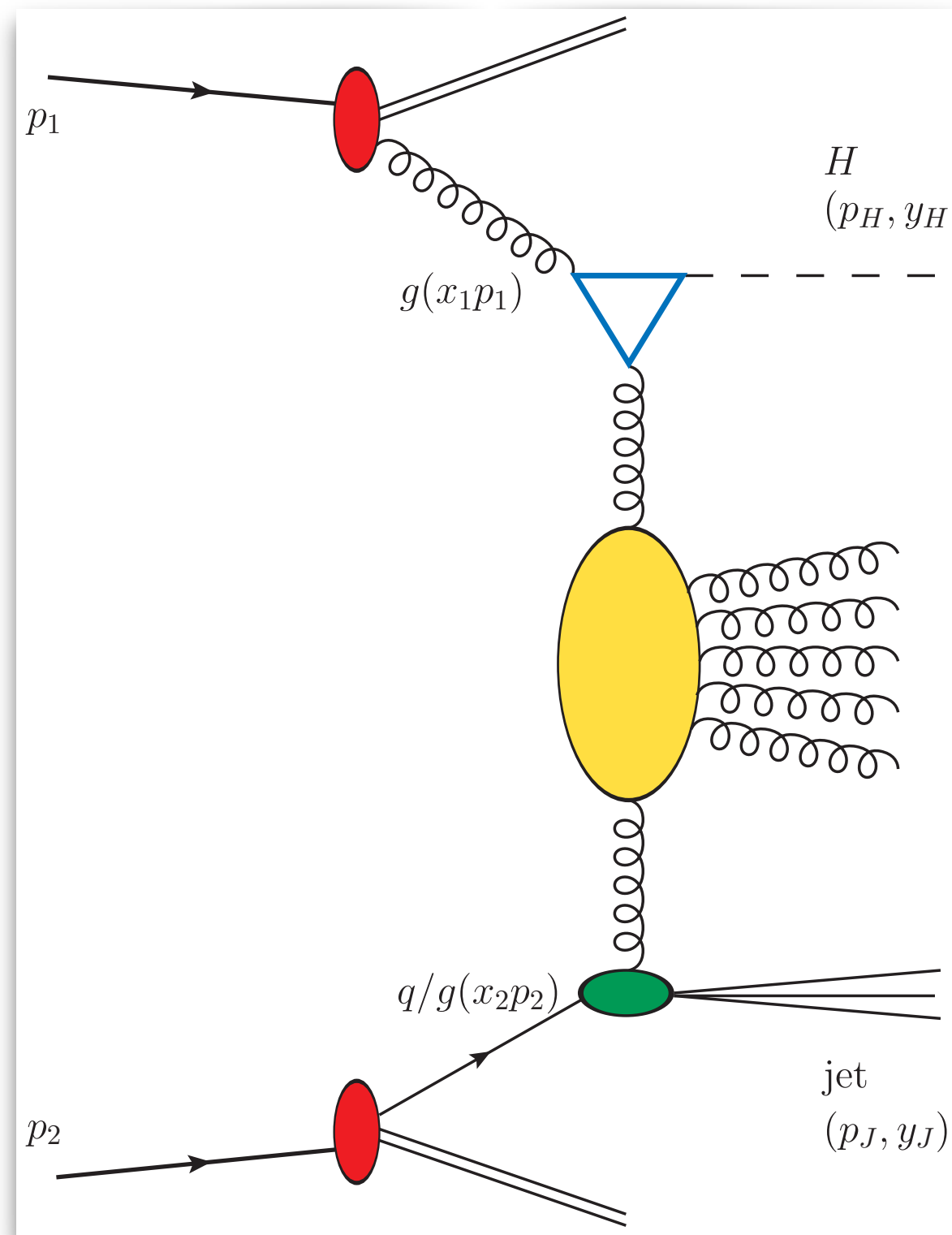

NLO*

NLL

NLO*

$$\frac{d\hat{\sigma}_{r,s}(x_1 x_2 s, \mu)}{dy_H dy_J d^2\vec{p}_H d^2\vec{p}_J} = \frac{1}{(2\pi)^2} \times \int \frac{d^2\vec{q}_1}{\vec{q}_1^2} \mathcal{V}_H^{(r)}(\vec{q}_1, s_0, x_1, \vec{p}_H) \times \int_{\delta-i\infty}^{\delta+i\infty} \frac{d\omega}{2\pi i} \left(\frac{x_1 x_2 s}{s_0} \right)^\omega \mathcal{G}_\omega(\vec{q}_1, \vec{q}_2) \times \int \frac{d^2\vec{q}_2}{\vec{q}_2^2} \mathcal{V}_J^{(s)}(\vec{q}_2, s_0, x_2, \vec{p}_J)$$

BFKL Green's function

Inclusive Higgs + jet at the LHC

- Inclusive h.p. of a Higgs + jet system with high p_T and large rapidity separation, ΔY
- Large energy scales expected to stabilize the high-energy resummed series

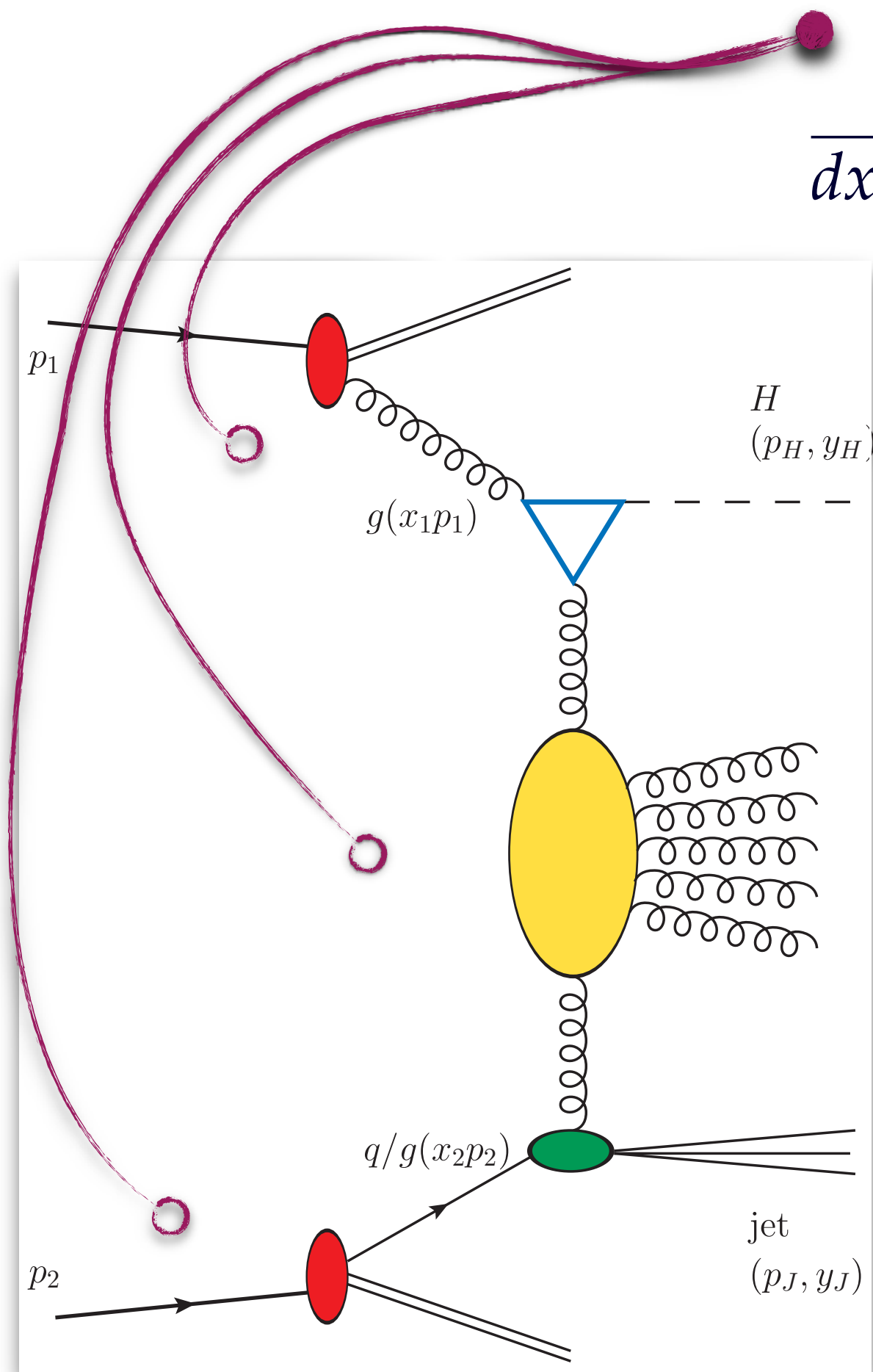

$$\frac{d\sigma}{dx_1 dx_2 d|\vec{p}_H| d|\vec{p}_J| d\varphi_H d\varphi_J} = \frac{1}{(2\pi)^2} \left[\mathcal{C}_0 + \sum_{n=1}^{\infty} 2 \cos(n\varphi) \mathcal{C}_n \right]$$

Higgs vertex
(off-shell coefficient function)

jet vertex
(off-shell coefficient function)

$$\varphi = \varphi_H - \varphi_J - \pi$$

$$\mu_{F,R} \sim M_{H,\perp}$$

$$\mu_R \sim \sqrt{M_{H,\perp} P_J}$$

$$\mu_{F,R} \sim P_J$$

NLO*

NLL

NLO*

$$\begin{aligned} \frac{d\hat{\sigma}_{r,s}(x_1 x_2 s, \mu)}{dy_H dy_J d^2\vec{p}_H d^2\vec{p}_J} &= \frac{1}{(2\pi)^2} \\ &\times \int \frac{d^2\vec{q}_1}{\vec{q}_1^2} \mathcal{V}_H^{(r)}(\vec{q}_1, s_0, x_1, \vec{p}_H) \\ &\times \int_{\delta-i\infty}^{\delta+i\infty} \frac{d\omega}{2\pi i} \left(\frac{x_1 x_2 s}{s_0} \right)^\omega \mathcal{G}_\omega(\vec{q}_1, \vec{q}_2) \\ &\times \int \frac{d^2\vec{q}_2}{\vec{q}_2^2} \mathcal{V}_J^{(s)}(\vec{q}_2, s_0, x_2, \vec{p}_J) \end{aligned}$$

BFKL Green's function

The Higgs + jet spectrum in hybrid factorization

ΔY spectrum

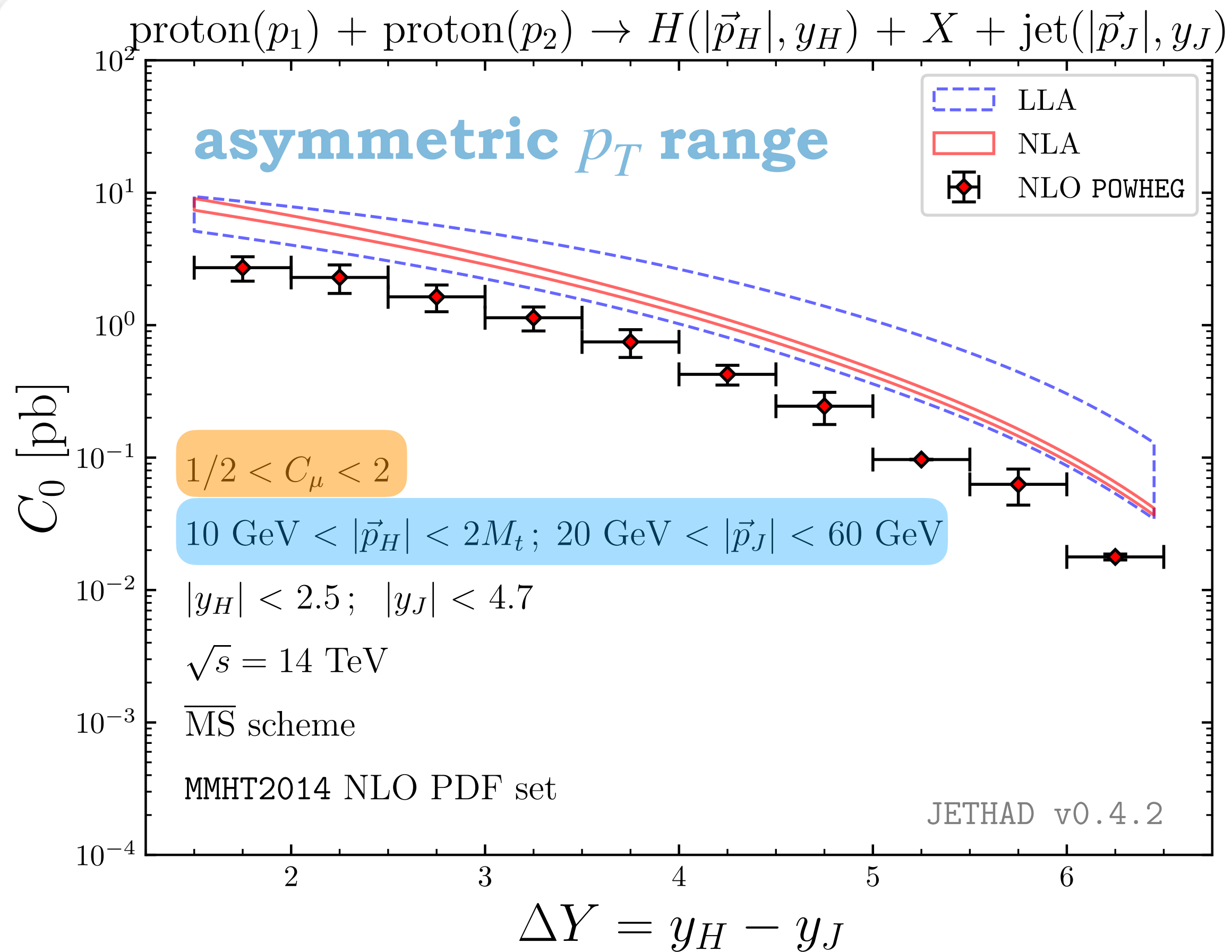

p_H spectrum

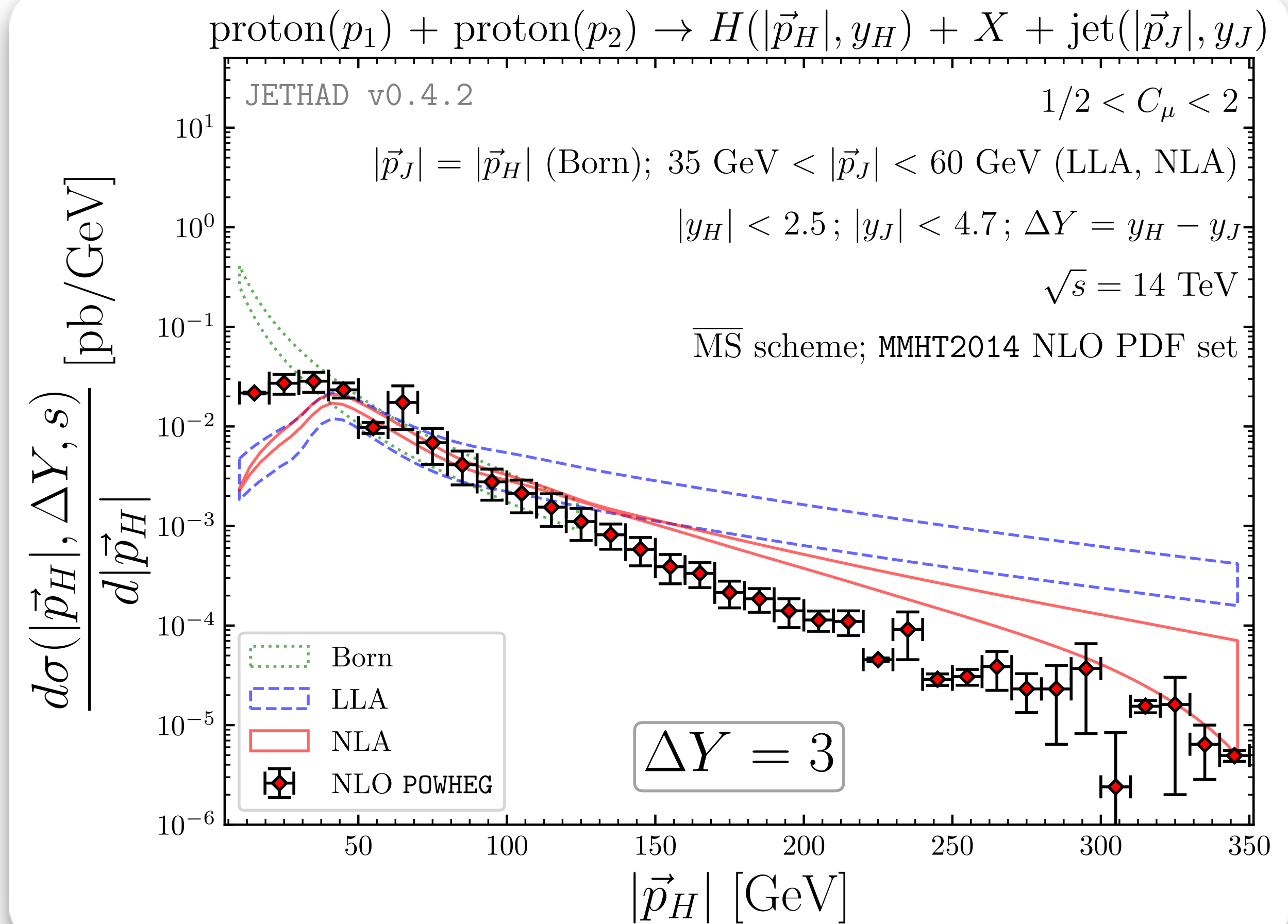

(in this slide) [\[F. G. C. et al., Eur. Phys. J. C 81 \(2021\) 4, 293\]](#)

(JETHAD) [\[F. G. C., Eur. Phys. J. C 81 \(2021\) 8, 691\]](#)

Higgs transverse-momentum distribution

$$\frac{d\sigma(|\vec{p}_H|, \Delta Y, s)}{d|\vec{p}_H|d\Delta Y} = \int_{p_J^{\min}}^{p_J^{\max}} d|\vec{p}_J| \int_{y_H^{\min}}^{y_H^{\max}} dy_H \int_{y_J^{\min}}^{y_J^{\max}} dy_J \delta(y_H - y_J - \Delta Y) \mathcal{C}_0$$

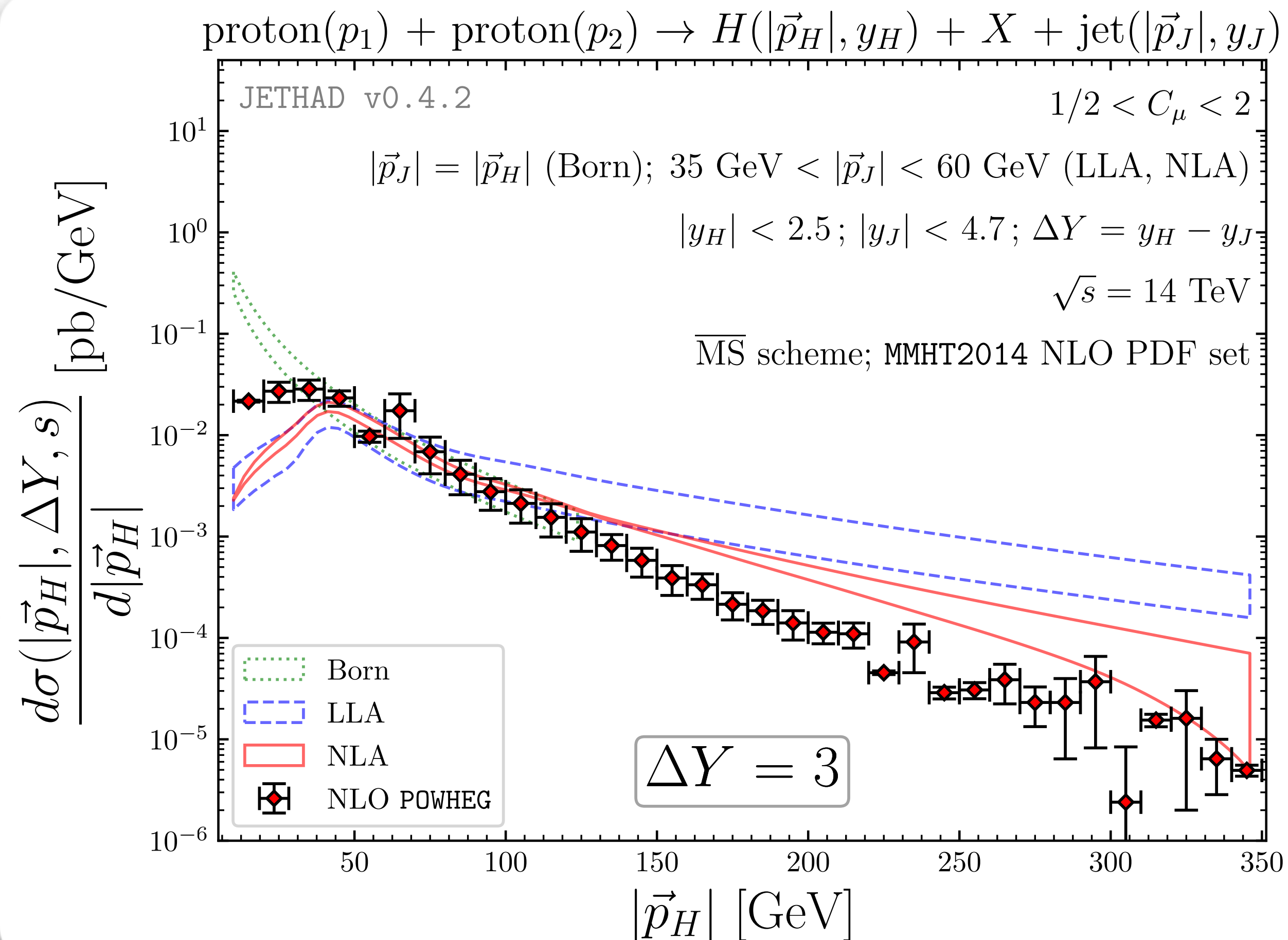

- HE resummation from **JETHAD**
- Comparison with fixed-order **POWHEG**
- Distributions stable under NLL corrections

ΔY -distribution

$$C_n(\Delta Y, s) = \int_{p_H^{\min}}^{p_H^{\max}} d|\vec{p}_H| \int_{p_J^{\min}}^{p_J^{\max}} d|\vec{p}_J| \int_{y_H^{\min}}^{y_H^{\max}} dy_H \int_{y_J^{\min}}^{y_J^{\max}} dy_J \delta(y_H - y_J - \Delta Y) C_n$$

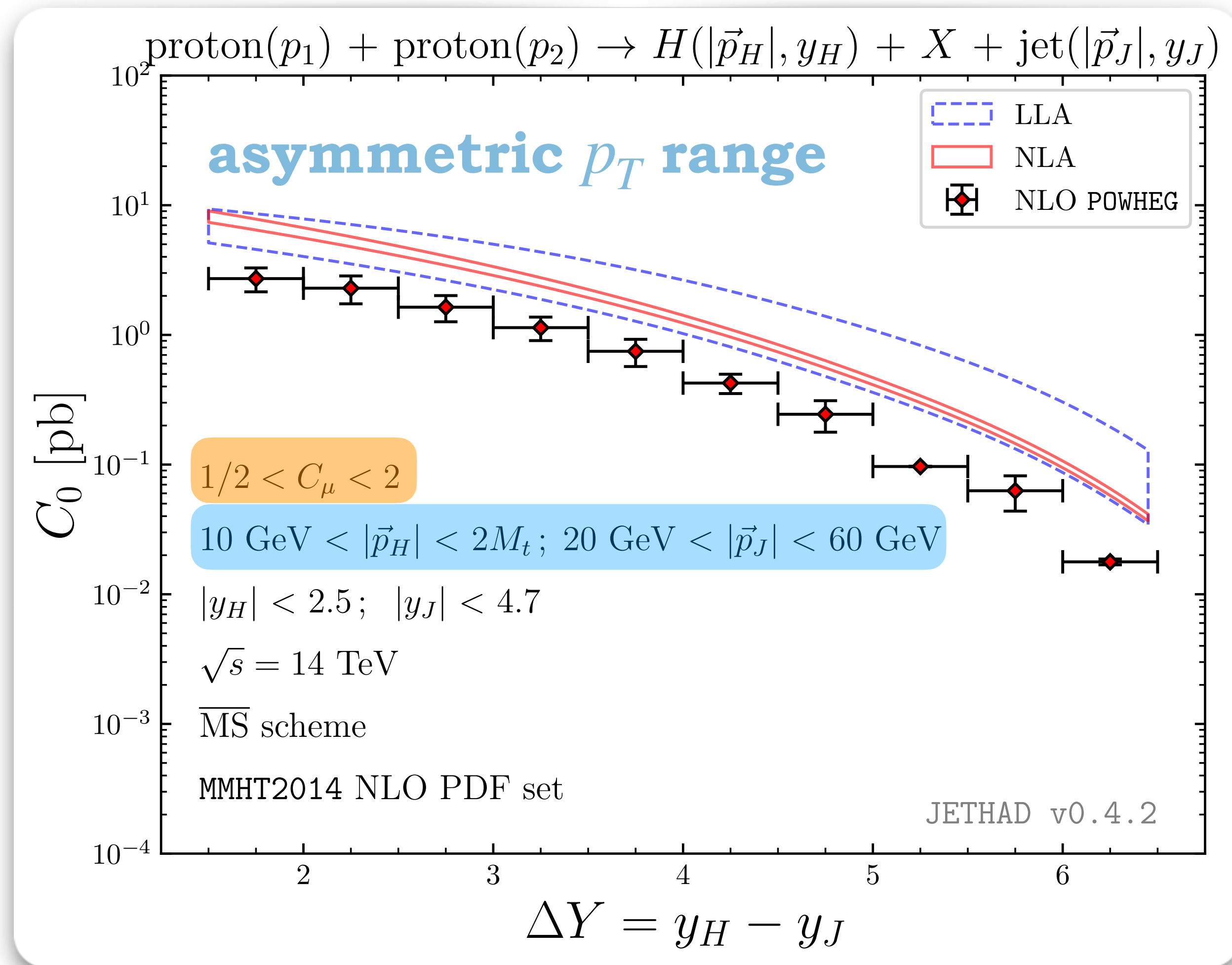

Angular correlations

$$R_{n0}(\Delta Y, s) = C_n/C_0 \equiv \langle \cos n\varphi \rangle$$

Mueller-Navelet jets

[\[B. Ducloué, L. Szymanowski, S. Wallon, Phys.Rev.Lett. 112 \(2014\) 082003\]](#)

(figure below) [\[F. G. C., Eur. Phys. J. C 81 \(2021\) 8, 691\]](#)

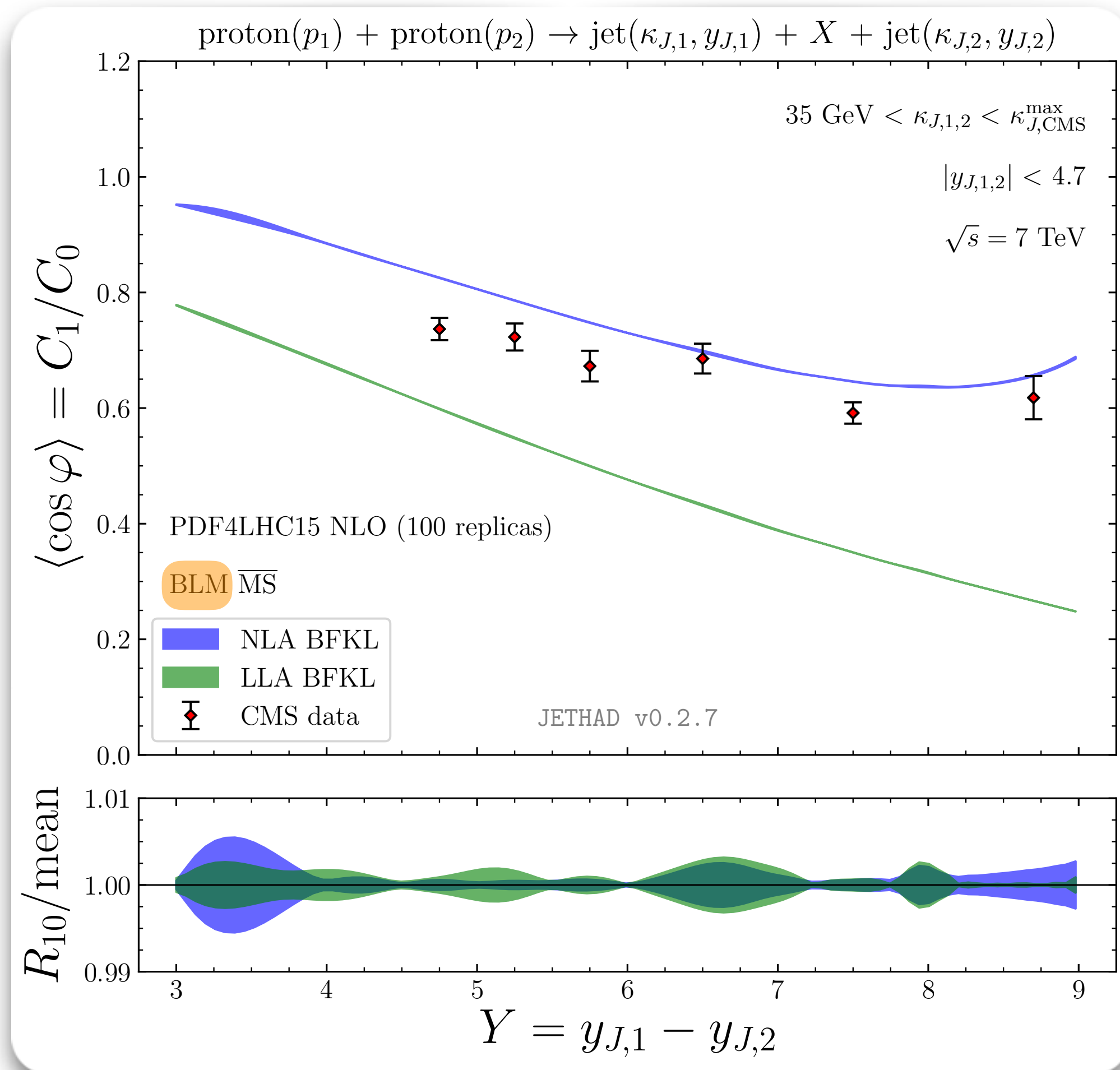

Angular correlations

$$R_{n0}(\Delta Y, s) = C_n/C_0 \equiv \langle \cos n\varphi \rangle$$

Mueller-Navelet jets

[B. Ducloué, L. Szymanowski, S. Wallon, Phys.Rev.Lett. 112 (2014) 082003]

(figure below) [F. G. C., Eur. Phys. J. C 81 (2021) 8, 691]

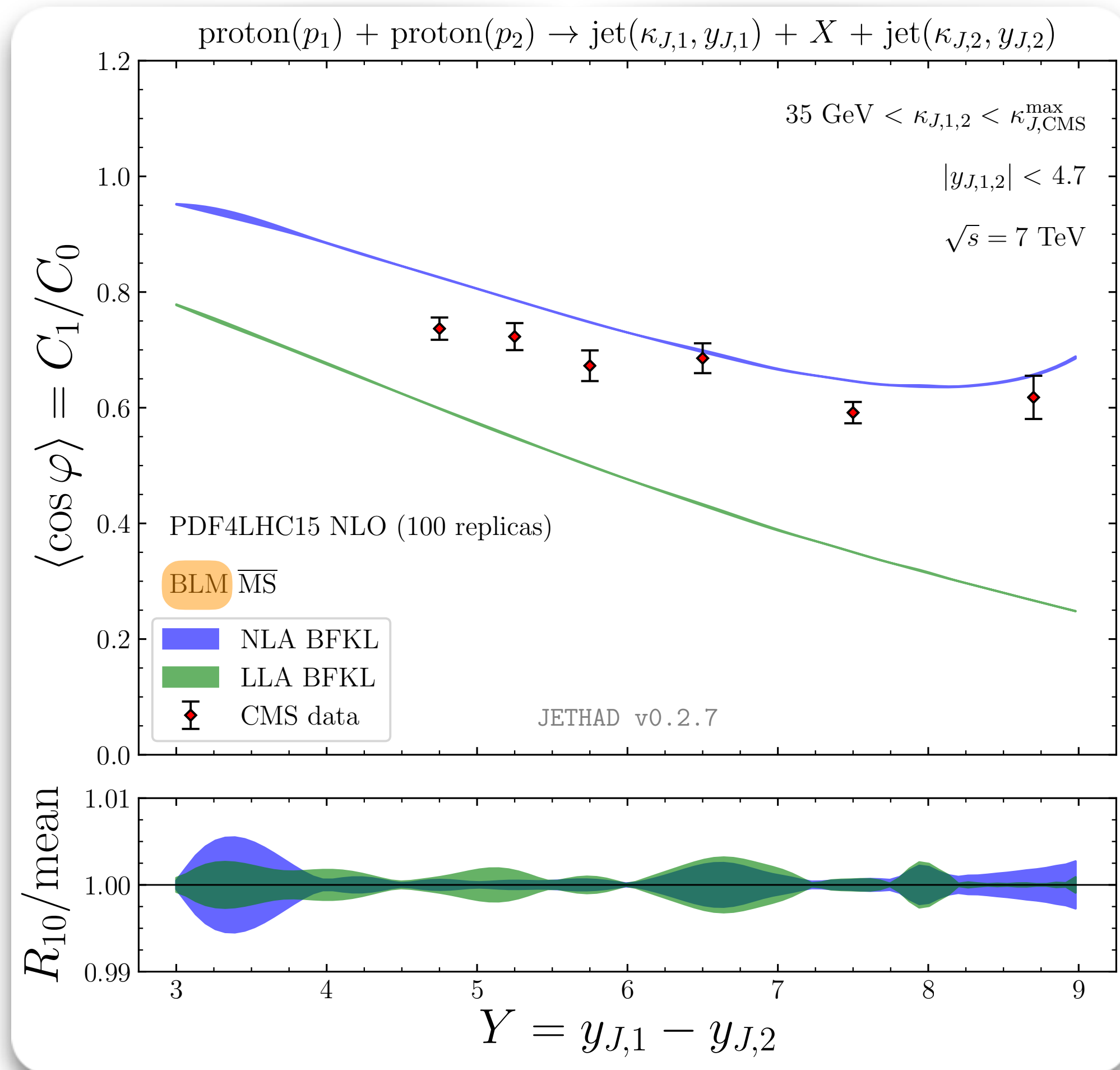

Higgs + jet

(figure below) [F. G. C. et al., Eur. Phys. J. C 81 (2021) 4, 293]

(NLO Higgs impact factor) [F. G. C. et al., under review (2022)]

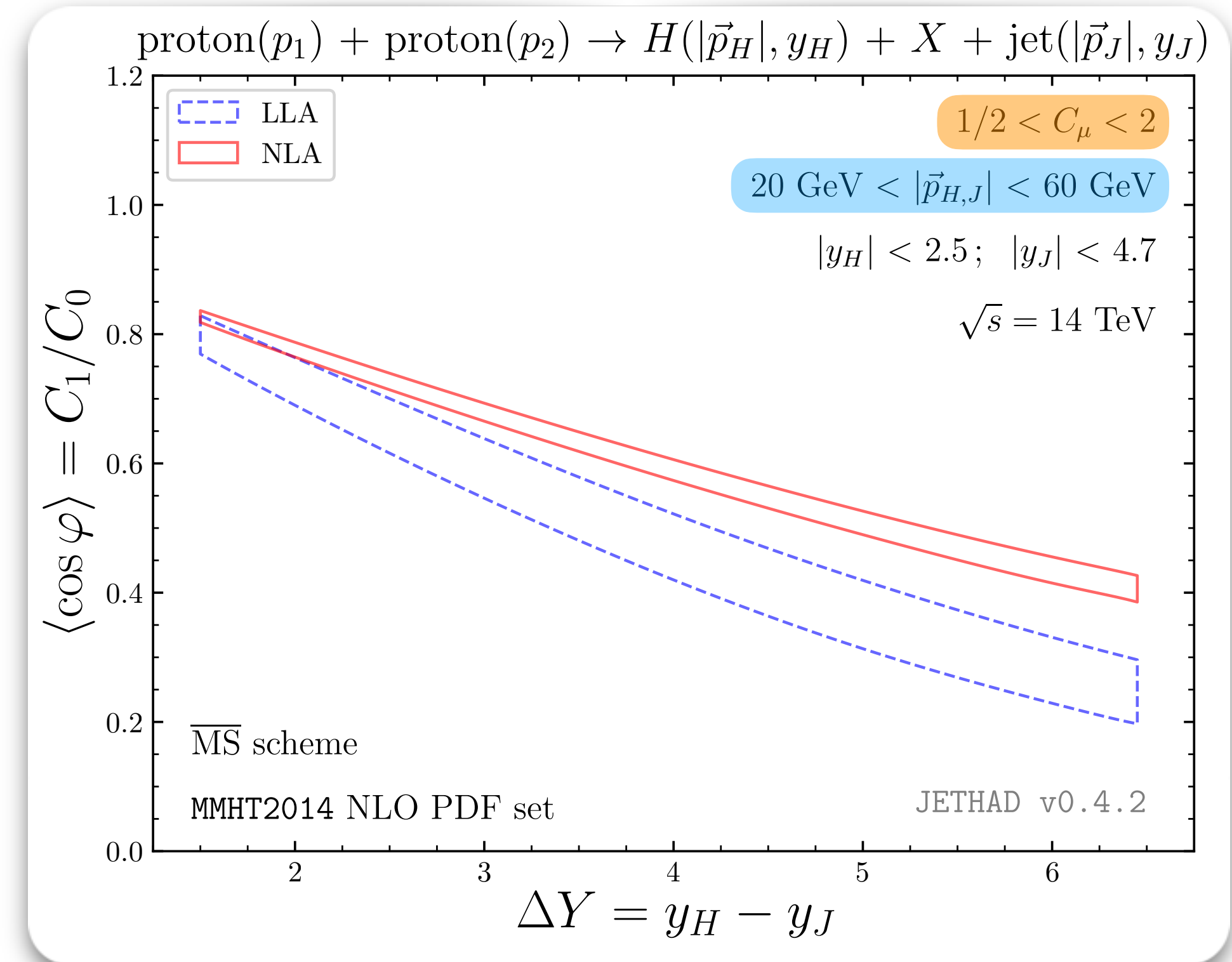

natural scales

symmetric p_T range

ΔY -distribution in the infinite top-mass limit

$$C_n(\Delta Y, s) = \int_{p_H^{\min}}^{p_H^{\max}} d|\vec{p}_H| \int_{p_J^{\min}}^{p_J^{\max}} d|\vec{p}_J| \int_{y_H^{\min}}^{y_H^{\max}} dy_H \int_{y_J^{\min}}^{y_J^{\max}} dy_J \delta(y_H - y_J - \Delta Y) C_n$$

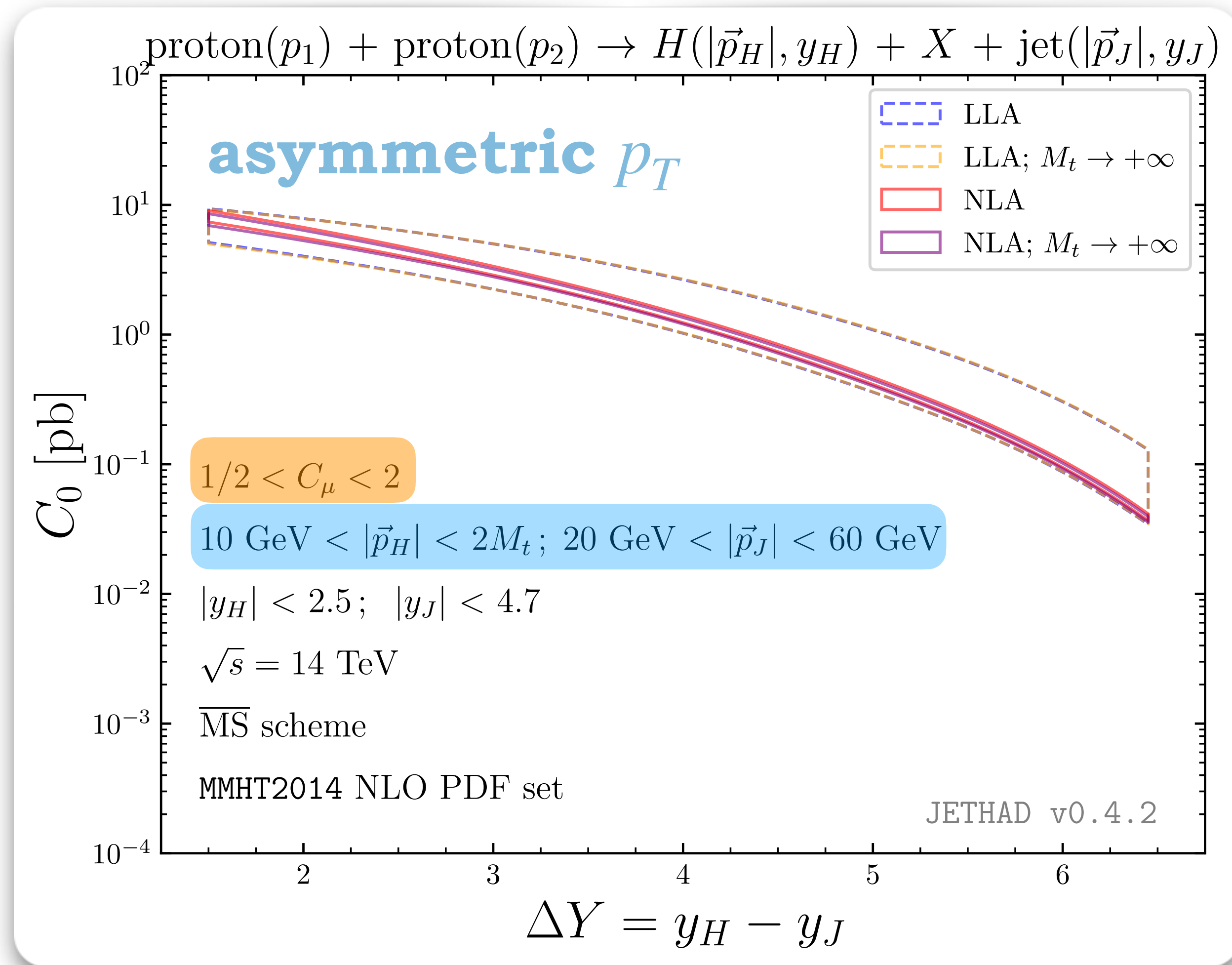

Angular correlations in the infinite top-mass limit

$$R_{n0}(\Delta Y, s) = C_n/C_0 \equiv \langle \cos n\varphi \rangle$$

Mueller-Navelet jets

[\[B. Ducloué, L. Szymanowski, S. Wallon, Phys.Rev.Lett. 112 \(2014\) 082003\]](#)

(figure below) [\[F. G. C., Eur. Phys. J. C 81 \(2021\) 8, 691\]](#)

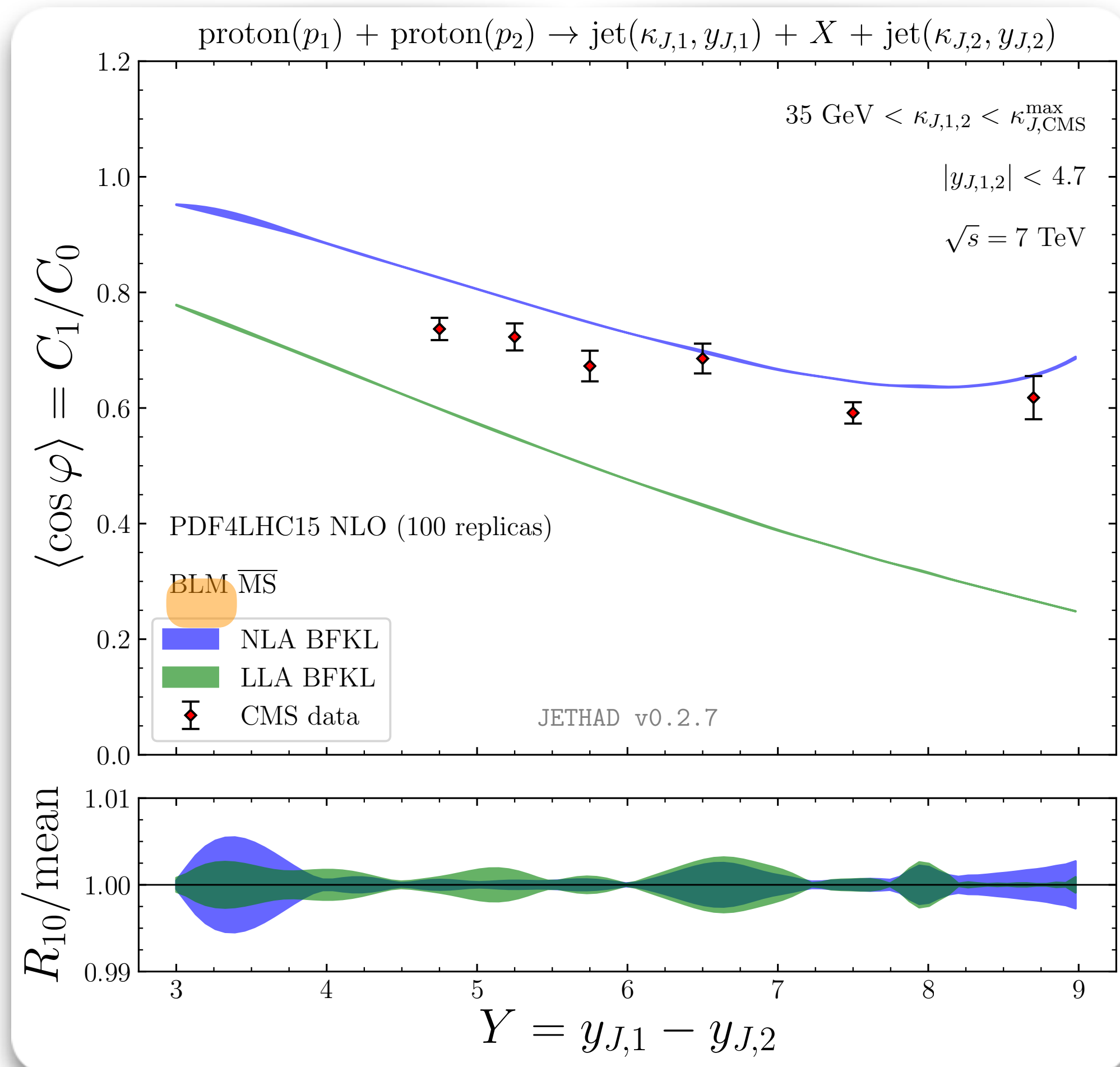

Angular correlations in the infinite top-mass limit

$$R_{n0}(\Delta Y, s) = C_n/C_0 \equiv \langle \cos n\varphi \rangle$$

Mueller-Navelet jets

[B. Ducloué, L. Szymanowski, S. Wallon, Phys.Rev.Lett. 112 (2014) 082003]

(figure below) [F. G. C., Eur. Phys. J. C 81 (2021) 8, 691]

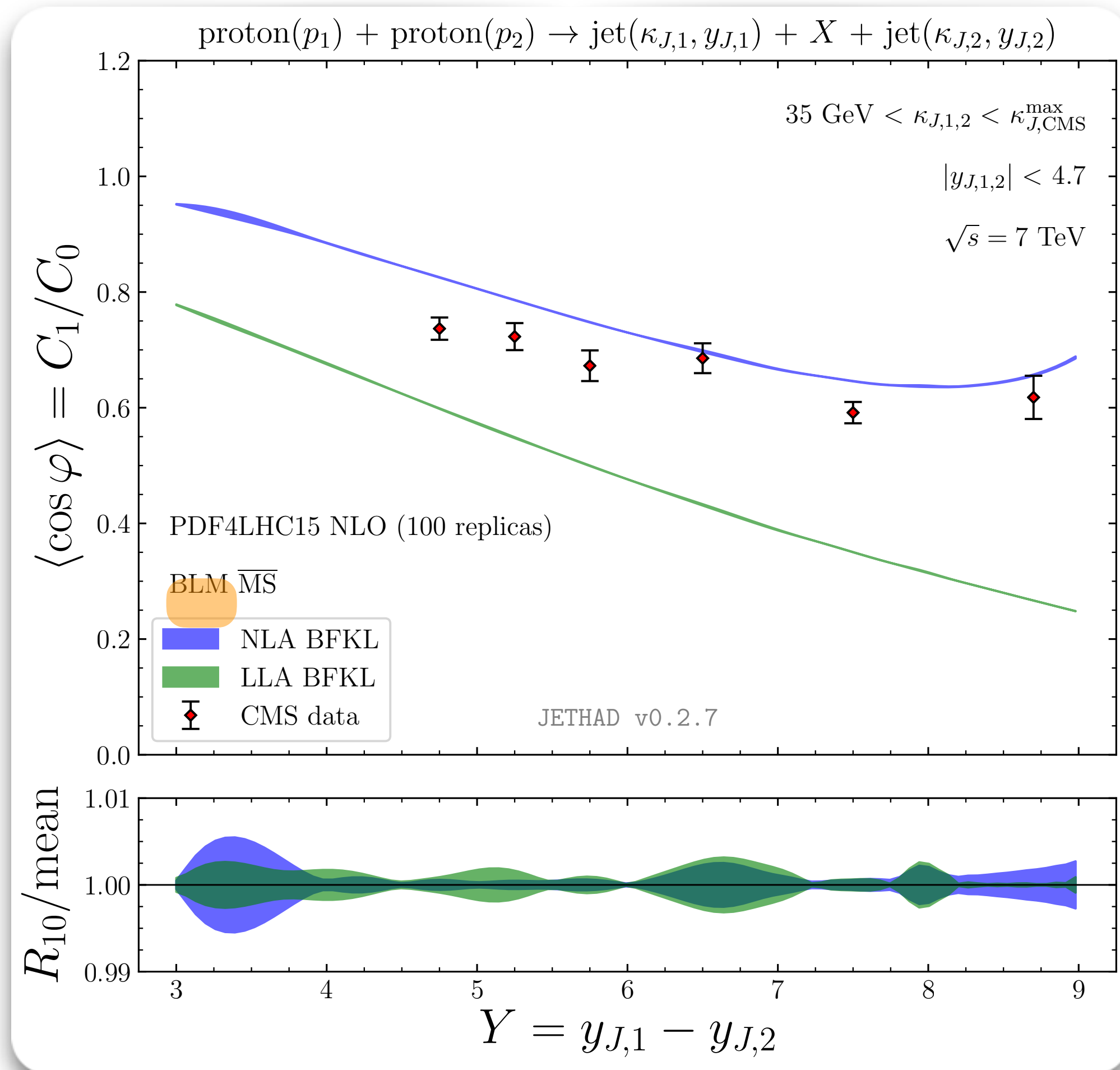

Higgs + jet

(figure below) [F. G. C. et al., Eur. Phys. J. C 81 (2021) 4, 293]

(NLO Higgs impact factor) [F. G. C. et al., under review (2022)]

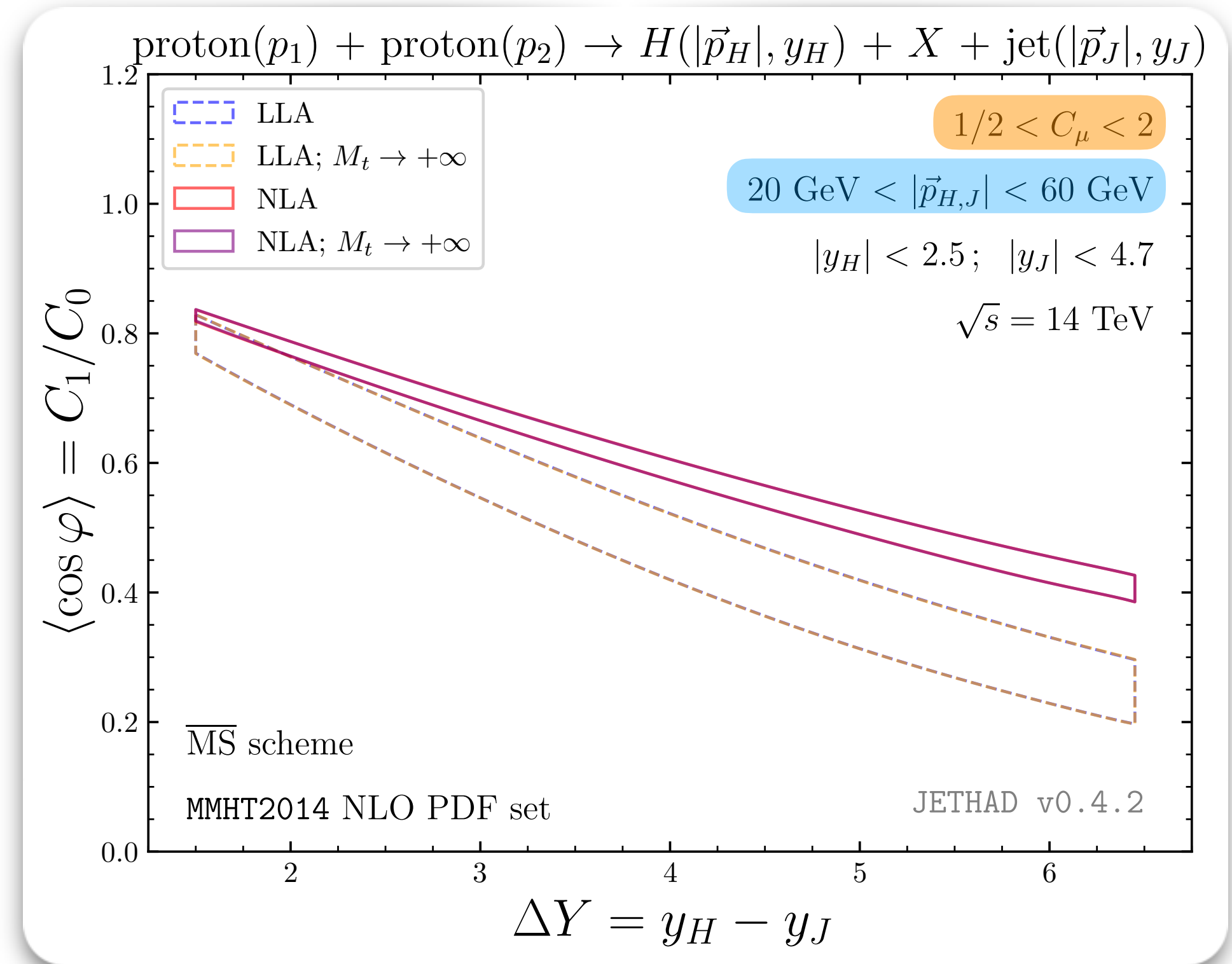

natural scales

symmetric p_T range

Higgs transverse-momentum distribution for $(M_t \rightarrow +\infty)$

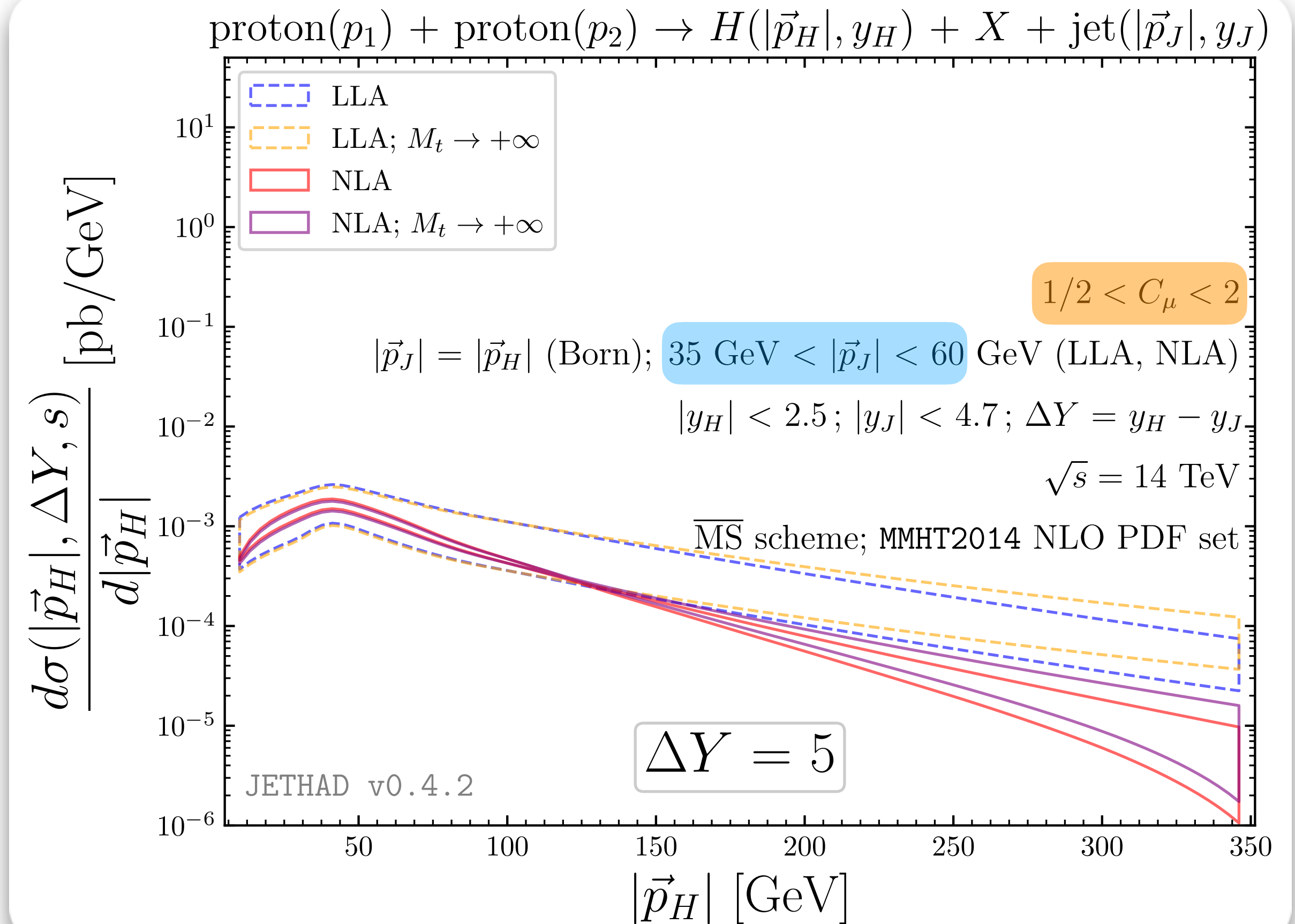
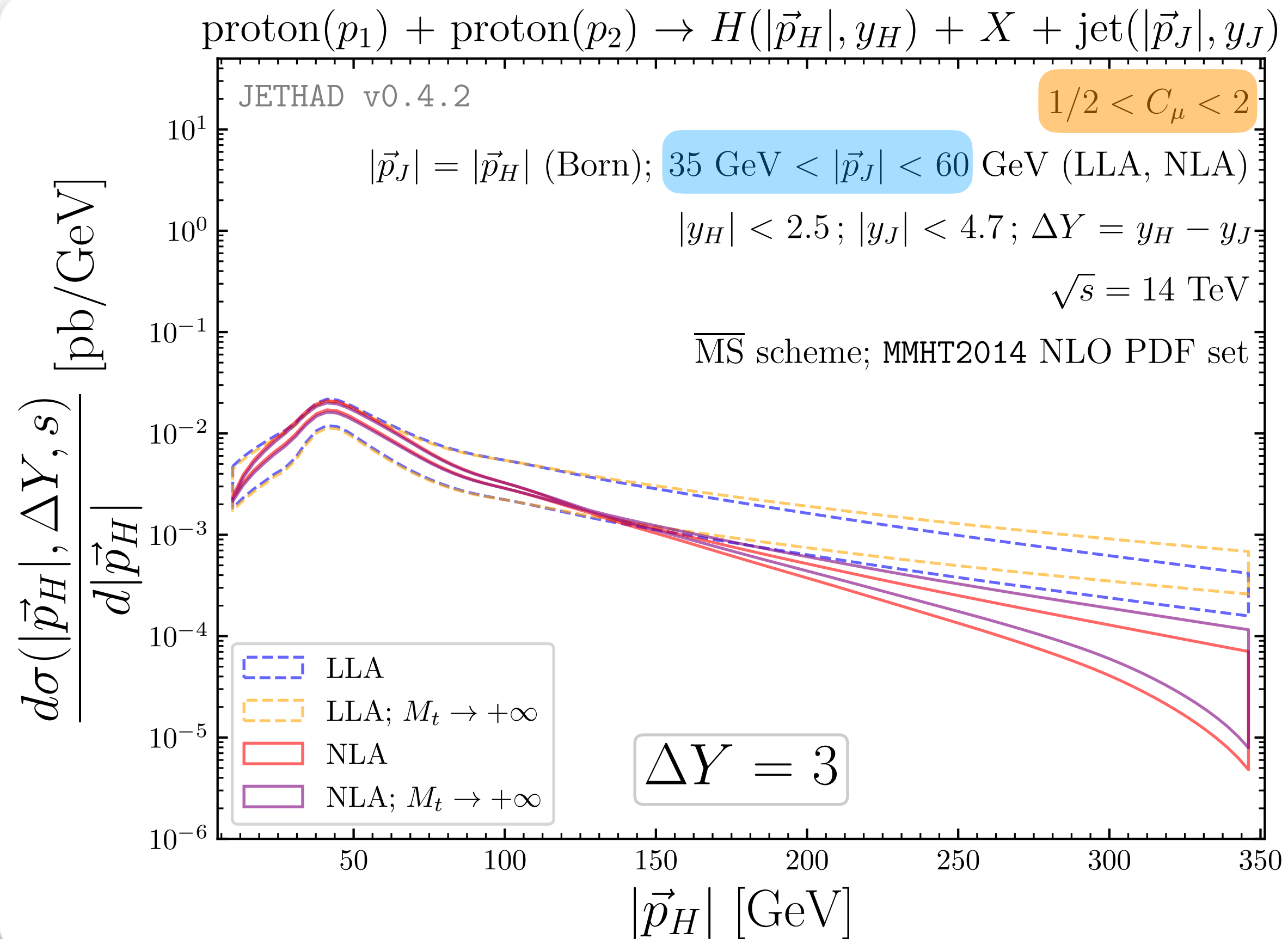

Higgs + jet at @FCC: small- χ enhancement from PDFs

High-energy resummation + NNPDF3.0 [🔗](#)

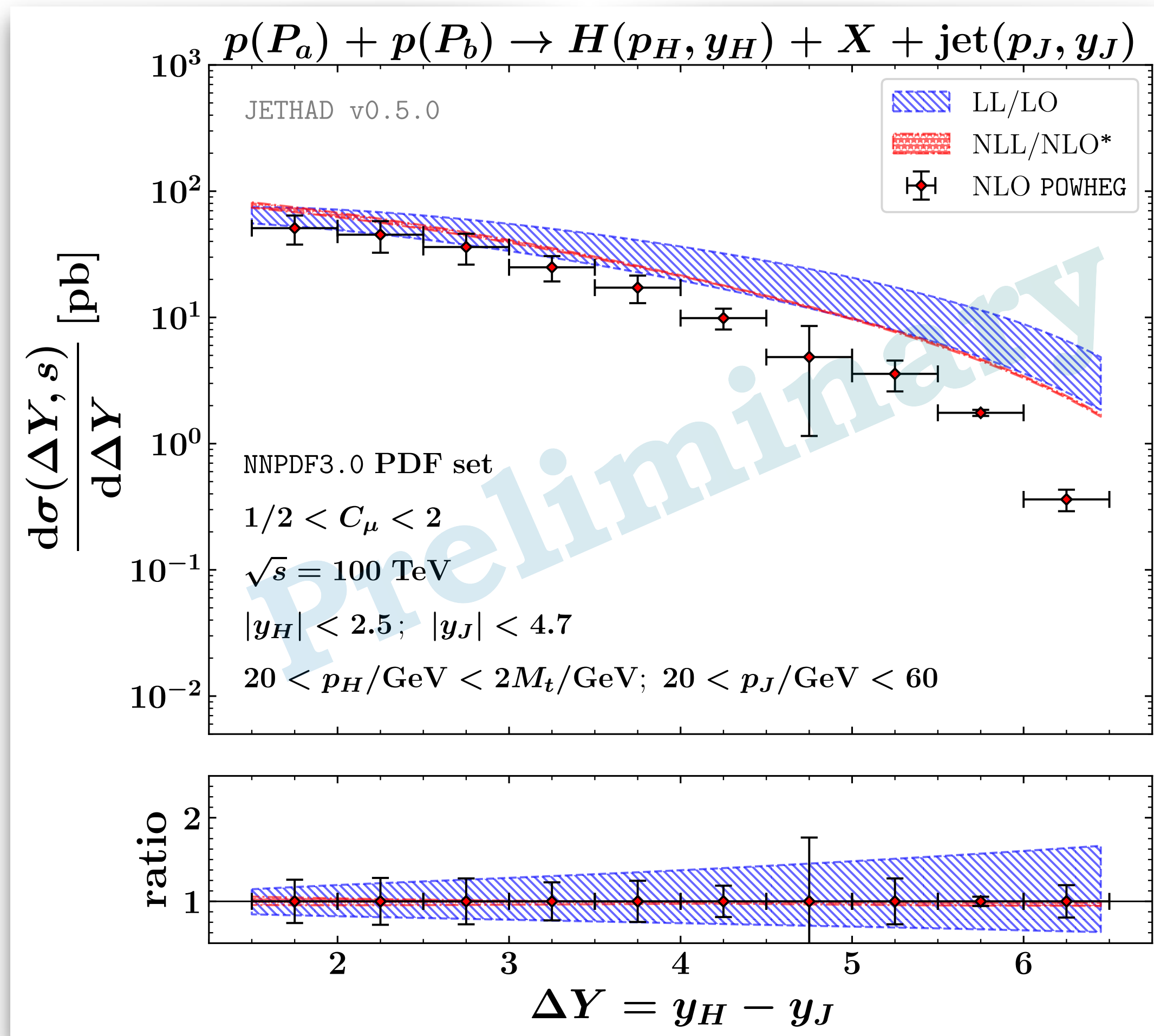

Higgs + jet at @FCC: small- x enhancement from PDFs

High-energy resummation + NNPDF3.0 

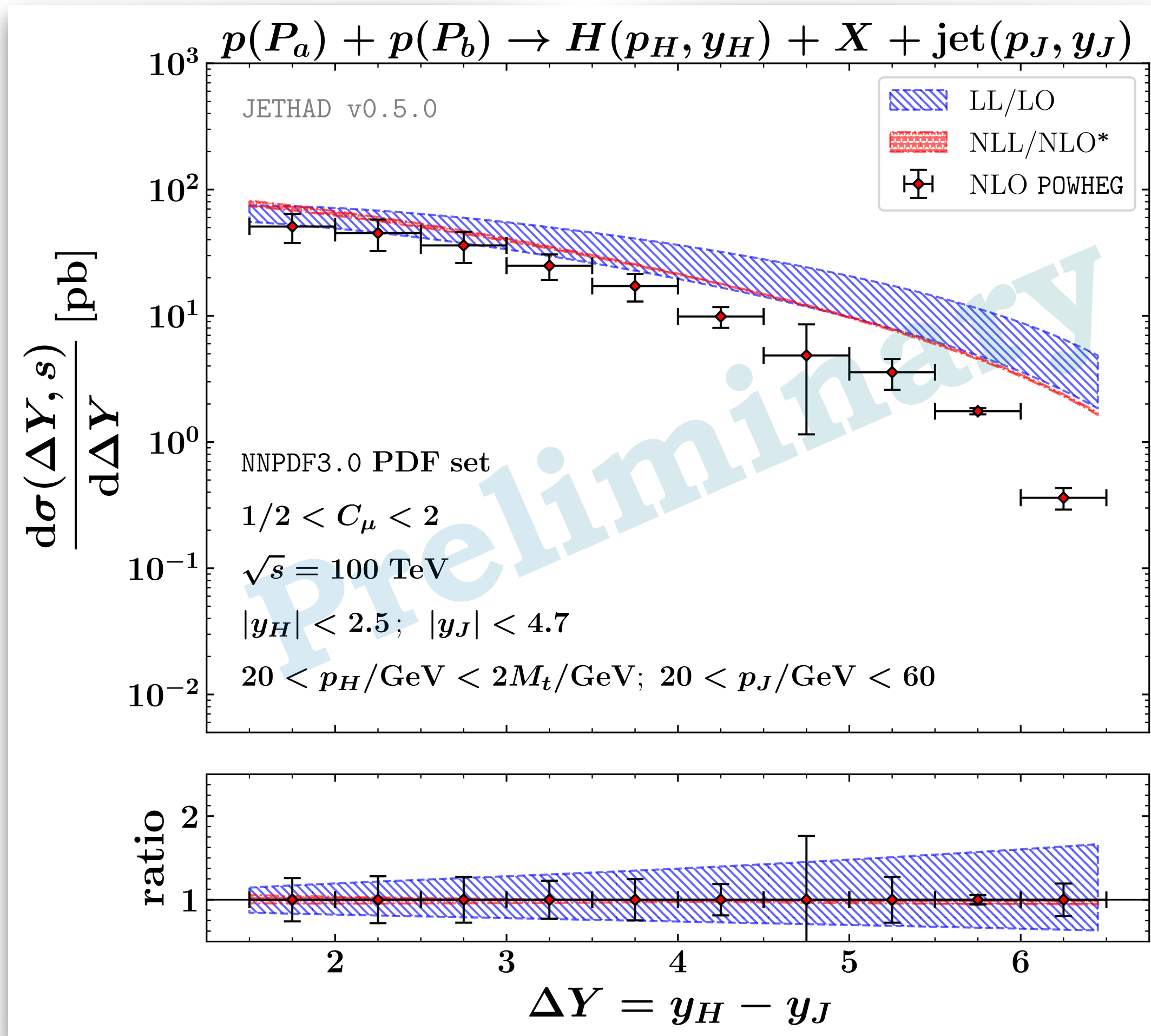

High-energy resummation + NNPDF3.1sx 

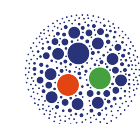
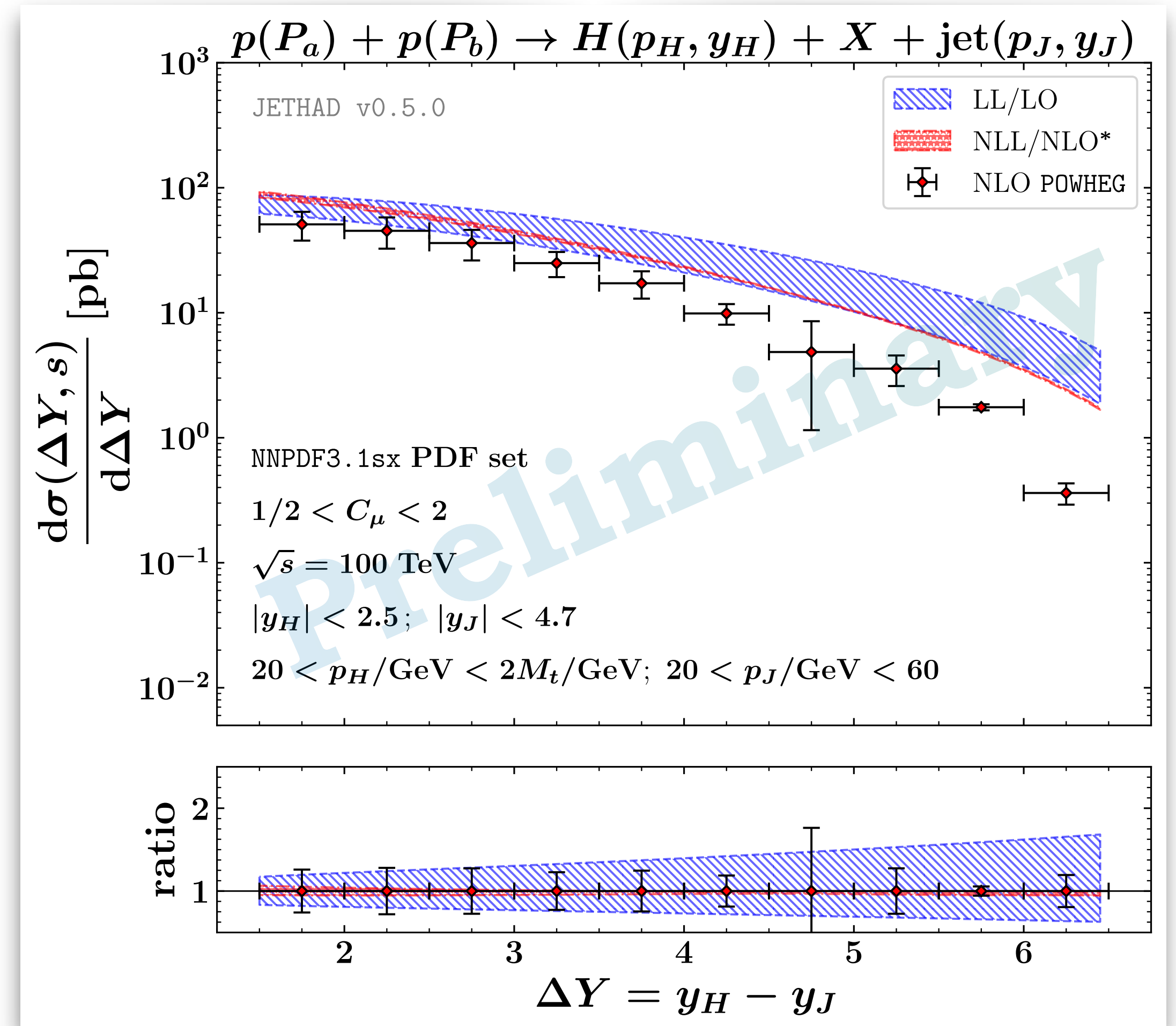

Small- x resummation on PDFs $\Rightarrow + (13.5 \div 2.10) \%$ @NLL/NLO*

Higgs + jet at @FCC: large- x enhancement from PDFs

High-energy resummation + NNPDF3.0 

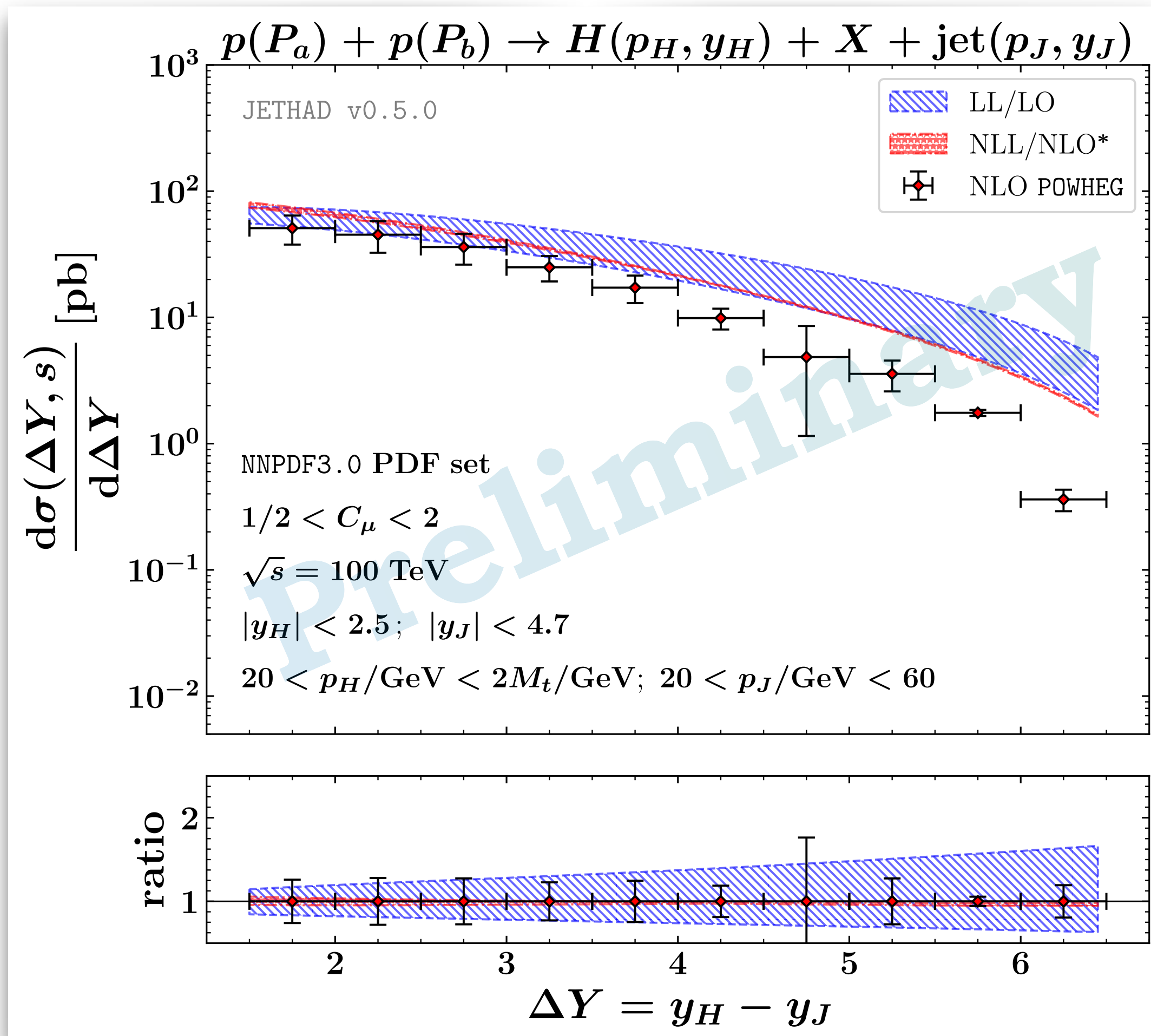

High-energy resummation + NNPDF3.01x 

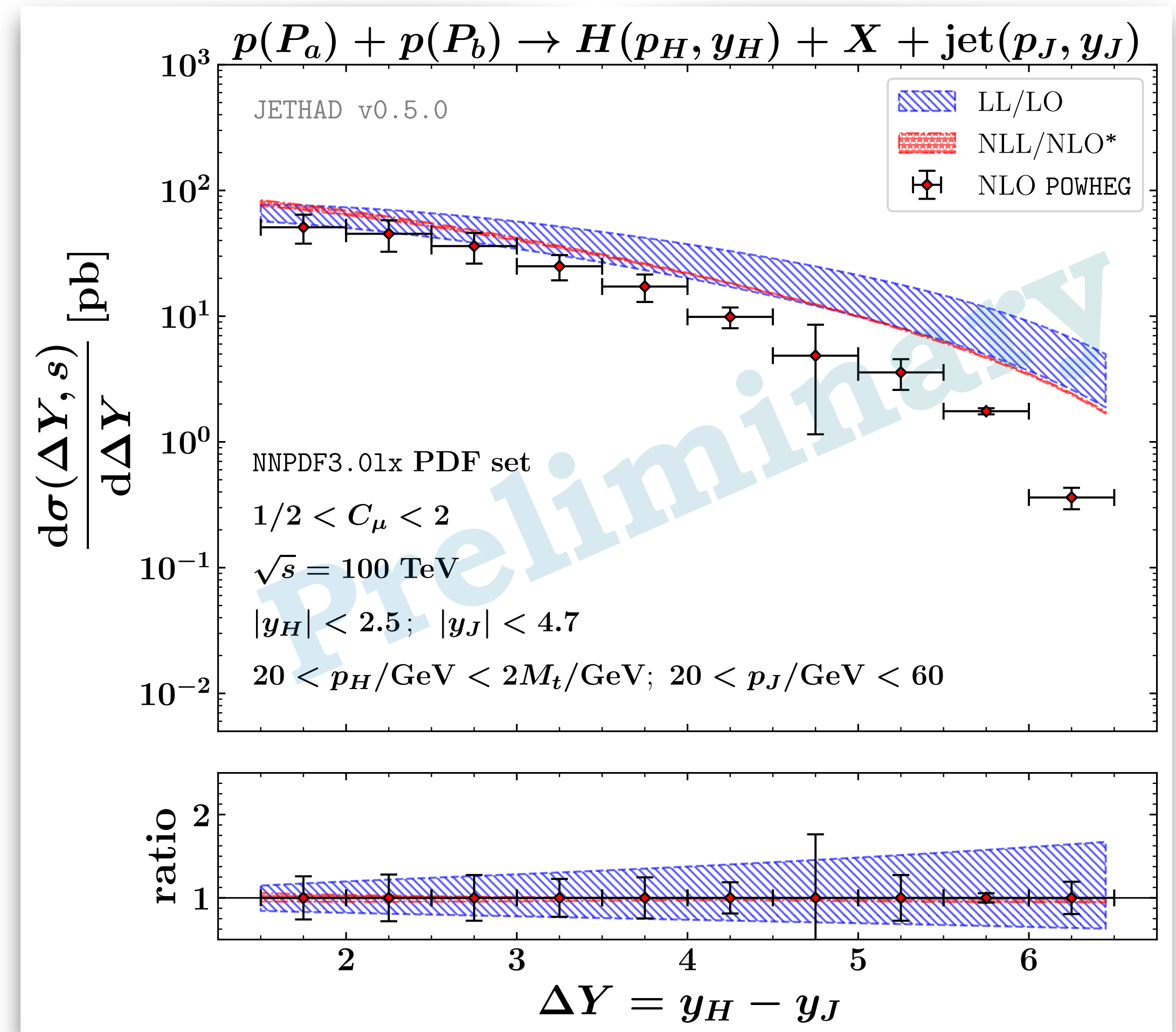

Threshold resummation on PDFs \Rightarrow **+ (10.7 ÷ 2.15) % @NLL/NLO***

HEAVY-LIGHT HADRONS

From Higgs + jet to bound states

Di-hadron and hadron-jet correlations

Inclusive di-hadron production

[D.Yu. Ivanov, A. Papa (2012)] (NLO forward-hadron impact factor)
[F.G.C., D.Yu. Ivanov, B. Murdaca, A. Papa (2016, 2017)]

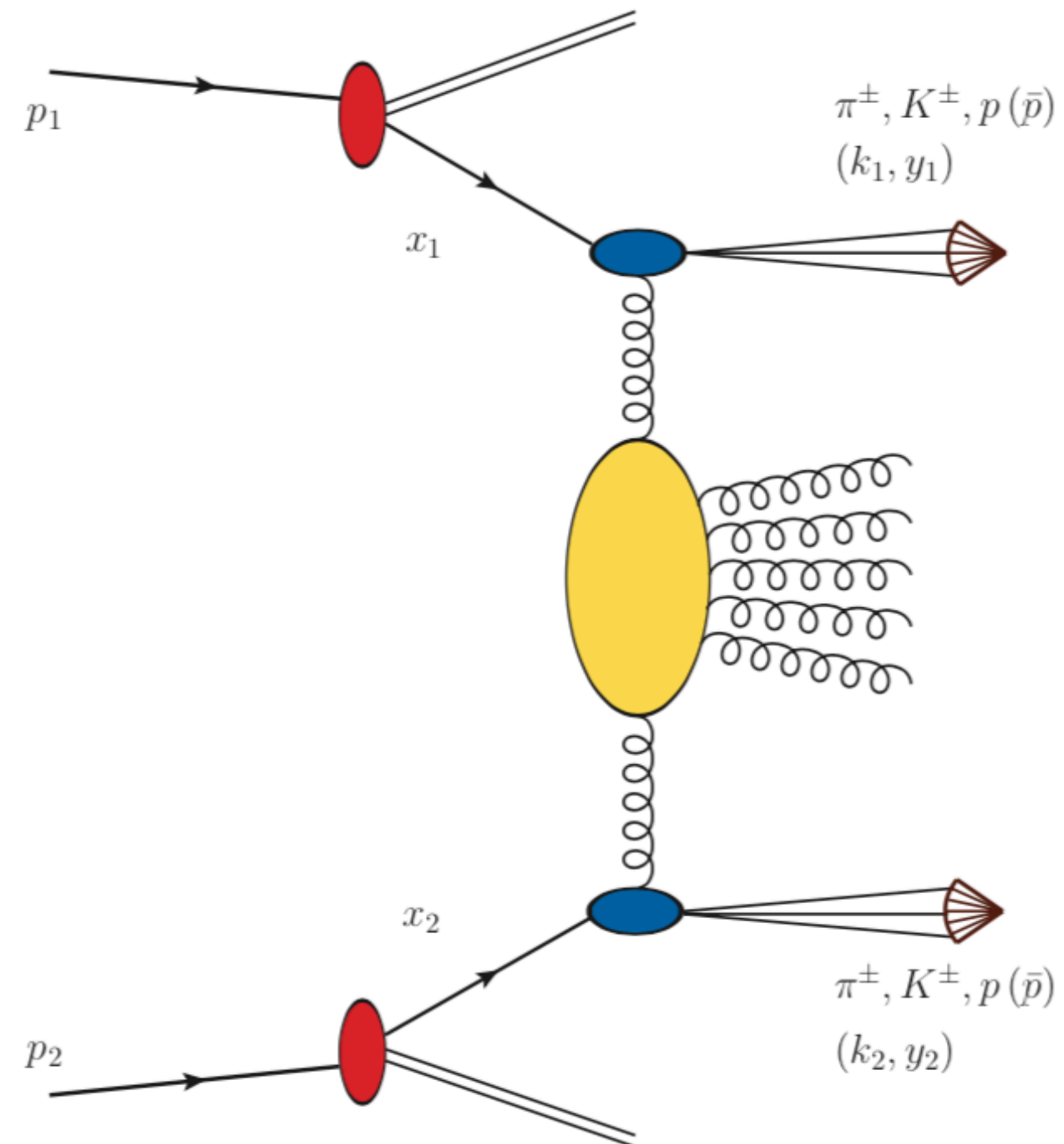

Inclusive hadron-jet production

[A.D. Bolognino, F.G.C., D.Yu. Ivanov, M.M.A. Mohammed, A. Papa (2018)]
[F.G.C. (in preparation)]

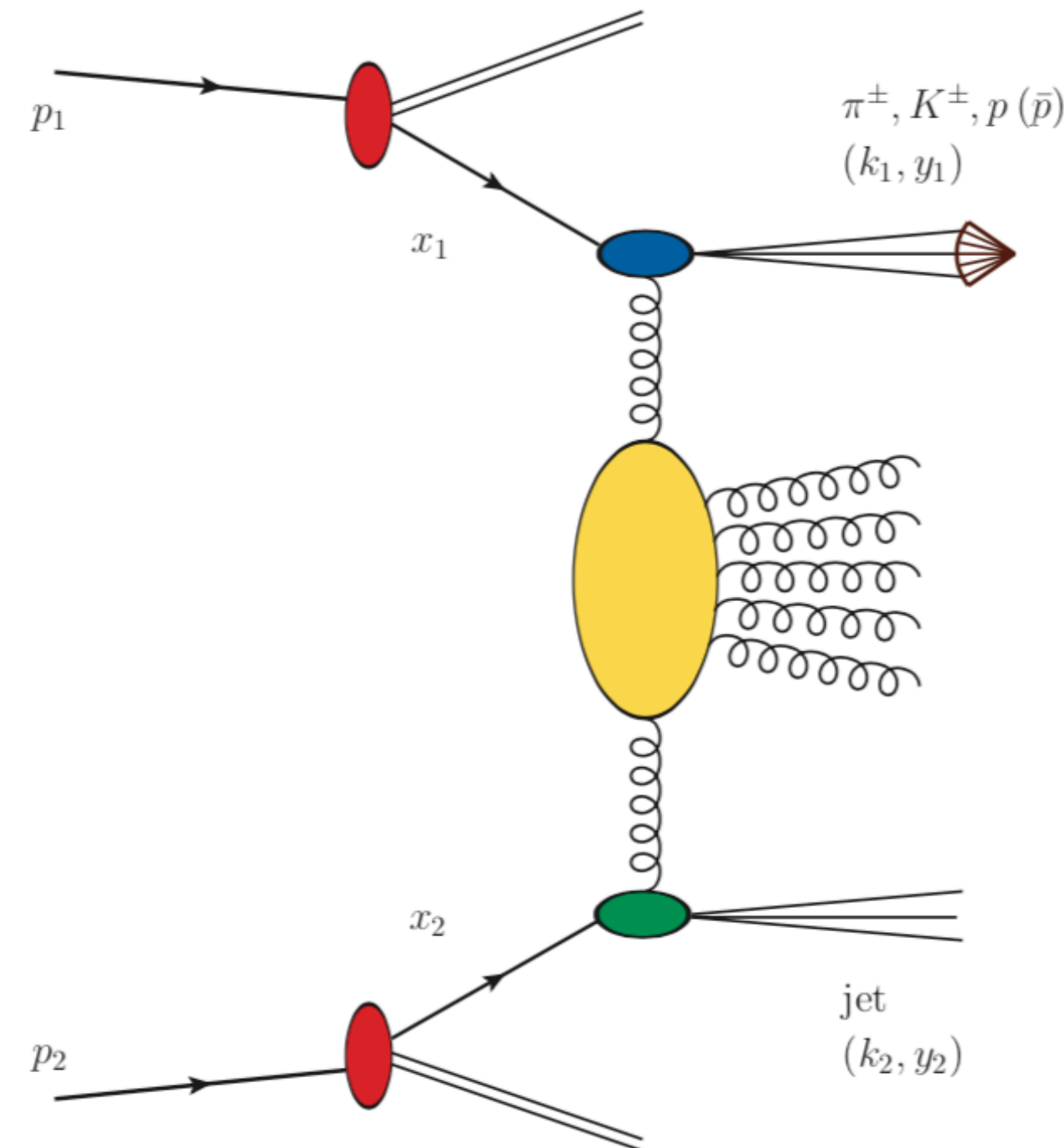

- ◇ NLO impact factors known \Rightarrow full NLA BFKL analysis feasible
- ◇ PDFs + FFs at work (both), hadrons at smaller rapidities than jets (di-hadron)
- ◇ genuine *asymmetric* cuts in transverse momenta (hadron-jet)

Stabilizing effects of heavy-flavor fragmentation



AKK08 VFNS collinear FFs for Λ hyperon: $|uds\rangle$

[\[S. Albino et al., Nucl. Phys. B 803 \(2008\) 42-104\]](#)

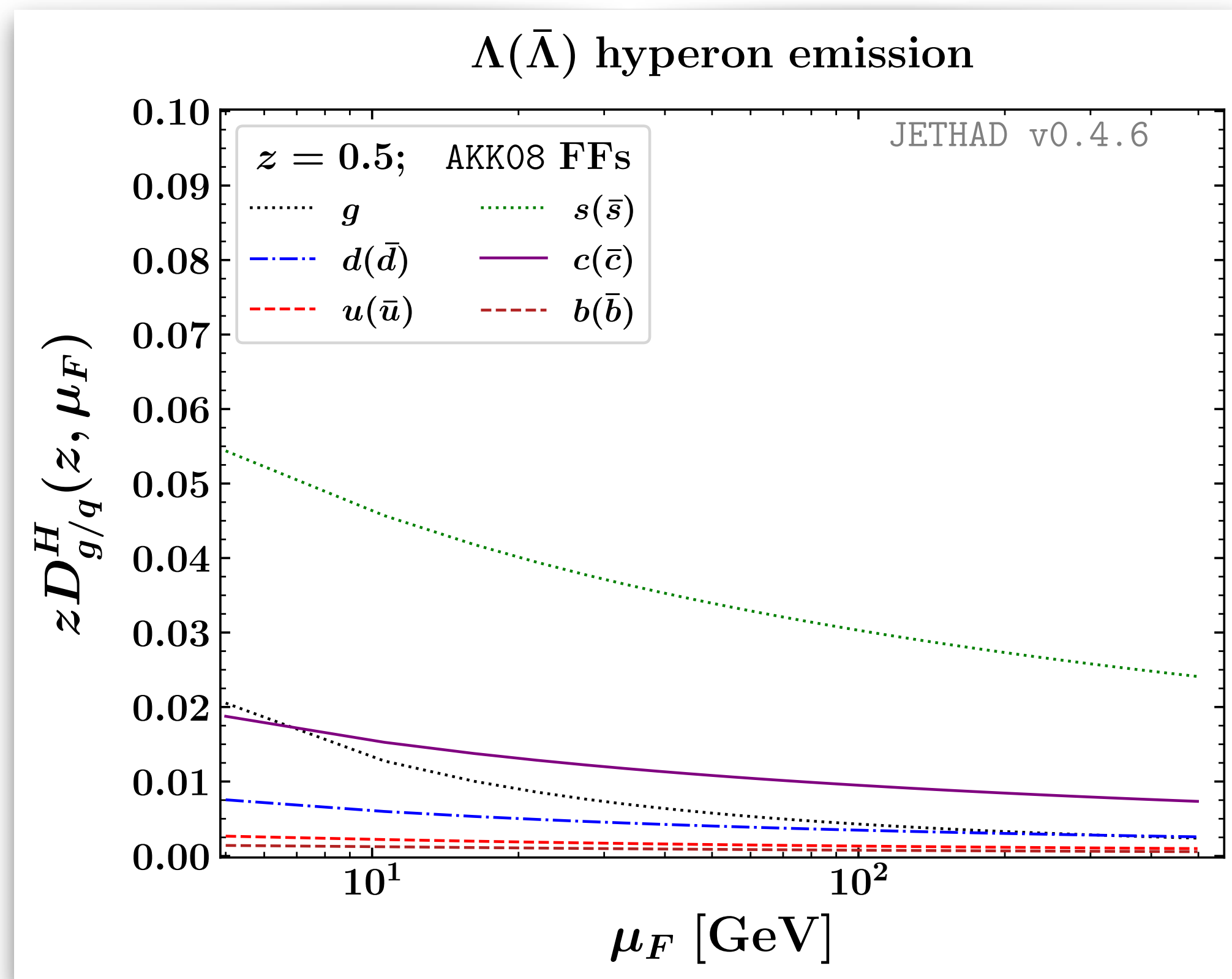

Stabilizing effects of heavy-flavor fragmentation

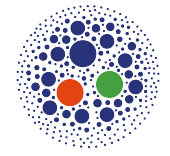

AKK08 VFNS collinear FFs for Λ hyperon: $|uds\rangle$

[S. Albino et al., Nucl. Phys. B 803 (2008) 42-104]

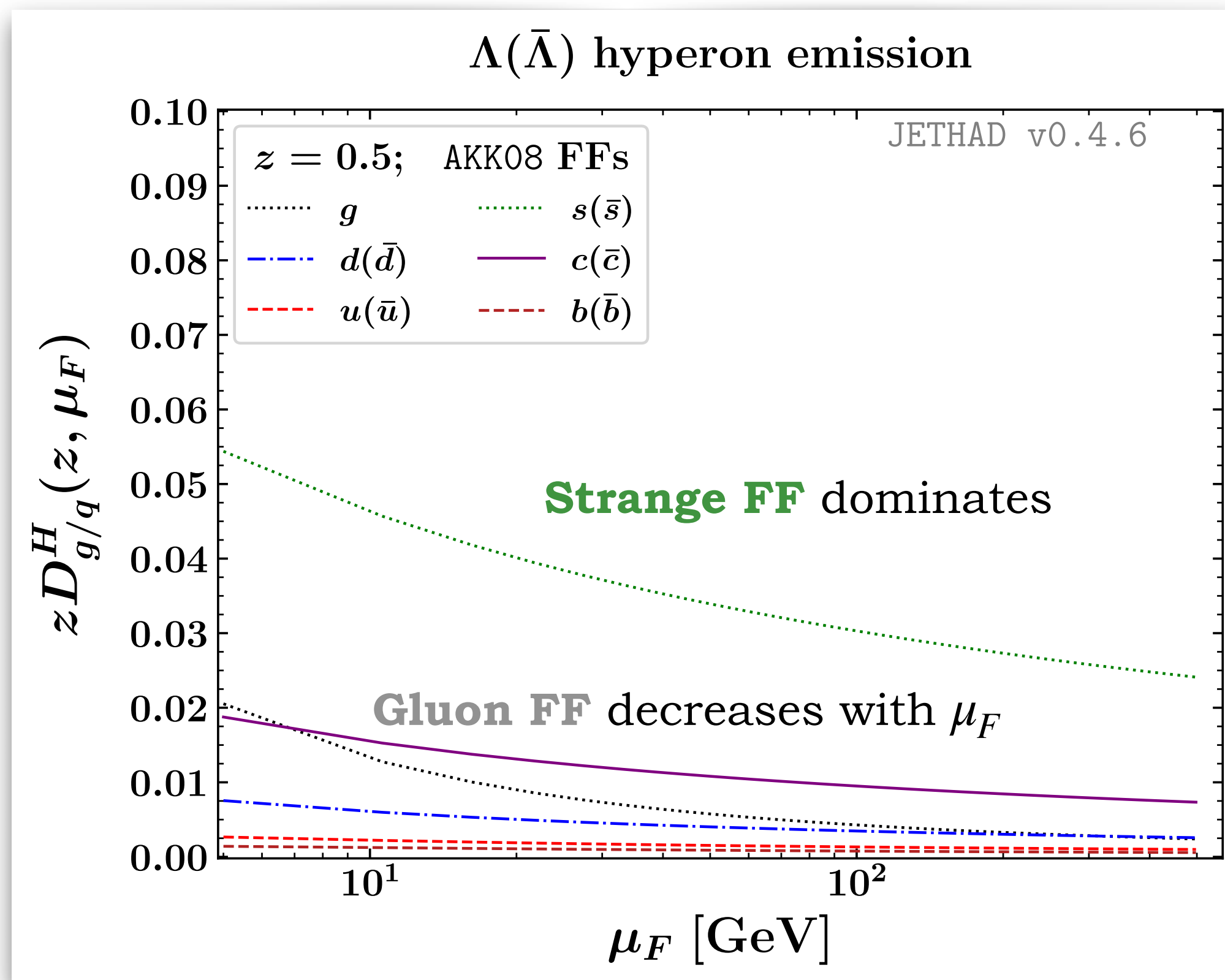

Stabilizing effects of heavy-flavor fragmentation

 **AKK08** VFNS collinear FFs for Λ hyperon: $|uds\rangle$

 [S. Albino et al., Nucl. Phys. B 803 (2008) 42-104]

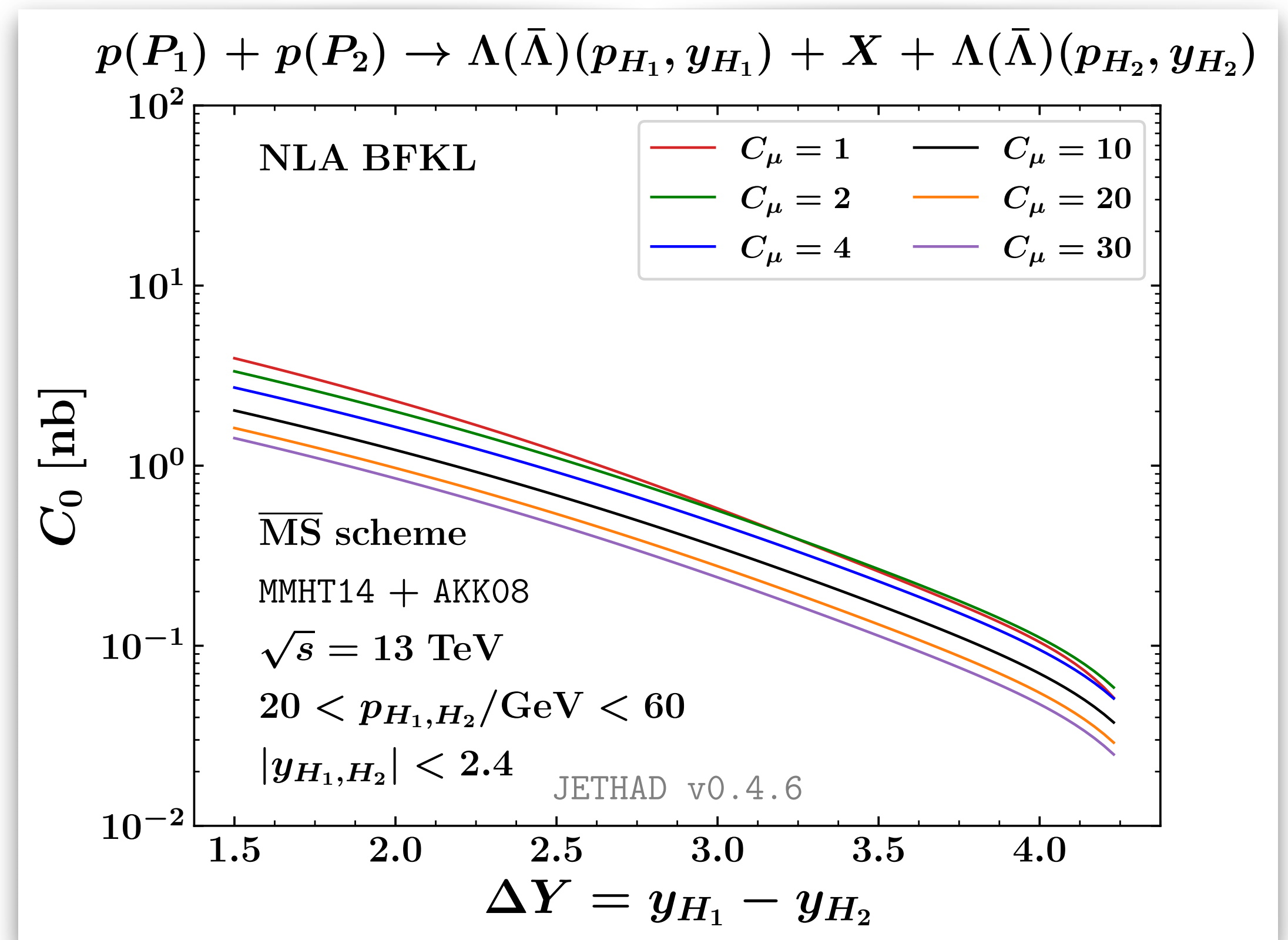
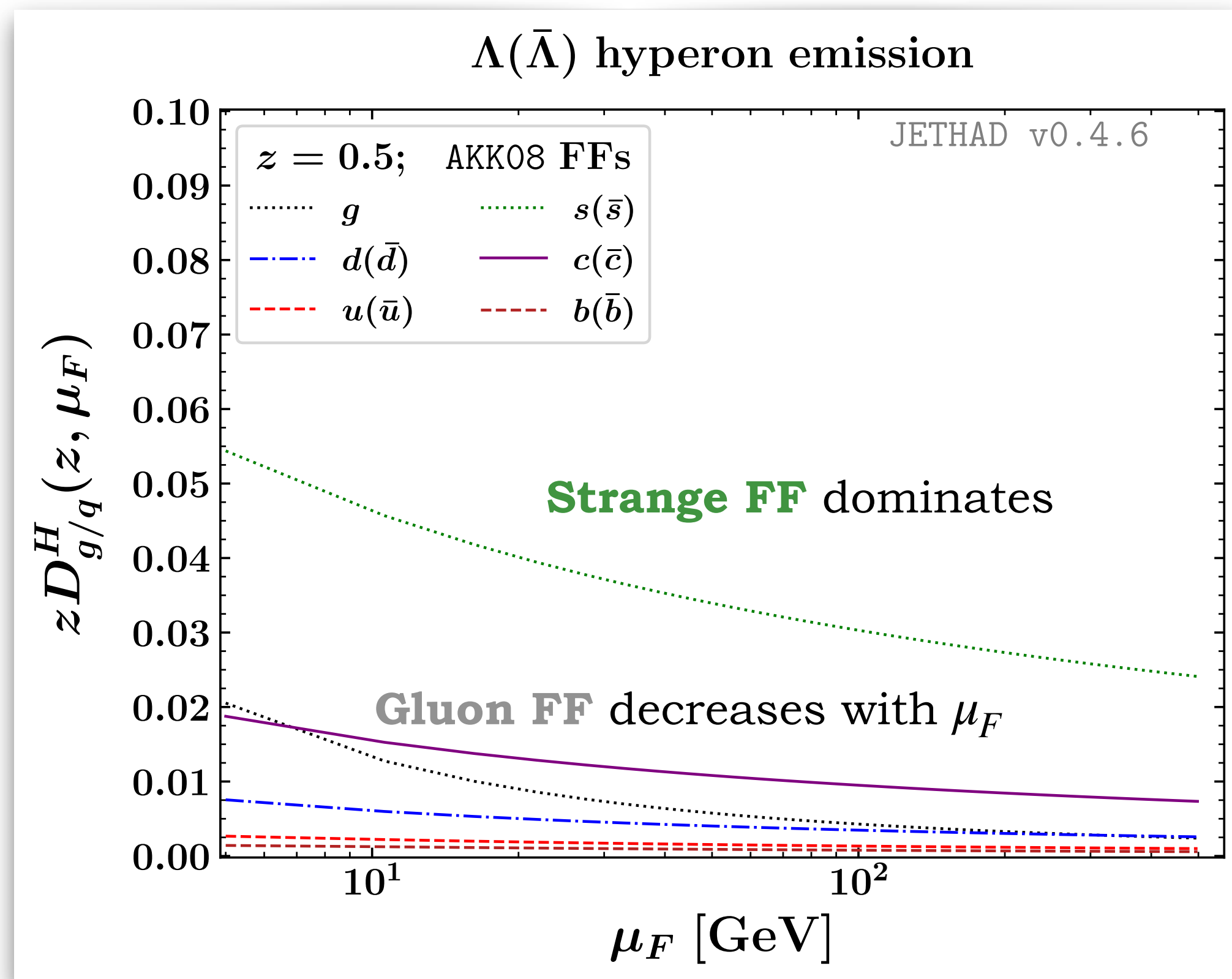

 Rapidity distribution **sensitive** to scale variations

(Λ hyperons)  [F. G. C. et al., Phys. Rev. D 102 (2020) 9, 094019]

(cascade Ξ baryons)  [F. G. C., Eur. Phys. J. C (in press)]

Stabilizing effects of heavy-flavor fragmentation

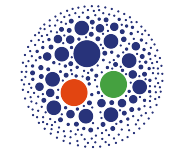

KKSS19 VFNS collinear FFs for Λ_c baryons: $|udc\rangle$

[\[B. A. Kniehl et al., Phys. Rev. D 101 \(2020\) 11, 114021\]](#)

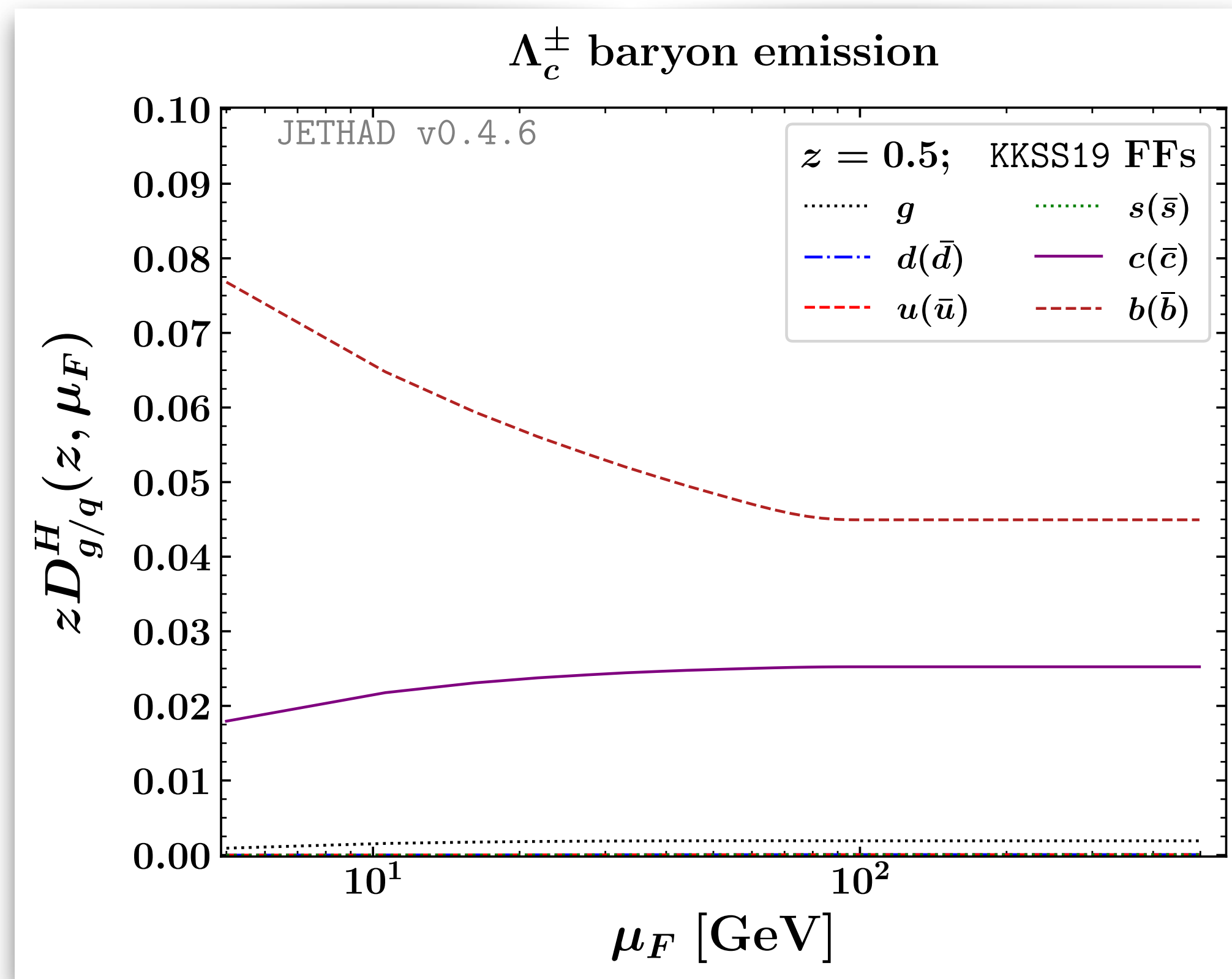

Stabilizing effects of heavy-flavor fragmentation

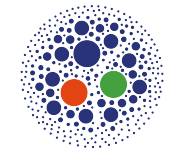

KKSS19 VFNS collinear FFs for Λ_c baryons: $|udc\rangle$

[\[B. A. Kniehl et al., Phys. Rev. D 101 \(2020\) 11, 114021\]](#)

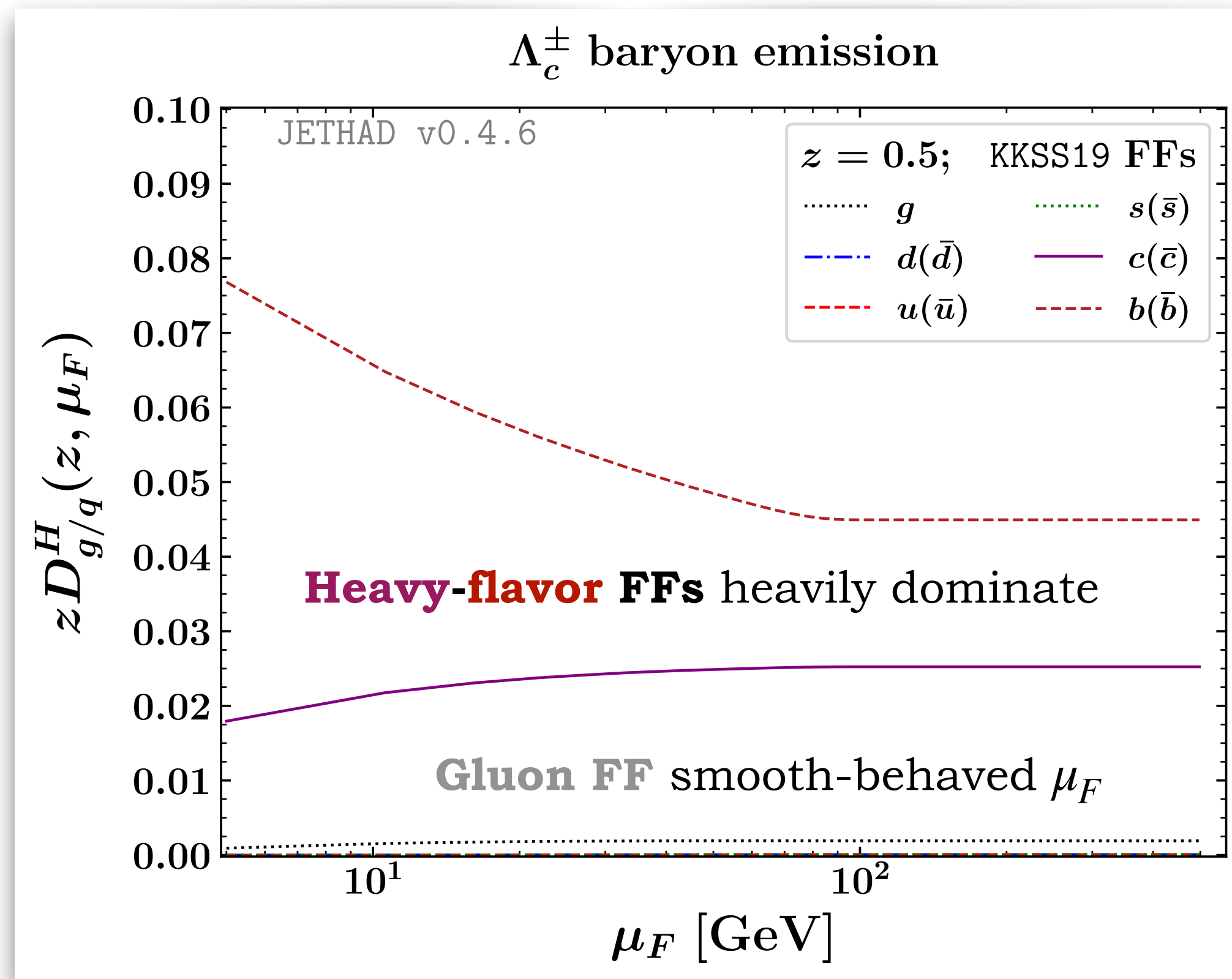

Stabilizing effects of heavy-flavor fragmentation

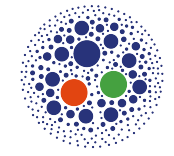

KKSS19 VFNS collinear FFs for Λ_c baryons: $|udc\rangle$

[B. A. Kniehl et al., Phys. Rev. D 101 (2020) 11, 114021]

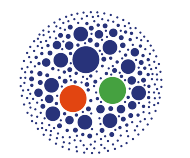
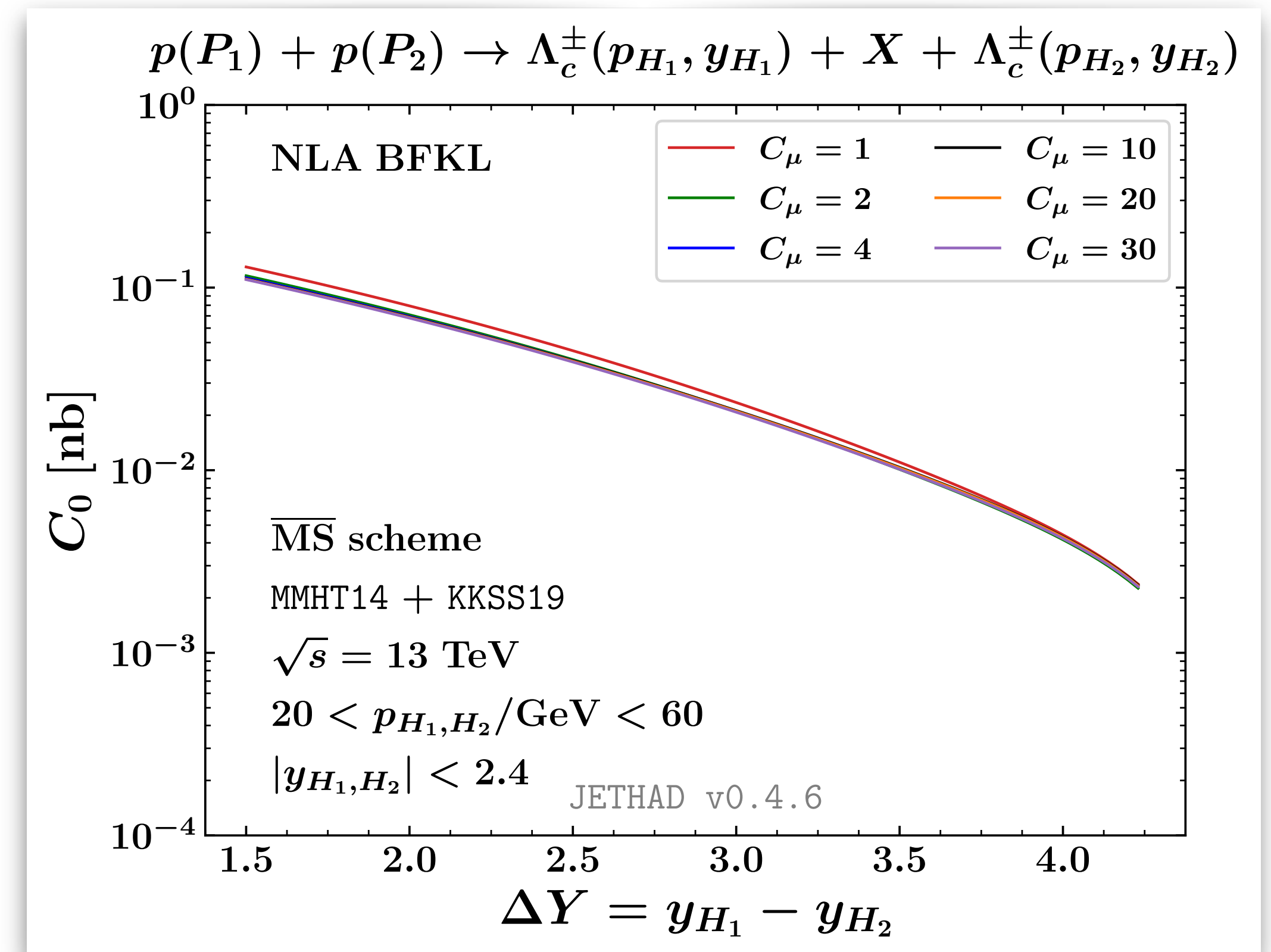
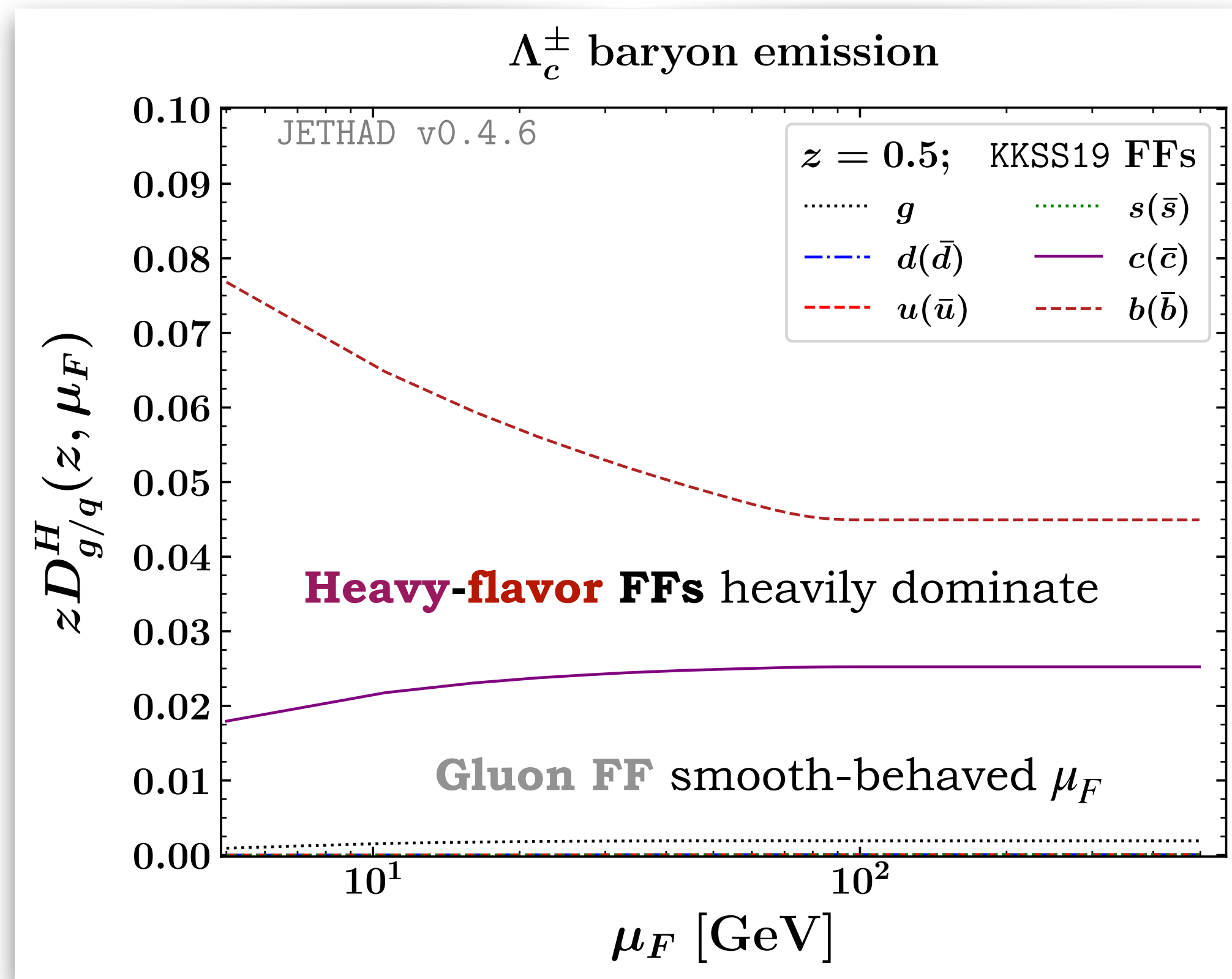

Rapidity distribution **stable** under scale variations

($B_c^{(*)}$ hadrons) [F. G. C., Phys. Lett. B 835 (2022) 137554]

(Λ_c baryons, in this slide) [F. G. C. et al., Eur. Phys. J. C 81 (2021) 8, 780]

(H_b hadrons) [F. G. C. et al., Phys. Rev. D 104 (2021) 11, 114007]

Stability under scale variations & NLL corrections

Hybrid factorization @work: Λ_c baryons $|udc\rangle$ versus Λ hyperons $|uds\rangle$

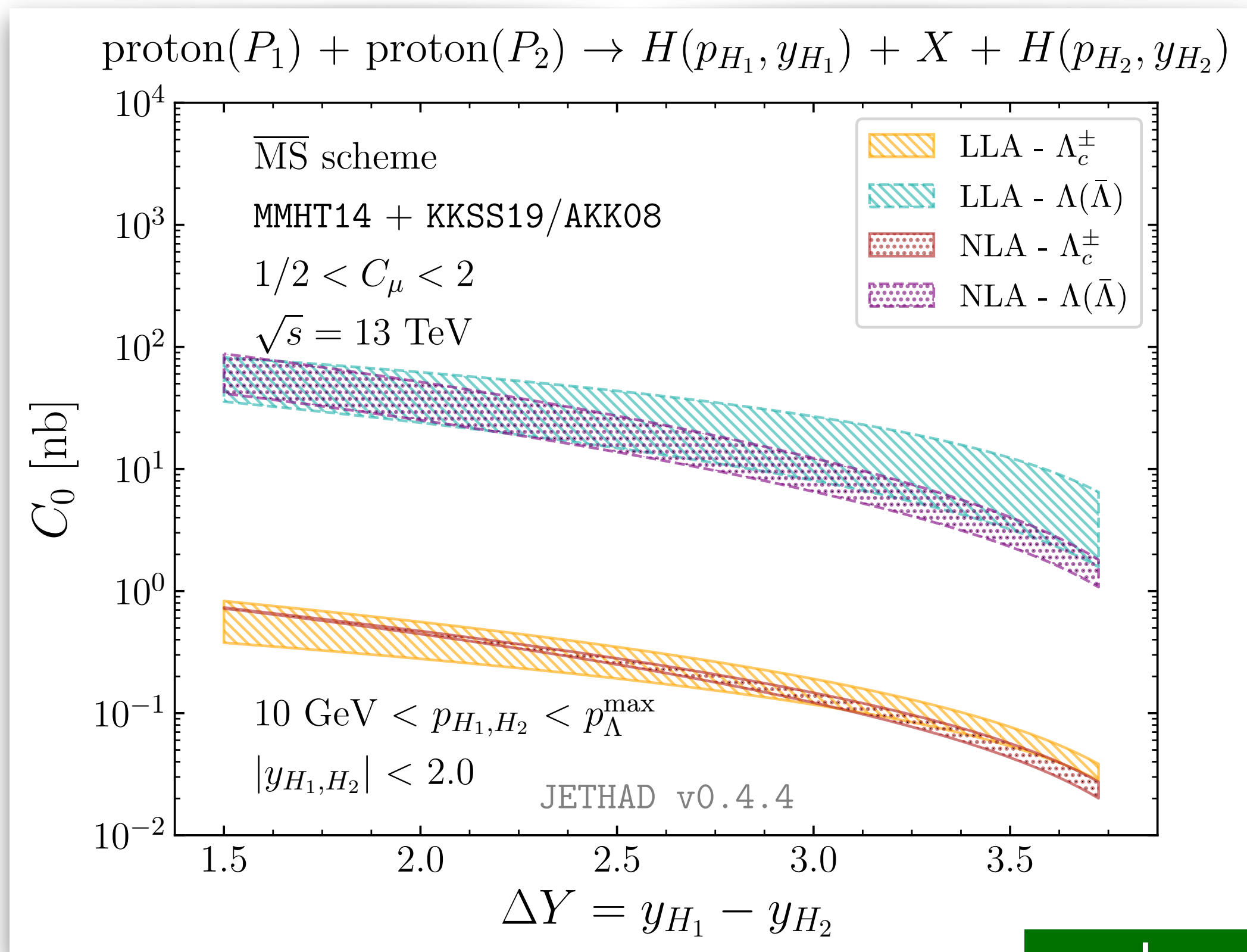

natural

Stability under scale variations & NLL corrections

Hybrid factorization @work: Λ_c baryons $|udc\rangle$ versus Λ hyperons $|uds\rangle$

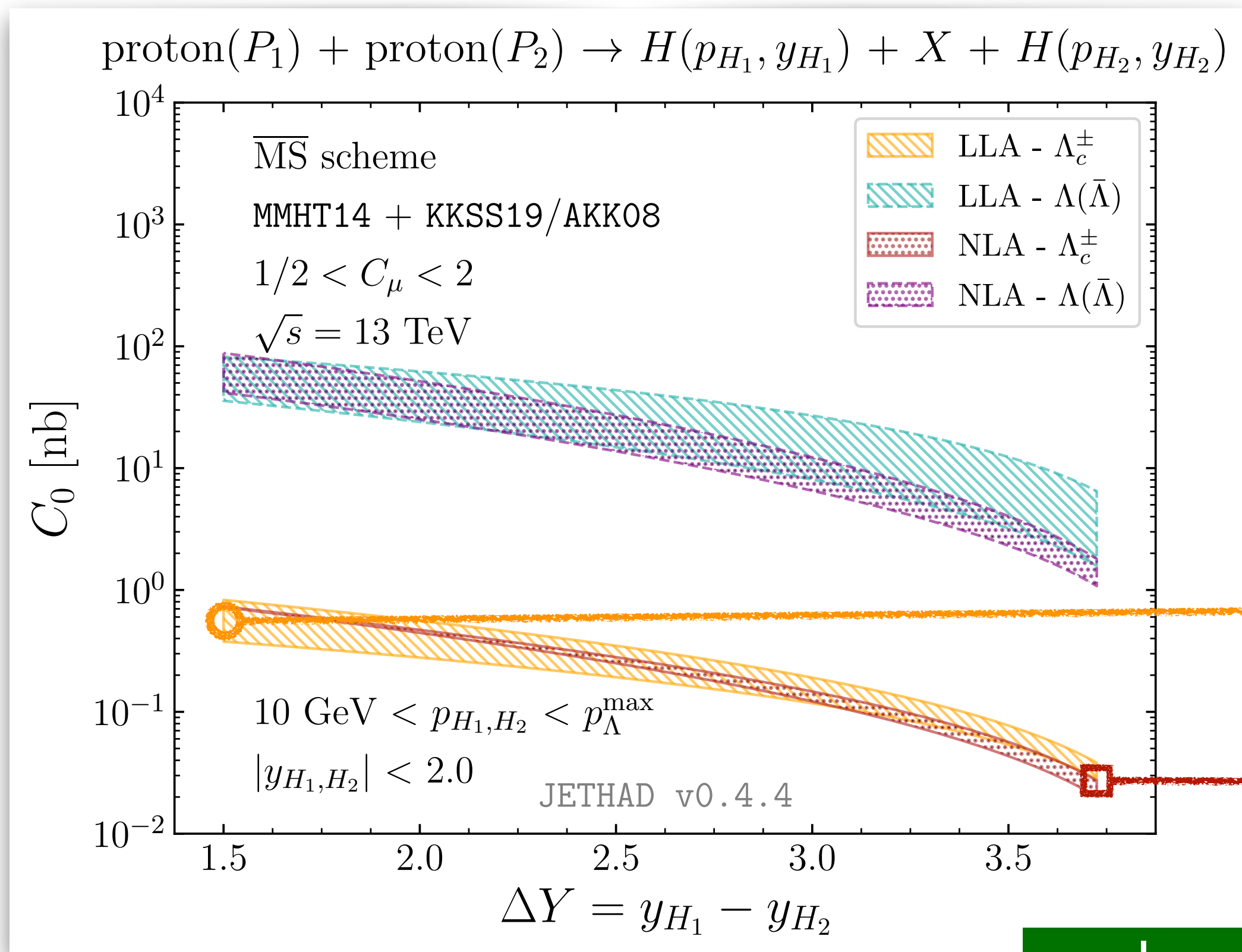

LL Λ_c

NLL Λ_c

natural

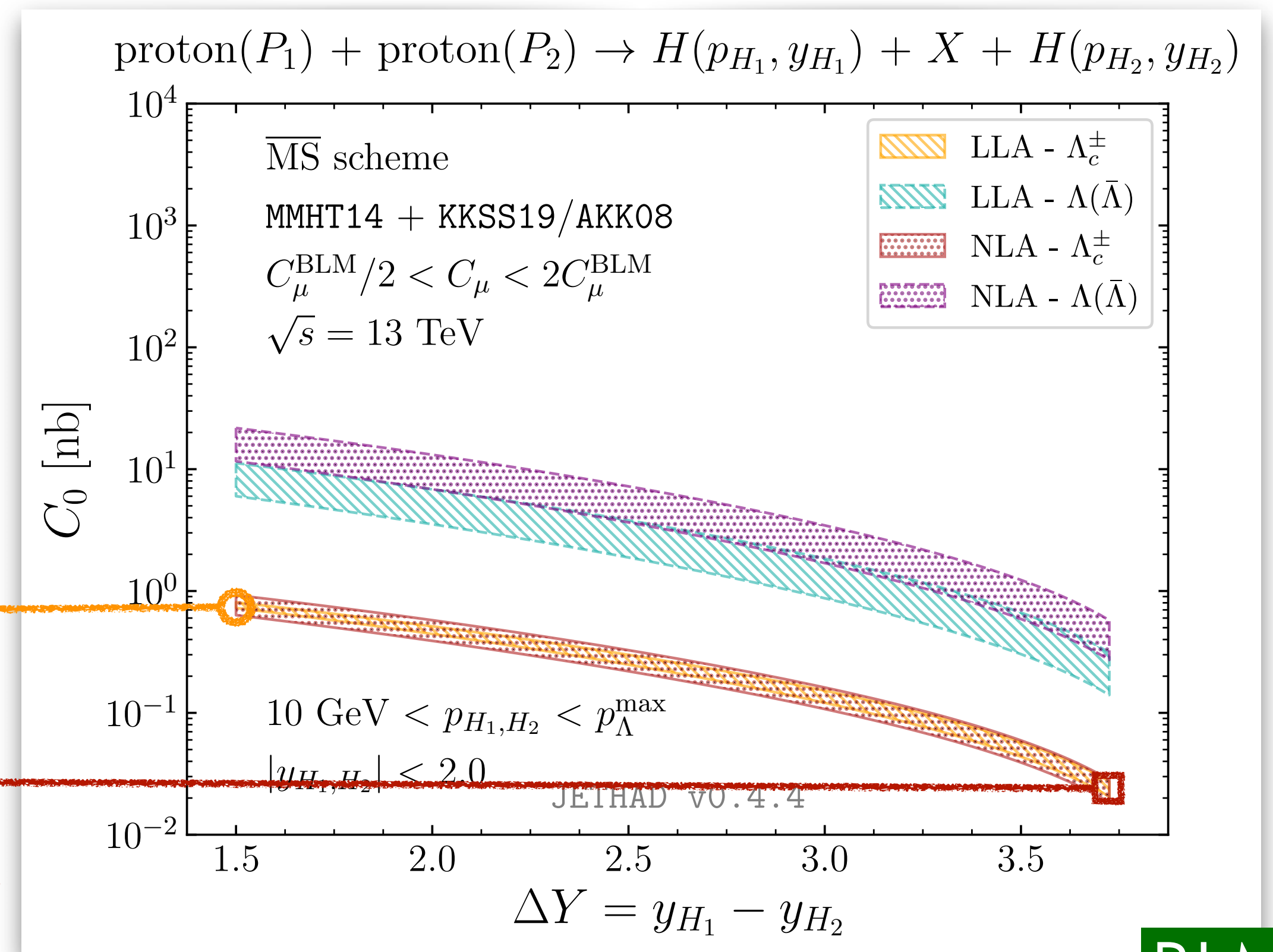

BLM

NLL corrections: rapidity distribution **stable** for Λ_c

(Λ_c baryons, in this slide) [\[F. G. C. et al., Eur. Phys. J. C 81 \(2021\) 8, 780\]](#)

(H_b hadrons) [\[F. G. C. et al., Phys. Rev. D 104 \(2021\) 11, 114007\]](#)

Backup

Stability under scale variations & NLL corrections

Hybrid factorization @work: Λ_c baryons $|udc\rangle$ versus Λ hyperons $|uds\rangle$

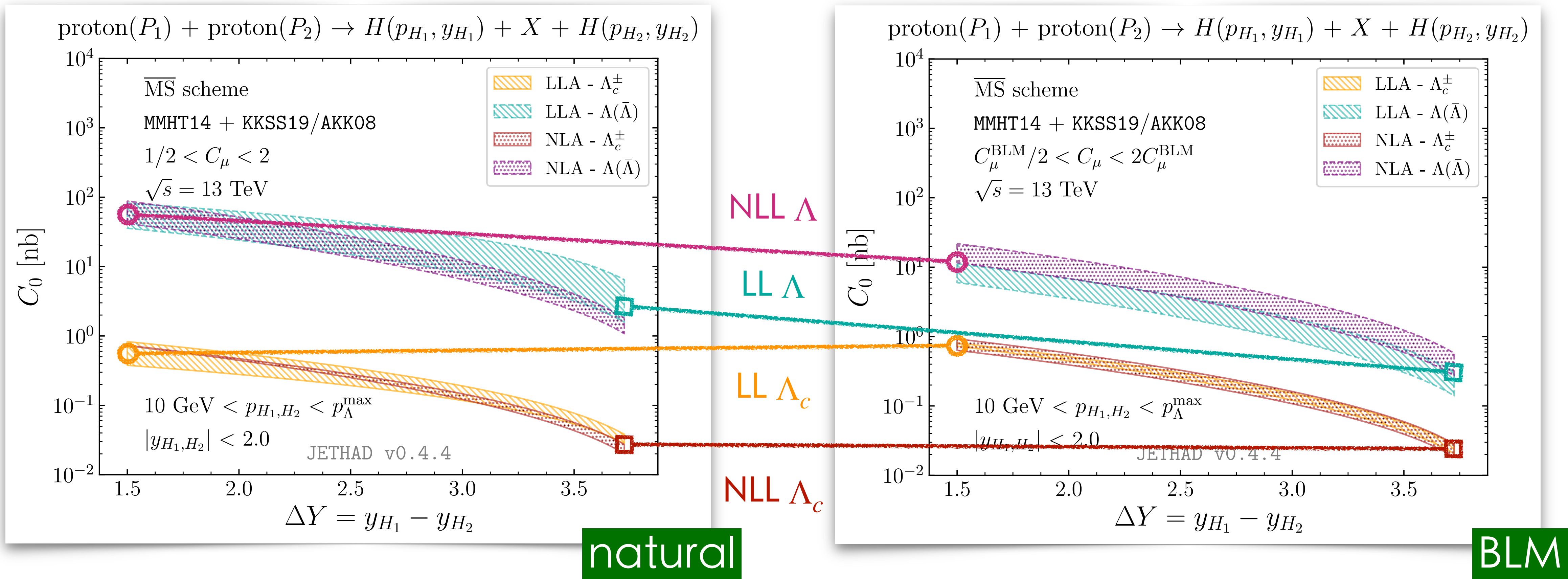

NLL corrections: rapidity distribution **stable** for Λ_c , loses $\sim 10^1$ magnitude for Λ

(Λ_c baryons, in this slide) [\[F. G. C. et al., Eur. Phys. J. C 81 \(2021\) 8, 780\]](#)

(H_b hadrons) [\[F. G. C. et al., Phys. Rev. D 104 \(2021\) 11, 114007\]](#)

Stabilizing effects of heavy-flavor fragmentation

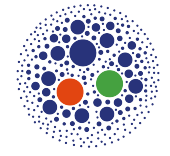

KKSS07 VFNS collinear FFs for:

$$H_b = B^\pm, B^0, B_s^0, \Lambda_b$$

[\[B. A. Kniehl, H. Spiesberger, Phys. Rev. D 98 \(2018\) 11, 114010\]](#)

[\[B. A. Kniehl et al., Phys. Rev. D 77 \(2008\) 11, 014011\]](#)

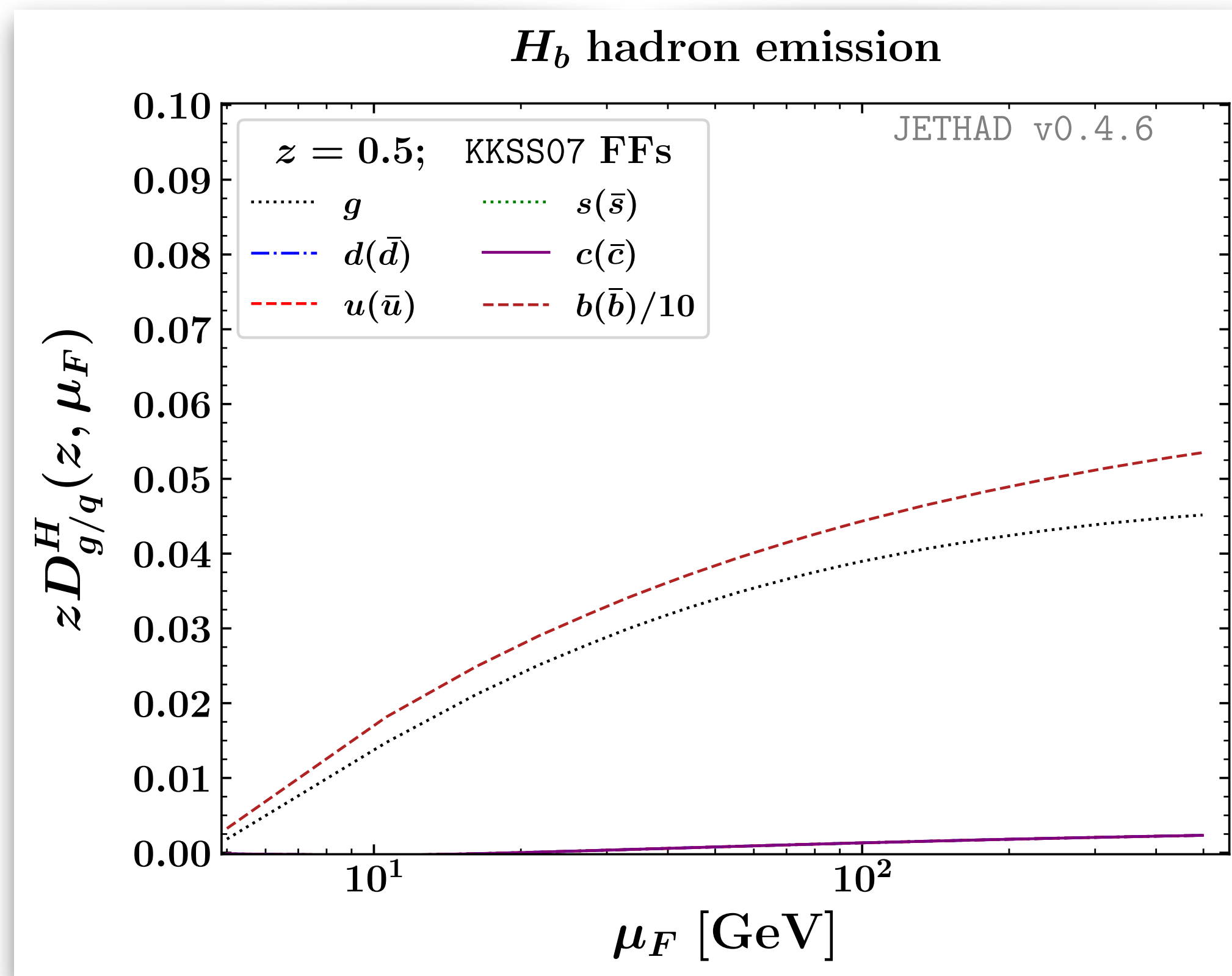

Stabilizing effects of heavy-flavor fragmentation

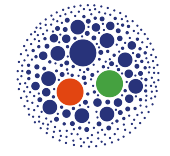

KKSS07 VFNS collinear FFs for:

$$H_b = B^\pm, B^0, B_s^0, \Lambda_b$$

[\[B. A. Kniehl, H. Spiesberger, Phys. Rev. D 98 \(2018\) 11, 114010\]](#)

[\[B. A. Kniehl et al., Phys. Rev. D 77 \(2008\) 11, 014011\]](#)

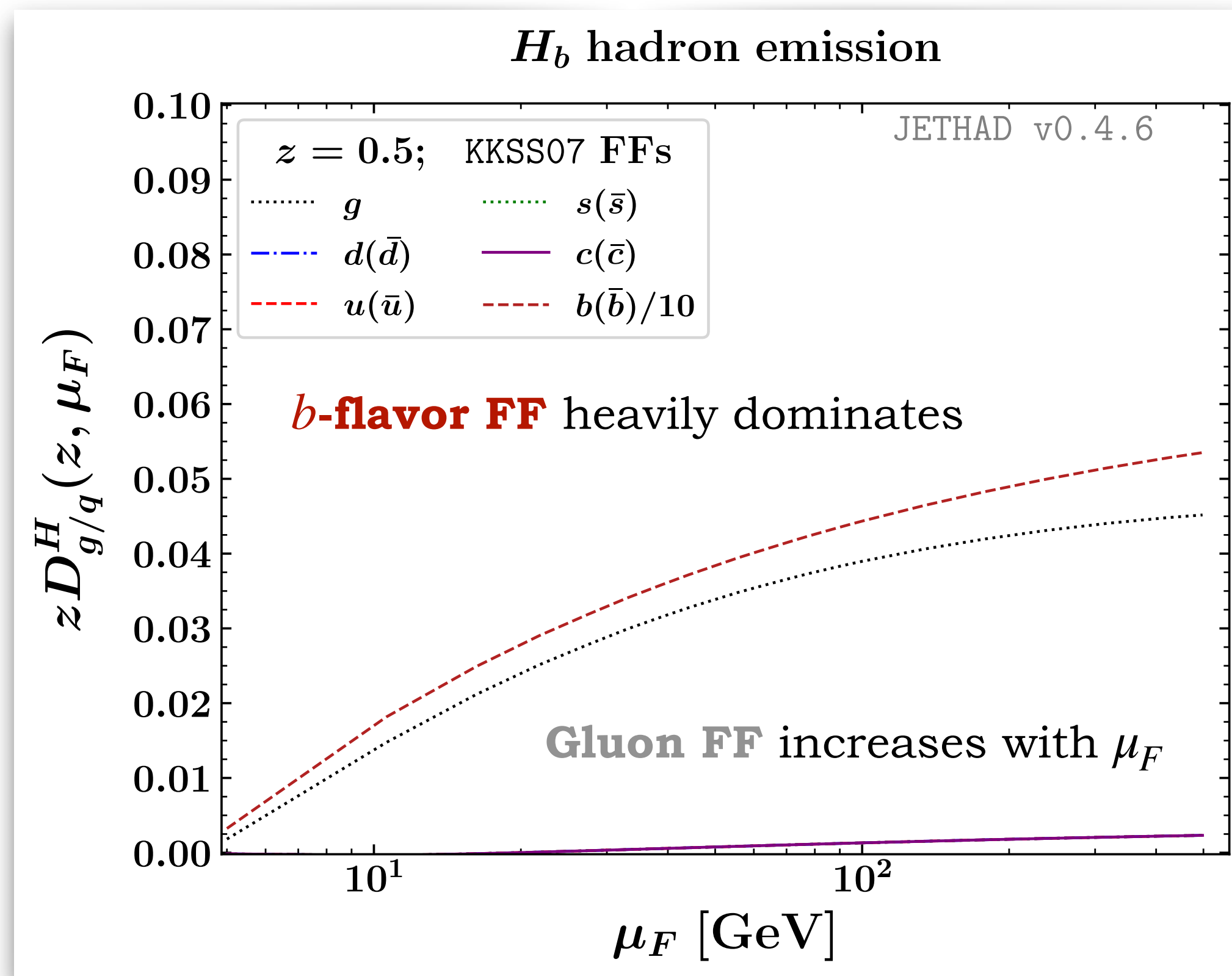

Stabilizing effects of heavy-flavor fragmentation

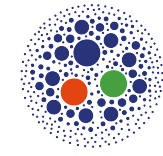

KKSS07 VFNS collinear FFs for:

$$H_b = B^\pm, B^0, B_s^0, \Lambda_b$$

[\[B. A. Kniehl, H. Spiesberger, Phys. Rev. D 98 \(2018\) 11, 114010\]](#)

[\[B. A. Kniehl et al., Phys. Rev. D 77 \(2008\) 11, 014011\]](#)

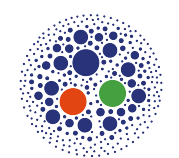
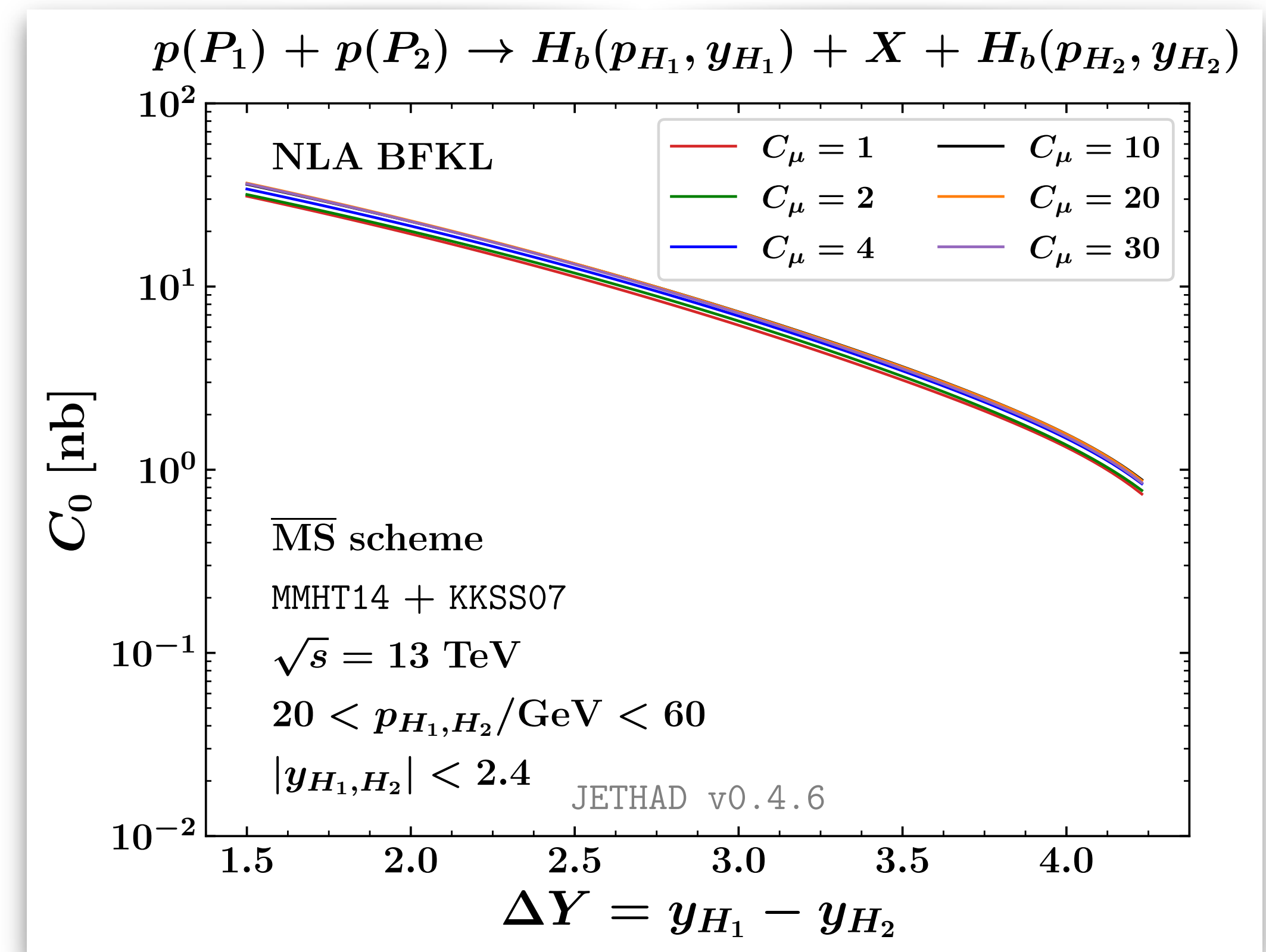
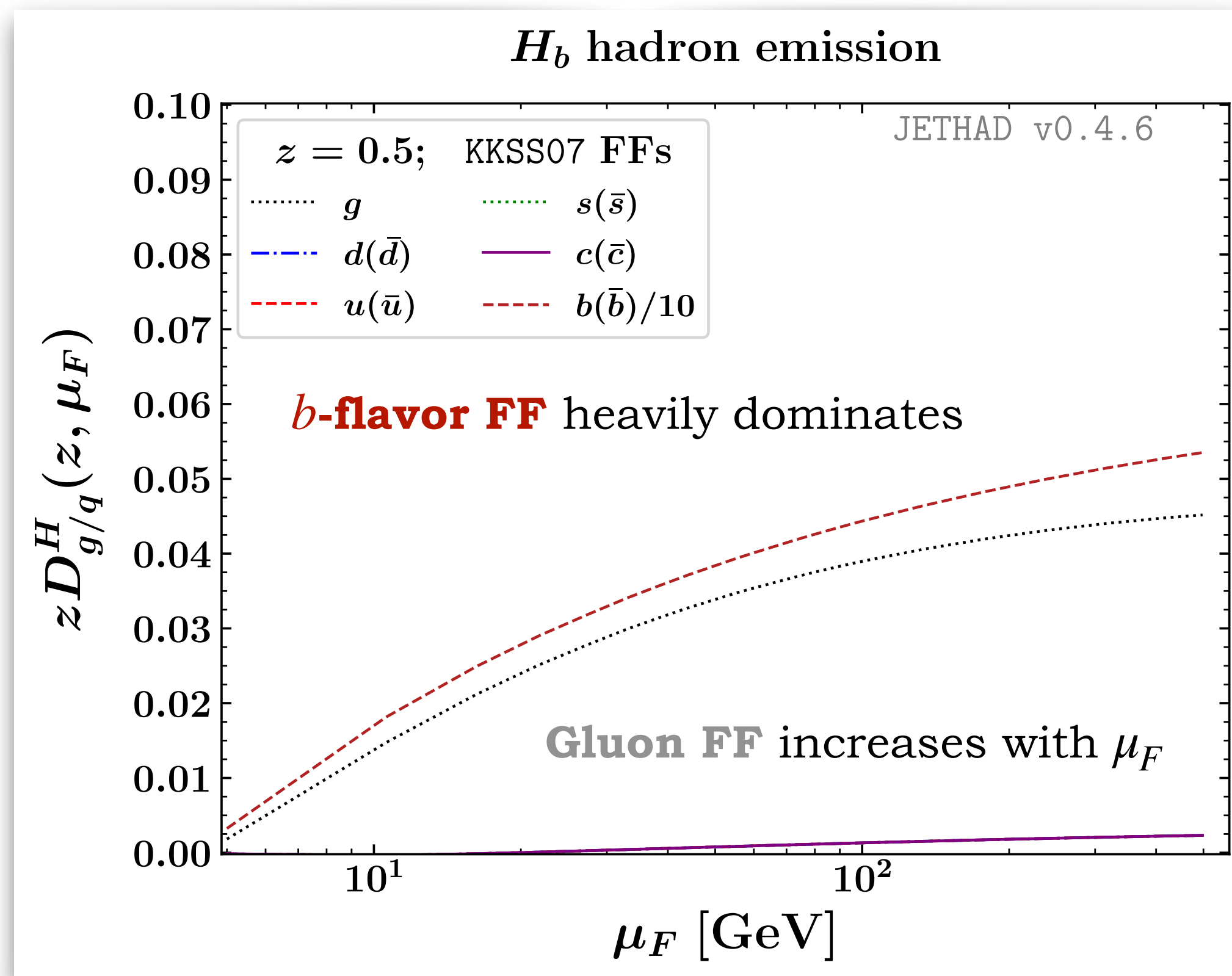

Rapidity distribution **very stable** under scale variations

(H_b hadrons, in this slide) [\[F. G. C. et al., Phys. Rev. D 104 \(2021\) 11, 114007\]](#)

(Λ_c baryons) [\[F. G. C. et al., Eur. Phys. J. C 81 \(2021\) 8, 780\]](#)

Stabilizing effects of heavy-flavor fragmentation

 Stabilization mechanism encoded in the heavy-flavor **gluon FF**

 Forward-hadron LO impact factor \Rightarrow **gluon FF** enhanced by **gluon PDF** in collinear convolution

$$c_{\Lambda}(n, \nu, |\vec{p}|, x) = 2\sqrt{\frac{C_F}{C_A}} (|\vec{p}|^2)^{i\nu-1/2} \int_x^1 \frac{dz}{z} \left(\frac{z}{x}\right)^{2i\nu-1} \left[\frac{C_A}{C_F} f_g(z) D_g^{\Lambda} \left(\frac{x}{z}\right) + \sum_{a=q, \bar{q}} f_a(z) D_a^{\Lambda} \left(\frac{x}{z}\right) \right]$$

Stabilizing effects of heavy-flavor fragmentation

Stabilization mechanism encoded in the heavy-flavor **gluon FF**

Forward-hadron LO impact factor \Rightarrow **gluon FF** enhanced by **gluon PDF** in collinear convolution

$$c_\Lambda(n, \nu, |\vec{p}|, x) = 2\sqrt{\frac{C_F}{C_A}} (|\vec{p}|^2)^{i\nu-1/2} \int_x^1 \frac{dz}{z} \left(\frac{z}{x}\right)^{2i\nu-1} \left[\frac{C_A}{C_F} f_g(z) D_g^\Lambda\left(\frac{x}{z}\right) + \sum_{a=q,\bar{q}} f_a(z) D_a^\Lambda\left(\frac{x}{z}\right) \right]$$

Forward-hadron NLO impact factor \Rightarrow a **non-diagonal heavy-flavor** channel open...

$$c_1^{(1)}(n, \nu, |\vec{k}_1|, \alpha_1) = 2\sqrt{\frac{C_F}{C_A}} (\vec{k}_1^2)^{i\nu-\frac{1}{2}} \frac{1}{2\pi} \int_{\alpha_1}^1 \frac{dx}{x} \int_{\frac{\alpha_1}{x}}^1 \frac{d\zeta}{\zeta} \left(\frac{x\zeta}{\alpha_1}\right)^{2i\nu-1}$$

$$\times \left[\frac{C_A}{C_F} f_g(x) D_g^h\left(\frac{\alpha_1}{x\zeta}\right) C_{gg}(x, \zeta) + \sum_{a=q,\bar{q}} f_a(x) D_a^h\left(\frac{\alpha_1}{x\zeta}\right) C_{qq}(x, \zeta) \right]$$

$$+ \left[D_g^h\left(\frac{\alpha_1}{x\zeta}\right) \sum_{a=q,\bar{q}} f_a(x) C_{qg}(x, \zeta) + \frac{C_A}{C_F} f_g(x) \sum_{a=q,\bar{q}} D_a^h\left(\frac{\alpha_1}{x\zeta}\right) C_{gq}(x, \zeta) \right]$$

...but $|C_{gg}| \sim 50 \div 10^4 |C_{gq}|$

Stabilizing effects of heavy-flavor fragmentation

Stabilization mechanism encoded in the heavy-flavor **gluon FF**

Forward-hadron LO impact factor \Rightarrow **gluon FF** enhanced by **gluon PDF** in collinear convolution

$$c_\Lambda(n, \nu, |\vec{p}|, x) = 2\sqrt{\frac{C_F}{C_A}} (|\vec{p}|^2)^{i\nu-1/2} \int_x^1 \frac{dz}{z} \left(\frac{z}{x}\right)^{2i\nu-1} \left[\frac{C_A}{C_F} f_g(z) D_g^\Lambda\left(\frac{x}{z}\right) + \sum_{a=q,\bar{q}} f_a(z) D_a^\Lambda\left(\frac{x}{z}\right) \right]$$

Forward-hadron NLO impact factor \Rightarrow a **non-diagonal heavy-flavor** channel open...

$$c_1^{(1)}(n, \nu, |\vec{k}_1|, \alpha_1) = 2\sqrt{\frac{C_F}{C_A}} (\vec{k}_1^2)^{i\nu-\frac{1}{2}} \frac{1}{2\pi} \int_{\alpha_1}^1 \frac{dx}{x} \int_{\frac{\alpha_1}{x}}^1 \frac{d\zeta}{\zeta} \left(\frac{x\zeta}{\alpha_1}\right)^{2i\nu-1} \\ \times \left[\frac{C_A}{C_F} f_g(x) D_g^h\left(\frac{\alpha_1}{x\zeta}\right) C_{gg}(x, \zeta) + \sum_{a=q,\bar{q}} f_a(x) D_a^h\left(\frac{\alpha_1}{x\zeta}\right) C_{qq}(x, \zeta) \right. \\ \left. + D_g^h\left(\frac{\alpha_1}{x\zeta}\right) \sum_{a=q,\bar{q}} f_a(x) C_{qg}(x, \zeta) + \frac{C_A}{C_F} f_g(x) \sum_{a=q,\bar{q}} D_a^h\left(\frac{\alpha_1}{x\zeta}\right) C_{gq}(x, \zeta) \right] \quad \dots \text{but } |C_{gg}| \sim 50 \div 10^4 |C_{gq}|$$

Gluon FF rises with energy \Rightarrow this **compensates** PDF and BFKL kernel decreasing behavior

BASICS OF BFKL

The high-energy resummation

- **BFKL resummation:** [V.S. Fadin, E.A. Kuraev, L.N. Lipatov (1975, 1976, 1977); Y.Y. Balitskii, L.N. Lipatov (1978)]

based on \longrightarrow **gluon Reggeization**

leading logarithmic approximation (LL):

$$\alpha_s^n (\ln s)^n$$

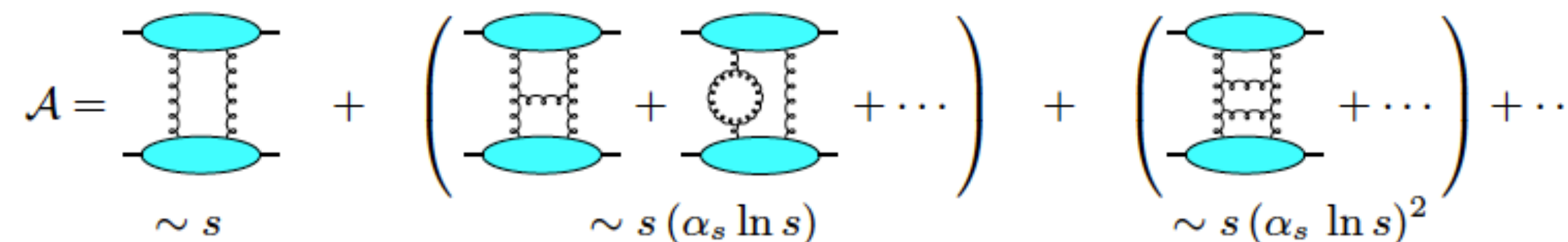

next-to-leading logarithmic approximation (NLL):

$$\alpha_s^{n+1} (\ln s)^n$$

Total cross section for $A + B \rightarrow X$: $\sigma_{AB}(s) = \frac{\text{Im}_s \{ \mathcal{A}_{AB}^{AB} \}}{s} \Leftarrow$ **optical theorem**

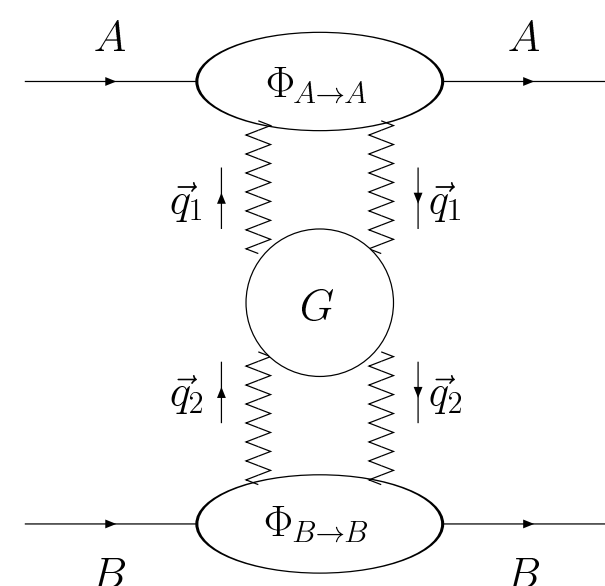

► $\text{Im}_s \{ \mathcal{A}_{AB}^{AB} \}$ factorization:

convolution of the **Green's function** of two interacting Reggeized gluons with the **impact factors** of the colliding particles

Green's function is **process-independent**, describes energy dependence and obeys BFKL equation; impact factors are known in the **NLL just for few processes**

The high-energy resummation

$$\text{Im}_s (\mathcal{A}) = \frac{s}{(2\pi)^{D-2}} \int \frac{d^{D-2}q_1}{\vec{q}_1^2} \Phi_A(\vec{q}_1, \mathbf{s}_0) \int \frac{d^{D-2}q_2}{\vec{q}_2^2} \Phi_B(-\vec{q}_2, \mathbf{s}_0) \int_{\delta-i\infty}^{\delta+i\infty} \frac{d\omega}{2\pi i} \left(\frac{s}{s_0}\right)^\omega G_\omega(\vec{q}_1, \vec{q}_2)$$

- **Green's function** is **process-independent** and takes care of the **energy dependence**

→ determined through the **BFKL equation**

[Ya.Ya. Balitskii, V.S. Fadin, E.A. Kuraev, L.N. Lipatov (1975)]

- **Impact factors** are **process-dependent** and depend on the hard scale, but not on the energy

→ known in the NLA just for few processes

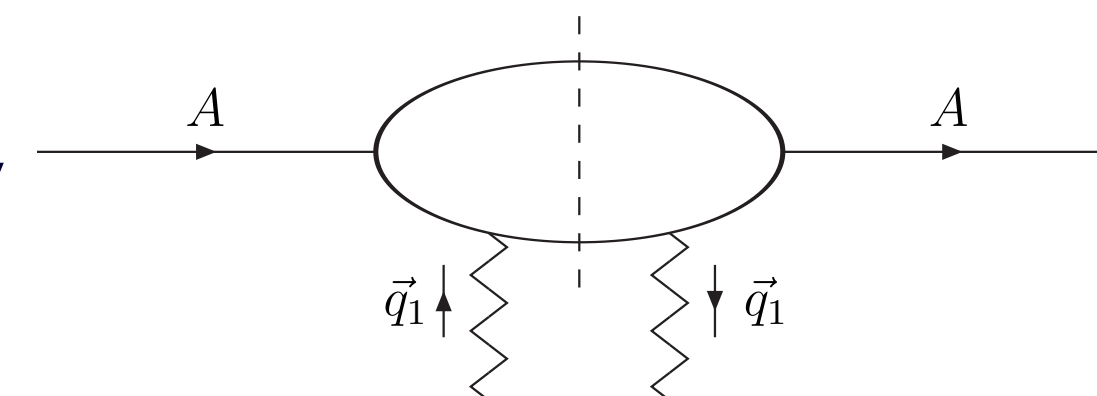

- Successful tests of NLA BFKL in the **Mueller–Navelet** channel with the advent of the LHC; nevertheless, *new BFKL-sensitive observables* as well as *more exclusive final-state reactions* are needed (**di-hadron**, **hadron-jet**, **heavy-quark pair**, **multi-jet**, production processes,...)

(**MN jets**) [B. Ducloué, L. Szymanowski, S. Wallon (2014); F.G.C., D.Yu. Ivanov, B. Murdaca, A. Papa (2015, 2016)]

(**di-hadron**) [F.G.C., D.Yu. Ivanov, B. Murdaca, A. Papa (2016, 2017)]

(**four-jet**) [F. Caporale, F.G.C., G. Chachamis, A. Sabio Vera (2016)]

(**multi-jet**) [F. Caporale, F.G.C., G. Chachamis, D. Gordo Gómez, A. Sabio Vera (2016, 2017, 2017)]

(**heavy-quark pair**) [F.G.C., D.Yu. Ivanov, B. Murdaca, A. Papa (2018); A.D. Bolognino, F.G.C., D.Yu. Ivanov, M. Fucilla, A. Papa (2018)]

(**hadron-jet**) [M.M.A. Mohammed, MD thesis (2018); A.D. Bolognino, F.G.C., D.Yu. Ivanov, M.M.A. Mohammed, A. Papa (2018)]

The high-energy resummation

$$\text{Im}_s (\mathcal{A}) = \frac{s}{(2\pi)^{D-2}} \int \frac{d^{D-2}q_1}{\vec{q}_1^2} \Phi_A(\vec{q}_1, \mathbf{s}_0) \int \frac{d^{D-2}q_2}{\vec{q}_2^2} \Phi_B(-\vec{q}_2, \mathbf{s}_0) \int_{\delta-i\infty}^{\delta+i\infty} \frac{d\omega}{2\pi i} \left(\frac{s}{\mathbf{s}_0}\right)^\omega G_\omega(\vec{q}_1, \vec{q}_2)$$

- **Green's function** is **process-independent** and takes care of the **energy dependence**

→ determined through the **BFKL equation**

[Ya.Ya. Balitskii, V.S. Fadin, E.A. Kuraev, L.N. Lipatov (1975)]

- **Impact factors** are **process-dependent** and depend on the hard scale, but not on the energy

→ known in the NLA just for few processes

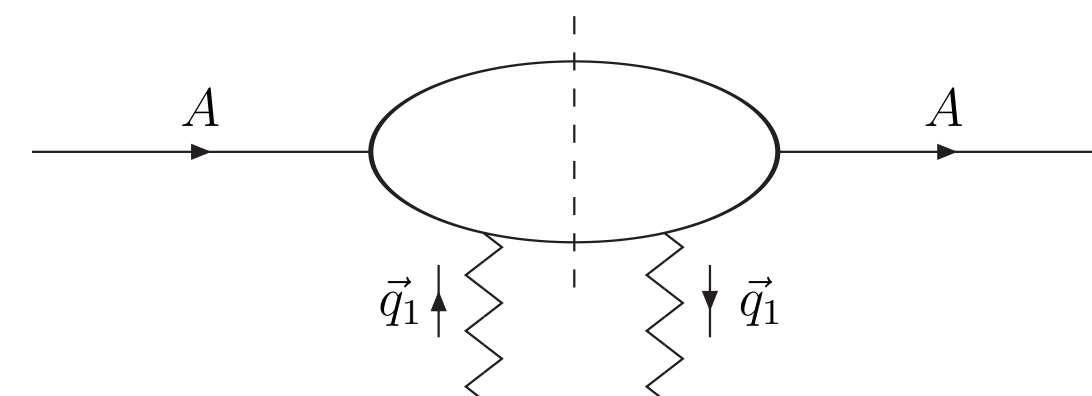

- Successful tests of NLA BFKL in the **Mueller–Navelet** channel with the advent of the LHC; nevertheless, *new BFKL-sensitive observables* as well as *more exclusive final-state reactions* are needed (**di-hadron**, **hadron-jet**, **heavy-quark pair**, **multi-jet**, production processes,...)

(**MN jets**) [B. Ducloué, L. Szymanowski, S. Wallon (2014); F.G.C., D.Yu. Ivanov, B. Murdaca, A. Papa (2015, 2016)]

(**di-hadron**) [F.G.C., D.Yu. Ivanov, B. Murdaca, A. Papa (2016, 2017)]

(**four-jet**) [F. Caporale, F.G.C., G. Chachamis, A. Sabio Vera (2016)]

(**multi-jet**) F. Caporale, F.G.C., G. Chachamis, D. Gordo Gómez, A. Sabio Vera (2016, 2017, 2017)]

(**heavy-quark pair**) [F.G.C., D.Yu. Ivanov, B. Murdaca, A. Papa (2018); A.D. Bolognino, F.G.C., D.Yu. Ivanov, M. Fucilla, A. Papa (2018)]

(**hadron-jet**) [M.M.A. Mohammed, MD thesis (2018); A.D. Bolognino, F.G.C., D.Yu. Ivanov, M.M.A. Mohammed, A. Papa (2018)]

(κ_T space) [M. Hentschinski et al. (2021)]

(κ_T & Mellin) [F.G.C. et al. (2022)]

I NEW!
NLO HIGGS

Backup

The high-energy resummation

Glue Reggeization in perturbative QCD

◇ Glue quantum numbers in the t -channel: 8^- representation

◇ Regge limit: $s \simeq -u \rightarrow \infty$, t not growing with s

→ amplitudes governed by **glue Reggeization** $\rightarrow D_{\mu\nu} = -i \frac{g_{\mu\nu}}{q^2} \left(\frac{s}{s_0}\right)^{\alpha_g(q^2)-1}$

$\xrightarrow{\text{feature}}$ all-order resummation: **LLA** [$\alpha_s^n (\ln s)^n$] + **NLA** [$\alpha_s^{n+1} (\ln s)^n$]

$\xrightarrow{\text{consequence}}$ factorization of elastic and real part of inelastic amplitudes

$\xrightarrow{\text{example}}$ Elastic scattering process: $A + B \rightarrow A' + B'$

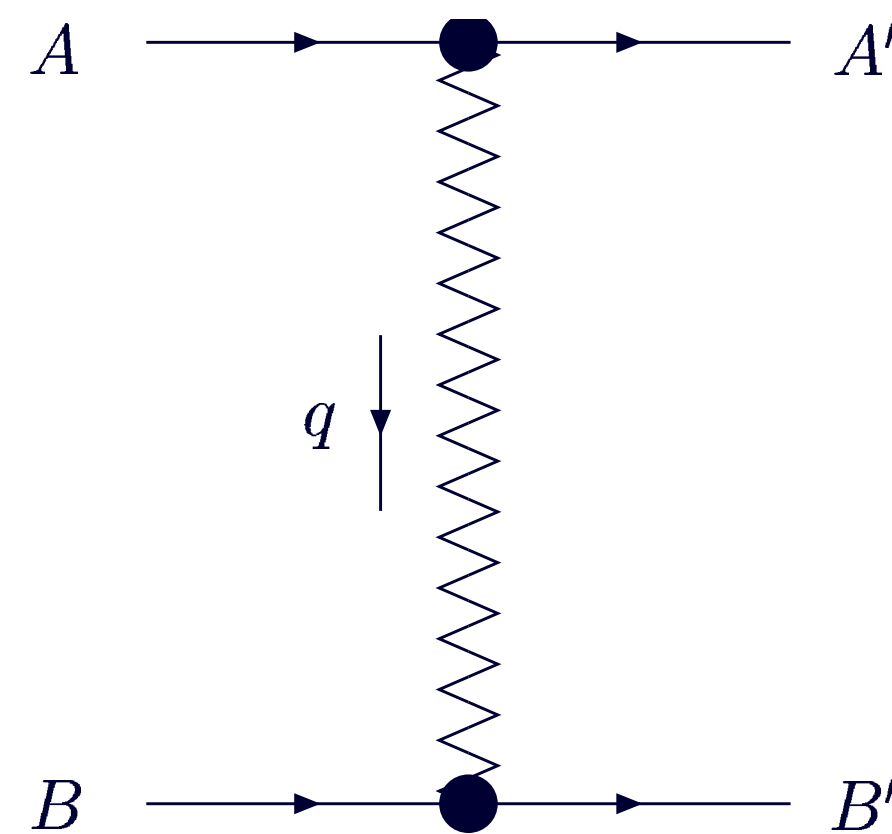

$$(\mathcal{A}_8^-)_{AB}^{A'B'} = \Gamma_{A'A}^c \left[\left(\frac{-s}{-t}\right)^{j(t)} - \left(\frac{s}{-t}\right)^{j(t)} \right] \Gamma_{B'B}^c$$

$$j(t) = 1 + \omega(t), \quad j(0) = 1$$

$\omega(t) \rightarrow$ Reggeized gluon trajectory

$$\Gamma_{A'A}^c = g \langle A' | T^c | A \rangle \Gamma_{A'A} \rightarrow \text{PPR vertex}$$

$T^c \rightarrow$ fundamental (q) or adjoint (g)

- QCD is the unique SM theory where all elementary particles reggeize
- Possible extensions: N=4 SYM, AdS/CFT,...

The high-energy resummation

$$\text{Im}_s \{ \mathcal{A} \} = \frac{s}{(2\pi)^{D-2}} \int \frac{d^{D-2} q_1}{\vec{q}_1^2} \Phi_A(\vec{q}_1, \mathbf{s}_0) \int \frac{d^{D-2} q_2}{\vec{q}_2^2} \Phi_B(-\vec{q}_2, \mathbf{s}_0) \int_{\delta-i\infty}^{\delta+i\infty} \frac{d\omega}{2\pi i} \left(\frac{s}{s_0} \right)^\omega G_\omega(\vec{q}_1, \vec{q}_2)$$

- **Green's function** is **process-independent** and takes care of the **energy dependence**

→ determined through the **BFKL equation**

[Ya.Ya. Balitskii, V.S. Fadin, E.A. Kuraev, L.N. Lipatov (1975)]

$$\omega G_\omega(\vec{q}_1, \vec{q}_2) = \delta^{D-2}(\vec{q}_1 - \vec{q}_2) + \int d^{D-2} q K(\vec{q}_1, \vec{q}) G_\omega(\vec{q}, \vec{q}_1).$$

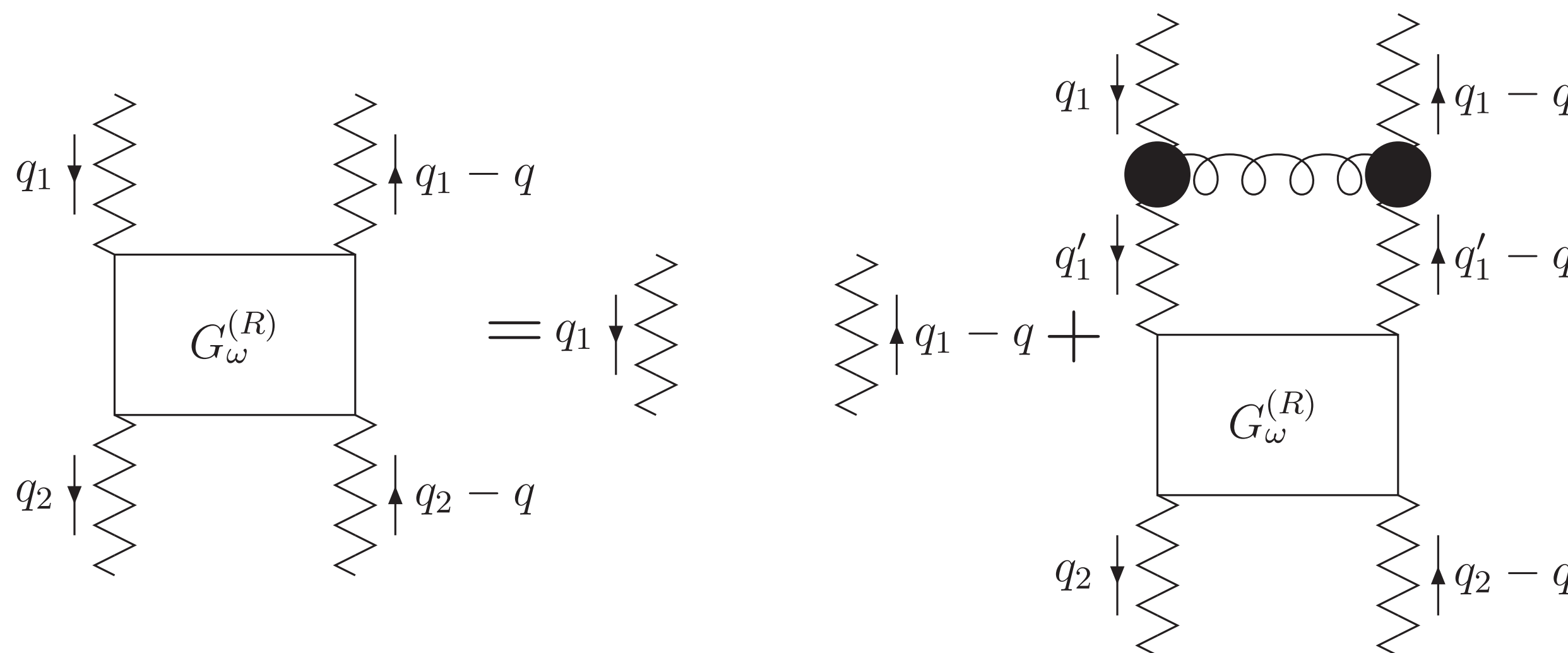

The high-energy resummation

- **Impact factors** are **process-dependent** and depend on the hard scale, but not on the energy
→ known in the NLA just for few processes

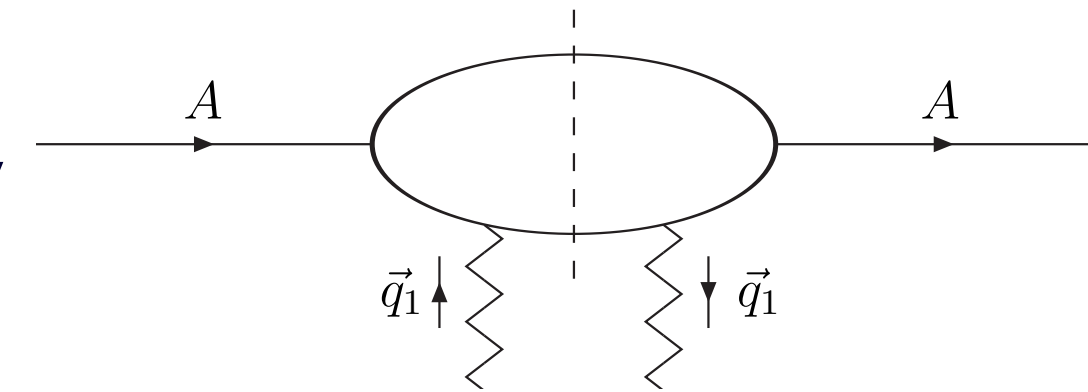

[V.S. Fadin, R. Fiore, M.I. Kotsky, A. Papa (2000)]
[M. Ciafaloni, G. Rodrigo (2000)]

- ◇ $\gamma^* \longrightarrow V$, with $V = \rho^0, \omega, \phi$, forward case

[D.Yu. Ivanov, M.I. Kotsky, A. Papa (2004)]

- ◇ forward jet production

[J. Bartels, D. Colferai, G.P. Vacca (2003)]

(exact IF) [F. Caporale, D.Yu. Ivanov, B. Murdaca, A. Papa, A. Perri (2012)]

(small-cone IF) [D.Yu. Ivanov, A. Papa (2012)]

(several jet algorithms discussed) [D. Colferai, A. Niccoli (2015)]

- ◇ forward identified hadron production

[D.Yu. Ivanov, A. Papa (2012)]

- ◇ $\gamma^* \longrightarrow \gamma^*$

[J. Bartels *et al.* (2001), I. Balitsky, G.A. Chirilli (2011, 2013)]

The high-energy resummation

BFKL in the LLA (I)

Inelastic scattering process $A + B \rightarrow \tilde{A} + \tilde{B} + n$ in the LLA

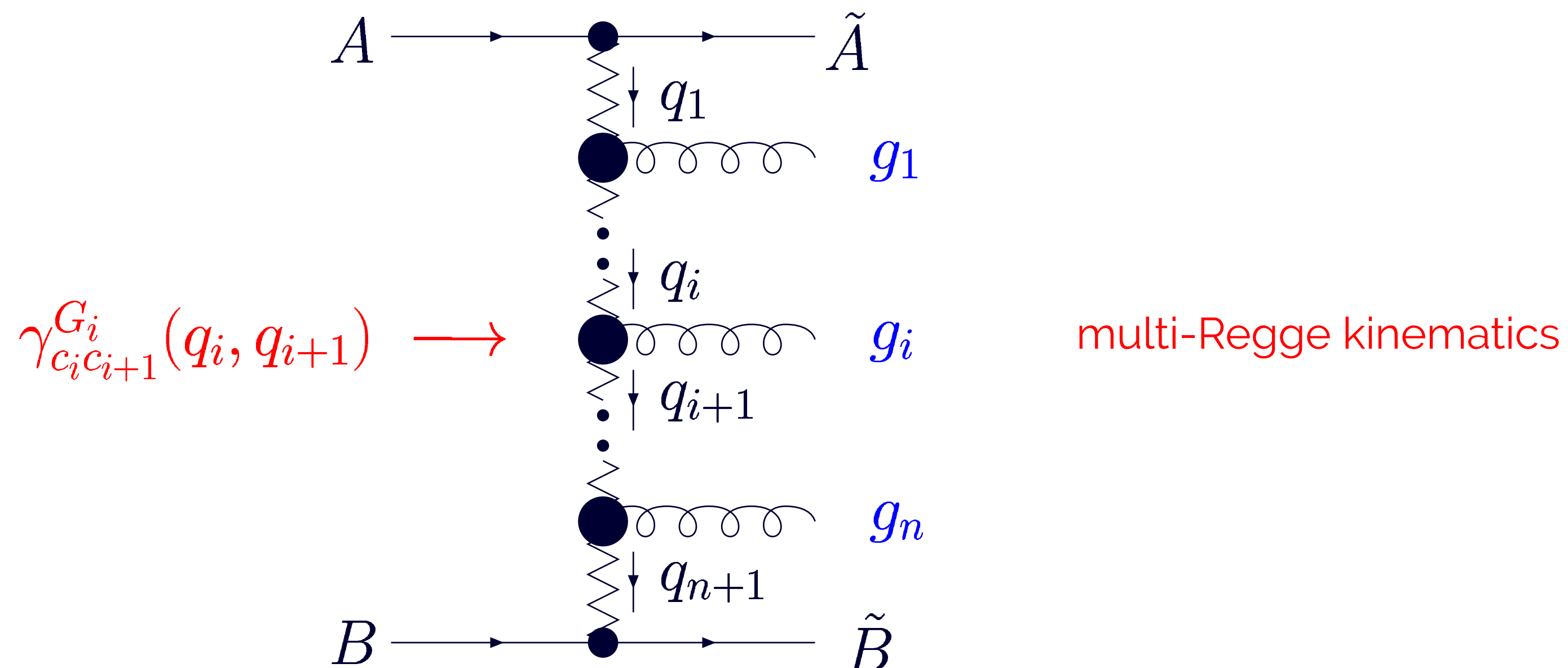

$$\text{Re} \mathcal{A}_{AB}^{\tilde{A}\tilde{B}+n} = 2s \Gamma_{\tilde{A}A}^{c_1} \left(\prod_{i=1}^n \gamma_{c_i c_{i+1}}^{P_i}(q_i, q_{i+1}) \left(\frac{s_i}{s_R} \right)^{\omega(t_i)} \frac{1}{t_i} \right) \frac{1}{t_{n+1}} \left(\frac{s_{n+1}}{s_R} \right)^{\omega(t_{n+1})} \Gamma_{\tilde{B}B}^{c_{n+1}}$$

$\gamma_{c_i c_{i+1}}^{P_i}(q_i, q_{i+1}) \rightarrow$ RRG vertex

$s_R \rightarrow$ energy scale, irrelevant in the LLA

The high-energy resummation

BFKL in the LLA (II)

Elastic amplitude $A + B \longrightarrow A' + B'$ in the LLA via s -channel unitarity

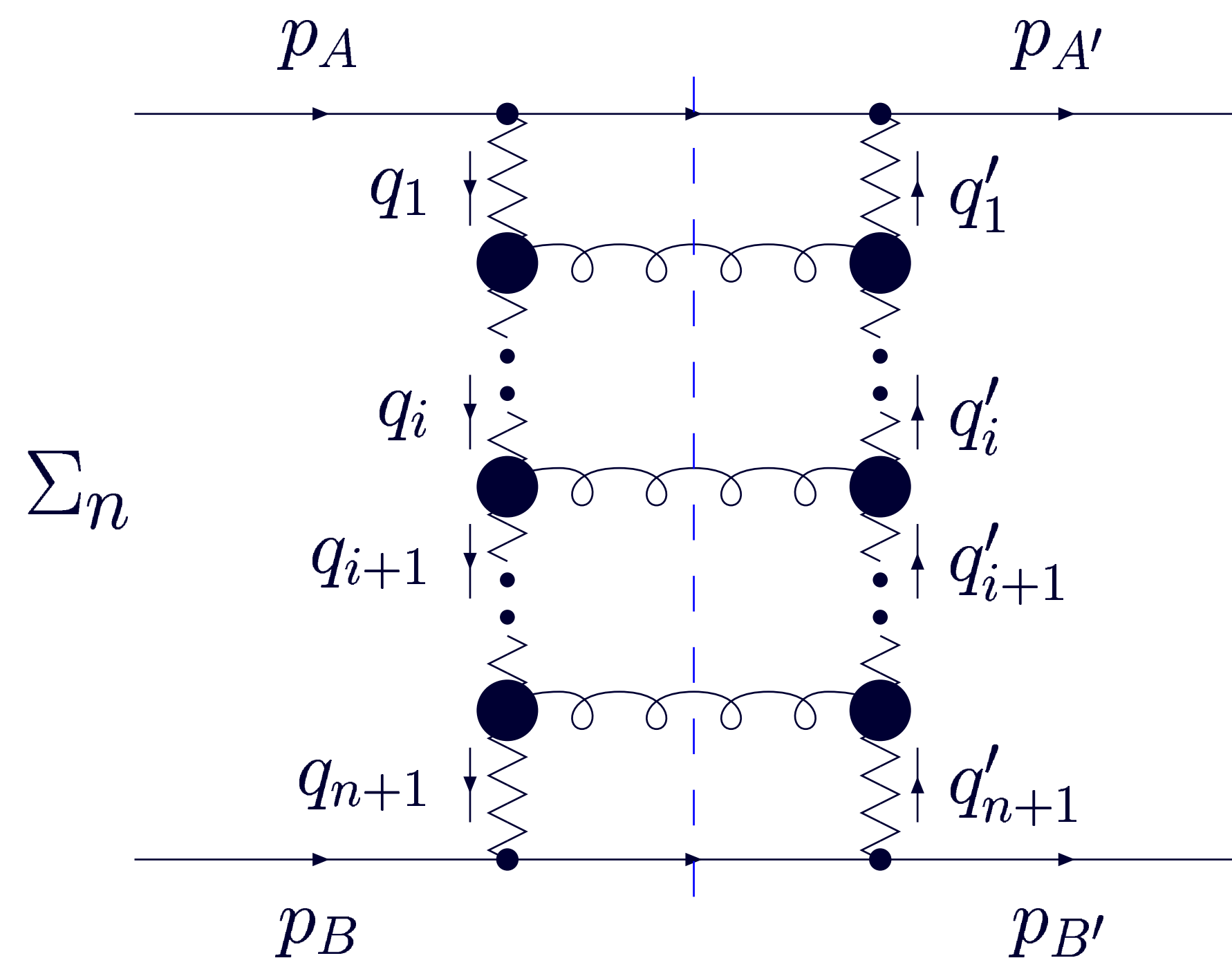

$$\mathcal{A}_{AB}^{A'B'} = \sum_{\mathcal{R}} (\mathcal{A}_{\mathcal{R}})^{A'B'}_{AB}, \quad \mathcal{R} = 1 \text{ (singlet), } 8^- \text{ (octet), } \dots$$

The 8^- color representation is important for the **bootstrap**, i.e. the consistency between the above amplitude and that with one Reggeized gluon exchange

Hybrid factorization at work

Forward-jet impact factor

- take the impact factors for **colliding partons**

[V.S. Fadin, R. Fiore, M.I. Kotsky, A. Papa (2000)]

[M. Ciafaloni and G. Rodrigo (2000)]

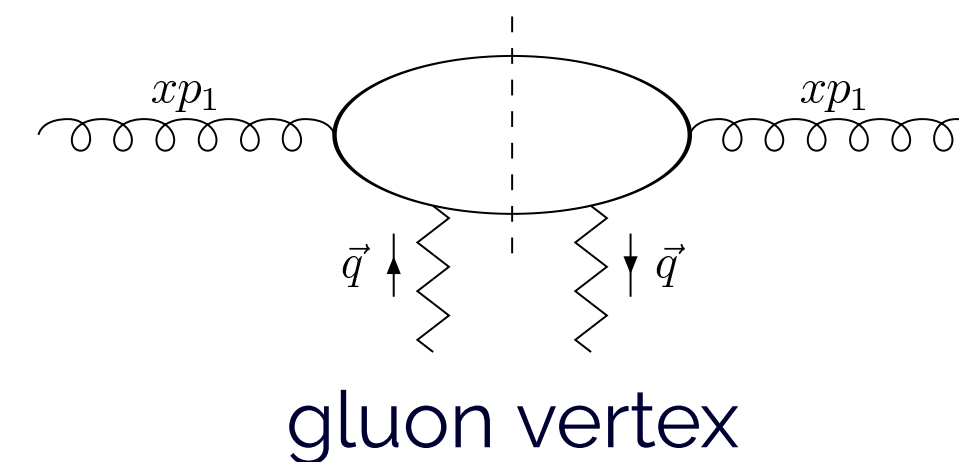
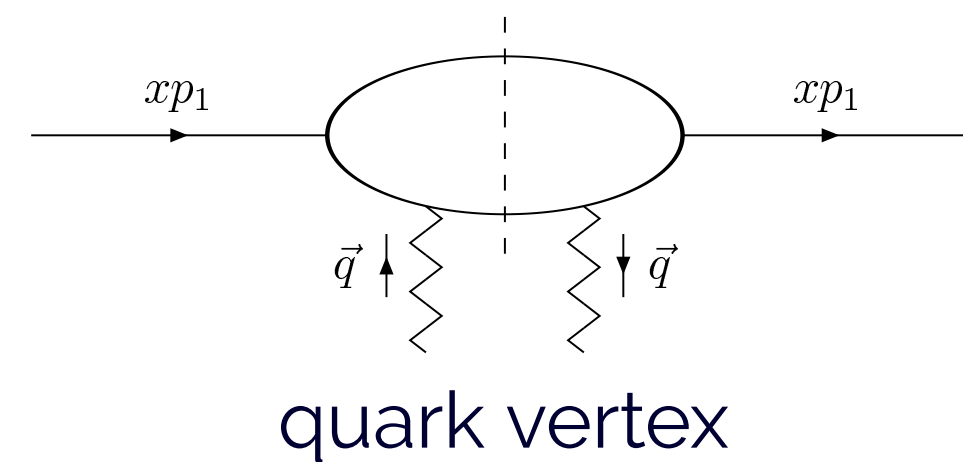

- “open” one of the integrations over the phase space of the intermediate state to allow one parton to generate the jet

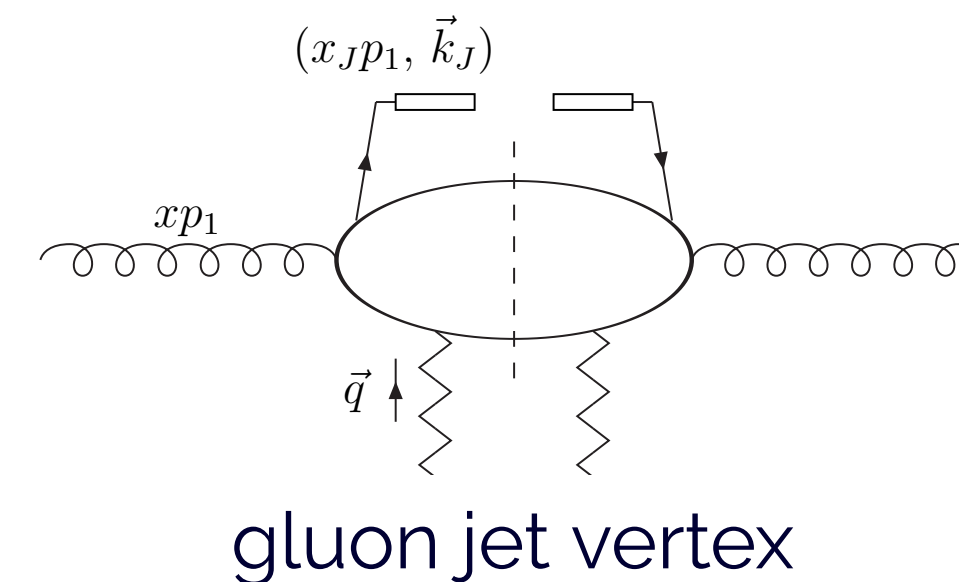
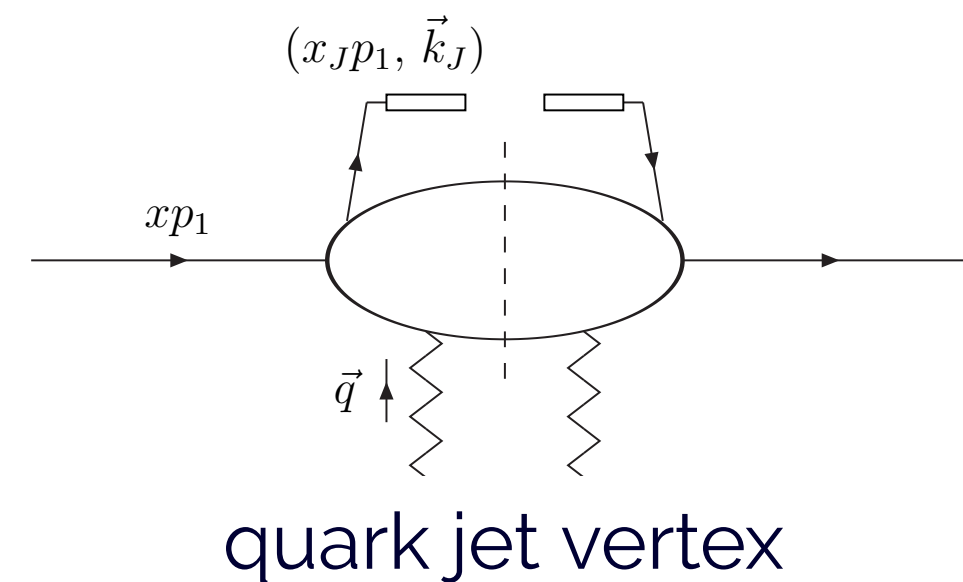

- use QCD collinear factoriz.: $\sum_{s=q,\bar{q}} f_s \otimes [\text{quark vertex}] + f_g \otimes [\text{gluon vertex}]$

Forward-Higgs LO impact factor

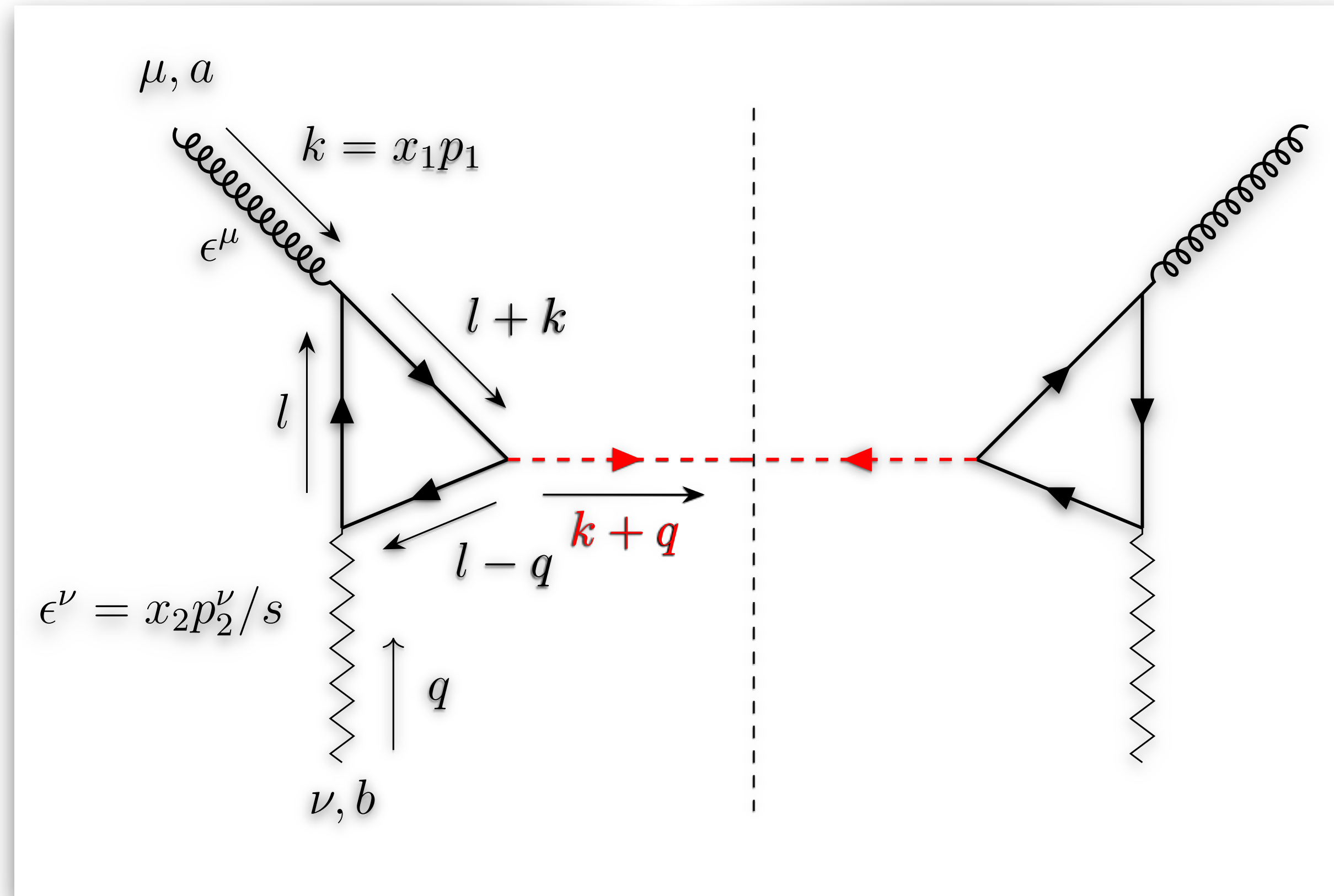

$$\frac{d\Phi_J^{(0)}(\nu, n)}{dx_J d^2\vec{p}_J} = 2\alpha_s \sqrt{\frac{C_F}{C_A}} (\vec{p}_J^2)^{i\nu-3/2} \left(\frac{C_A}{C_F} f_g(x_J) + \sum_{a=q\bar{q}} f_a(x_J) \right) e^{in\phi_J}$$

Forward-Higgs NLO-RG impact factor

$$\begin{aligned} \tilde{c}_H^{(1)}(n, \nu, |\vec{p}_H|, x_H) = c_H(n, \nu, |\vec{p}_H|, x_H) & \left\{ \frac{\beta_0}{4N_c} \left(2 \ln \frac{\mu_{R_1}}{|\vec{p}_H|} + \frac{5}{3} \right) + \frac{\chi(n, \nu)}{2} \ln \left(\frac{s_0}{M_{H,\perp}^2} \right) \right. \\ & + \frac{\beta_0}{4N_c} \left(2 \ln \frac{\mu_{R_1}}{M_{H,\perp}} \right) \\ & \left. - \frac{1}{2N_c f_g(x_H, \mu_{F_1})} \ln \frac{\mu_{F_1}^2}{M_{H,\perp}^2} \int_{x_H}^1 \frac{dz}{z} \left[P_{gg}(z) f_g \left(\frac{x_H}{z}, \mu_{F_1} \right) + \sum_{a=q, \bar{q}} P_{ga}(z) f_a \left(\frac{x_H}{z}, \mu_{F_1} \right) \right] \right\} \end{aligned}$$

Forward-jet NLO-RG impact factor

$$\begin{aligned}
 \tilde{c}_J^{(1)}(n, \nu, |\vec{p}_J|, x_J) = & c_J(n, \nu, |\vec{p}_J|, x_J) \left\{ \frac{\beta_0}{4N_c} \left(2 \ln \frac{\mu_{R_2}}{|\vec{p}_J|} + \frac{5}{3} \right) + \frac{\chi(n, \nu)}{2} \ln \left(\frac{s_0}{|\vec{p}_J|^2} \right) \right. \\
 & - \frac{1}{2N_c \left(\frac{C_A}{C_F} f_g(x_J, \mu_{F_2}) + \sum_{a=q, \bar{q}} f_a(x_J, \mu_{F_2}) \right)} \ln \frac{\mu_{F_2}^2}{|\vec{p}_J|^2} \\
 & \times \left(\frac{C_A}{C_F} \int_{x_J}^1 \frac{dz}{z} \left[P_{gg}(z) f_g \left(\frac{x_J}{z}, \mu_{F_2} \right) + \sum_{a=q, \bar{q}} P_{ga}(z) f_a \left(\frac{x_J}{z}, \mu_{F_2} \right) \right] \right. \\
 & \left. \left. + \sum_{a=q, \bar{q}} \int_{x_J}^1 \frac{dz}{z} \left[P_{ag}(z) f_g \left(\frac{x_J}{z}, \mu_{F_2} \right) + P_{aa}(z) f_a \left(\frac{x_J}{z}, \mu_{F_2} \right) \right] \right) \right\} .
 \end{aligned}$$

Inclusive Higgs + jet: NLL/NLO* azimuthal coefficients

$$\begin{aligned}
 C_n &= \frac{e^{\Delta Y}}{s} \frac{M_{H,\perp}}{|\vec{p}_H|} \\
 &\times \int_{-\infty}^{+\infty} d\nu \left(\frac{x_J x_H s}{s_0} \right)^{\bar{\alpha}_s(\mu_{R_c})} \left\{ \chi(n, \nu) + \bar{\alpha}_s(\mu_{R_c}) \left[\bar{\chi}(n, \nu) + \frac{\beta_0}{8N_c} \chi(n, \nu) \left[-\chi(n, \nu) + \frac{10}{3} + 4 \ln \left(\frac{\mu_{R_c}}{\sqrt{|\vec{p}_H \vec{p}_J|}} \right) \right] \right] \right\} \\
 &\quad \times \left\{ \alpha_s^2(\mu_{R_1}) c_H(n, \nu, |\vec{p}_H|, x_H) \right\} \left\{ \alpha_s(\mu_{R_2}) [c_J(n, \nu, |\vec{p}_J|, x_J)]^* \right\} \\
 &\quad \times \left\{ 1 + \bar{\alpha}_s(\mu_{R_1}) \frac{\tilde{c}_H^{(1)}(n, \nu, |\vec{p}_H|, x_H)}{c_H(n, \nu, |\vec{p}_H|, x_H)} + \bar{\alpha}_s(\mu_{R_2}) \left[\frac{\tilde{c}_J^{(1)}(n, \nu, |\vec{p}_J|, x_J)}{c_J(n, \nu, |\vec{p}_J|, x_J)} \right]^* \right\} .
 \end{aligned}$$