

# QUARKONIUM FRAGMENTATION IN A VFNS TOWARDS NRFF1.0

Francesco Giovanni Celiberto, UAH Madrid

Grenoble



2024, April 9th



Madrid  
**UAH**



**talento**  
cm

Programa de atracción  
de talento investigador  
Comunidad de Madrid



ANIVERSARIO  
PATRIMONIO  
MUNDIAL

QCD Hydrogen Atoms

1

# Why studying Quarkonia ?

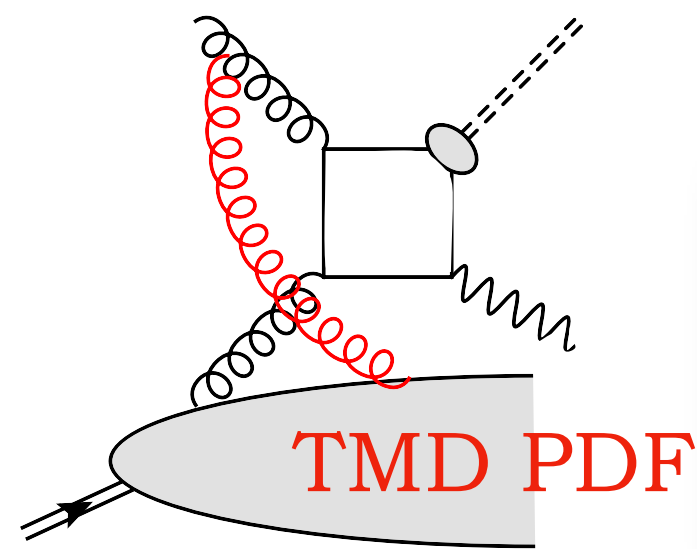
Precision & exploration

# Quarkonium physics: Assets & challenges

## Assets

 Onia  $\Rightarrow$  clean channels of f-type gluon TMDs

Initial-state color flow  $\Rightarrow$   $[-, -]$  gauge link



$$\frac{d\sigma}{dq_T} \sim$$

at low transverse momentum  
for (pseudo)scalar state

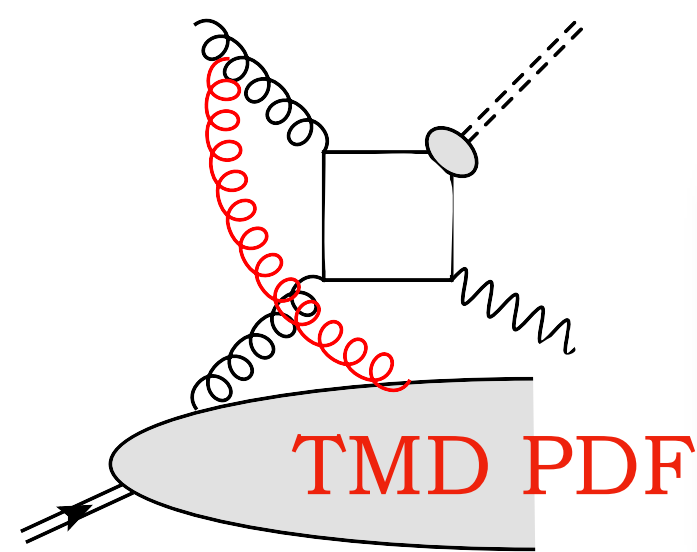
$$\sim \mathcal{C} \begin{bmatrix} f_1^{g/A} & f_1^{g/B} \end{bmatrix} \pm \mathcal{C} \begin{bmatrix} h_1^{\perp g/A} & h_1^{\perp g/B} \end{bmatrix}$$

unpolarized gluons      lin. polarized gluons

# Quarkonium physics: Assets & challenges

## Assets

 Onia  $\Rightarrow$  clean channels of f-type gluon TMDs



Initial-state color flow  $\Rightarrow$   $[-, -]$  gauge link

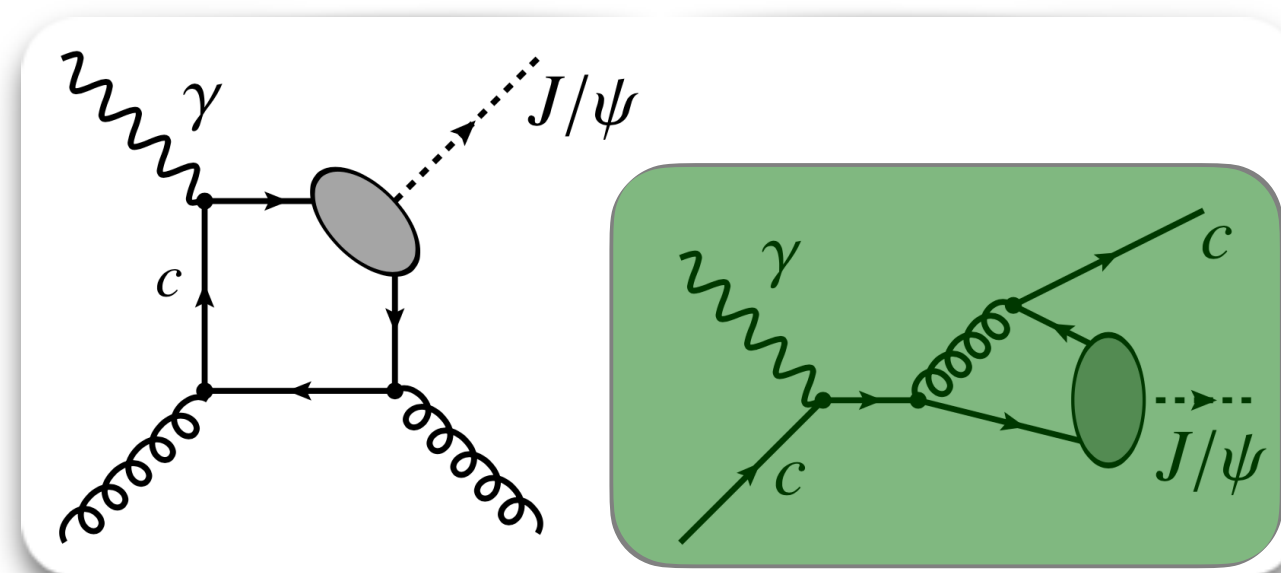
$$\frac{d\sigma}{dq_T} \sim$$

at low transverse momentum for (pseudo)scalar state

$$\sim \mathcal{C} \left[ \begin{array}{cc} f_1^{g/A} & f_1^{g/B} \\ \text{unpolarized gluons} & \end{array} \right] \pm \mathcal{C} \left[ \begin{array}{cc} h_1^{\perp g/A} & h_1^{\perp g/B} \\ \text{lin. polarized gluons} & \end{array} \right]$$

  $\gamma + g \rightarrow J/\psi + c \Rightarrow$  valence Intrinsic Charm @EIC

EIC studies:  
large  $x$   
moderate to large  $p_T$



(polarized gluon TMDs)  [A. Bacchetta, F. G. C., M. Radici (2024)]  
( $J/\psi$  @EIC)  [C. Flore, J.-P. Lansberg, H.-S. Shao, Y. Yedelkina (2020)]  
(Intrinsic Charm + valence) studies   [NNPDF Collaboration (2022, 2023)]

## Challenges

 Precision level  $\Leftrightarrow$  production mechanism(s)

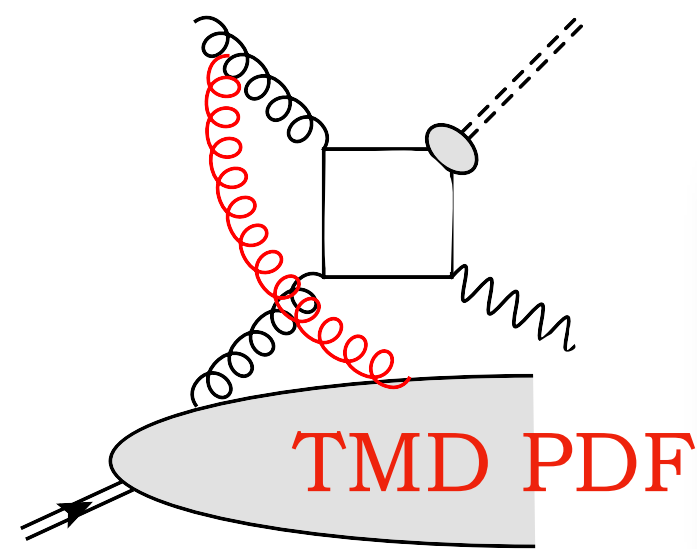
(production mechanisms, (HL-)LHC pheno)  [Quarkonia As Tools (2022)]

# Quarkonium physics: Assets & challenges

## Assets

 Onia  $\Rightarrow$  clean channels of f-type gluon TMDs

Initial-state color flow  $\Rightarrow$   $[-, -]$  gauge link



$$\frac{d\sigma}{dq_T} \sim$$

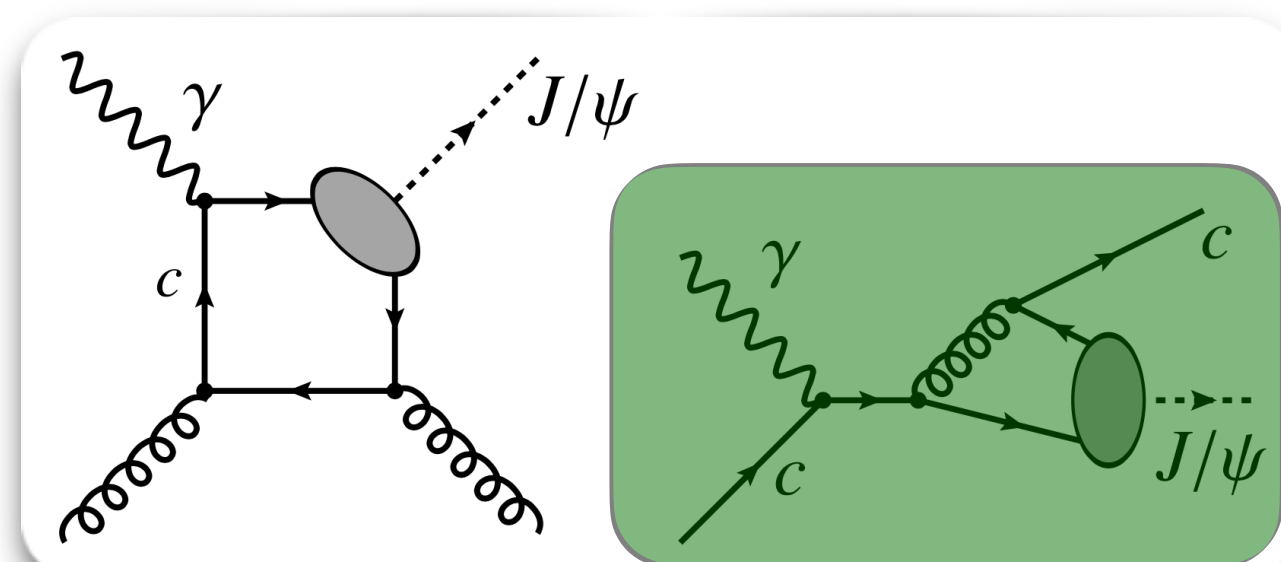
at low transverse momentum for (pseudo)scalar state

$$\sim \mathcal{C} \begin{bmatrix} f_1^{g/A} & f_1^{g/B} \end{bmatrix} \pm \mathcal{C} \begin{bmatrix} h_1^{\perp g/A} & h_1^{\perp g/B} \end{bmatrix}$$

unpolarized gluons      lin. polarized gluons

  $\gamma + g \rightarrow J/\psi + c \Rightarrow$  valence Intrinsic Charm @EIC

EIC studies:  
large  $x$   
moderate to large  $p_T$





(polarized gluon TMDs)  [A. Bacchetta, F. G. C., M. Radici (2024)]  
( $J/\psi$  @EIC)  [C. Flore, J.-P. Lansberg, H.-S. Shao, Y. Yedelkina (2020)]  
(Intrinsic Charm + valence) studies   [NNPDF Collaboration (2022, 2023)]







## Challenges

 Precision level  $\Leftrightarrow$  production mechanism(s)

(production mechanisms, (HL-)LHC pheno)  [Quarkonia As Tools (2022)]

 Color Evaporation Model    
( $Q\bar{Q}$ ) decorrelated from onium, semi-soft gluon emissions

 Color Singlet Model    
( $Q\bar{Q}$ ) to onium, no gluon emissions

 NRQCD and Color Octet       
Most complete formalism, cures P-wave divergences  
Higher Fock states, soft gluon emissions  
Fragmentation & polarization studies needed

2

Quarkonium  
formation  
from **NRQCD**

# Highlights of Non-Relativistic QCD

 **NRQCD** → effective field theory → nonrelativistic (NR)  $Q\bar{Q}$  system

 Heavy-quark spinor fields as NR DOFs in the NRQCD Lagrangian

$$\mathcal{L}_{\text{NRQCD}} = \psi^\dagger \left( iD_0 + \frac{\vec{D}^2}{2m_Q} \right) \psi + \chi^\dagger \left( iD_0 - \frac{\vec{D}^2}{2m_Q} \right) \chi + \mathcal{L}_{\text{light}} + \delta\mathcal{L}$$

# Highlights of Non-Relativistic QCD

 **NRQCD** → effective field theory → nonrelativistic (NR)  $Q\bar{Q}$  system

 Heavy-quark spinor fields as NR DOFs in the NRQCD Lagrangian

$$\mathcal{L}_{\text{NRQCD}} = \psi^\dagger \left( iD_0 + \frac{\vec{D}^2}{2m_Q} \right) \psi + \chi^\dagger \left( iD_0 - \frac{\vec{D}^2}{2m_Q} \right) \chi + \mathcal{L}_{\text{light}} + \delta\mathcal{L}$$

 [cross section] = [short-distance coeffs.]  $\otimes$  [long-distance matrix elements]

$$d\sigma(H + X) = \sum_n d\hat{\sigma}(Q\bar{Q}[n] + X) \langle \mathcal{O}^H[n] \rangle$$



# Highlights of Non-Relativistic QCD

 **NRQCD** → effective field theory → nonrelativistic (NR)  $Q\bar{Q}$  system

 Heavy-quark spinor fields as NR DOFs in the NRQCD Lagrangian

$$\mathcal{L}_{\text{NRQCD}} = \psi^\dagger \left( iD_0 + \frac{\vec{D}^2}{2m_Q} \right) \psi + \chi^\dagger \left( iD_0 - \frac{\vec{D}^2}{2m_Q} \right) \chi + \mathcal{L}_{\text{light}} + \delta\mathcal{L}$$

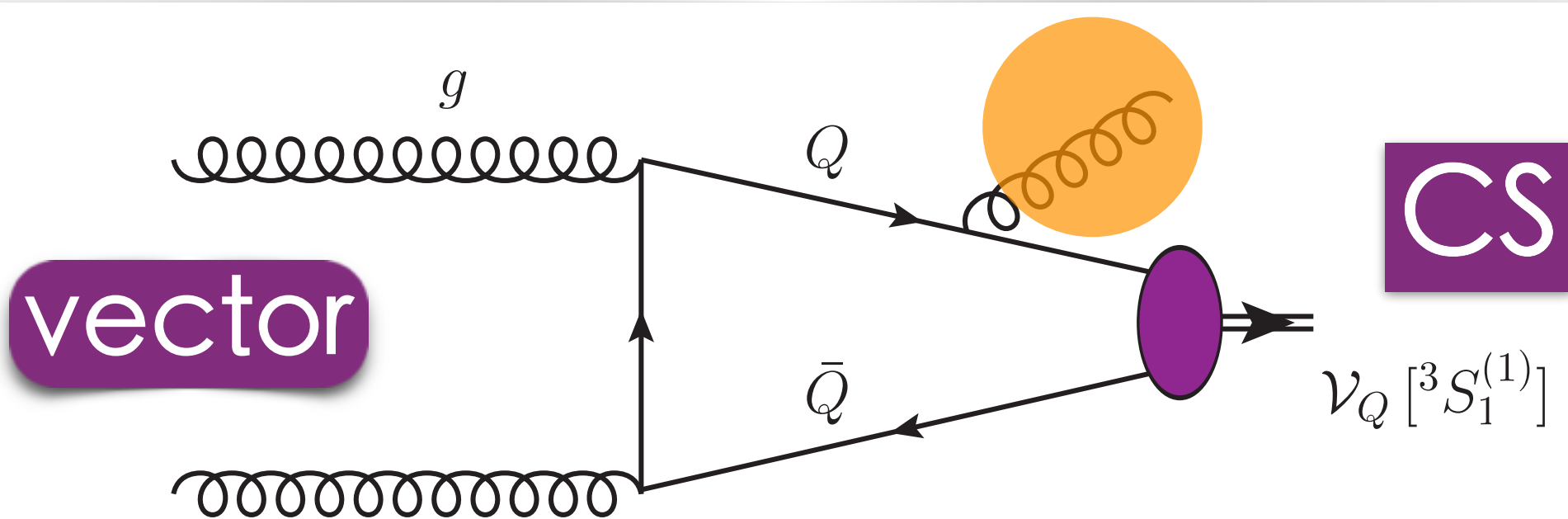
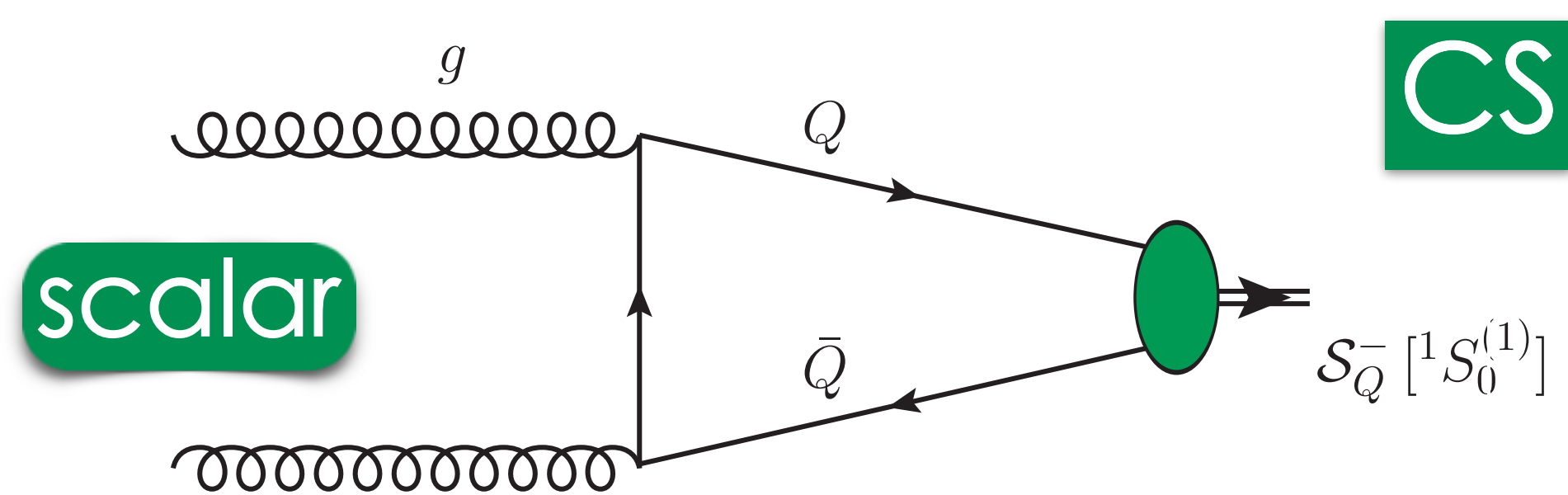
 [cross section] = [short-distance coeffs.]  $\otimes$  [long-distance matrix elements]

$$d\sigma(H + X) = \sum_n d\hat{\sigma}(Q\bar{Q}[n] + X) \langle \mathcal{O}^H[n] \rangle$$

$$|\mathcal{Q}\rangle = \mathcal{O}(1) |Q\bar{Q}[^3S_1^{(1)}]\rangle + \mathcal{O}(v) |Q\bar{Q}[^3P_J^{(8)}g]\rangle + \mathcal{O}(v^2) |Q\bar{Q}[^1S_0^{(8)}g]\rangle \\ + \mathcal{O}(v^2) |Q\bar{Q}[^3S_1^{(1,8)}gg]\rangle + \mathcal{O}(v^2) |Q\bar{Q}[^3D_J^{(1,8)}gg]\rangle + \dots$$

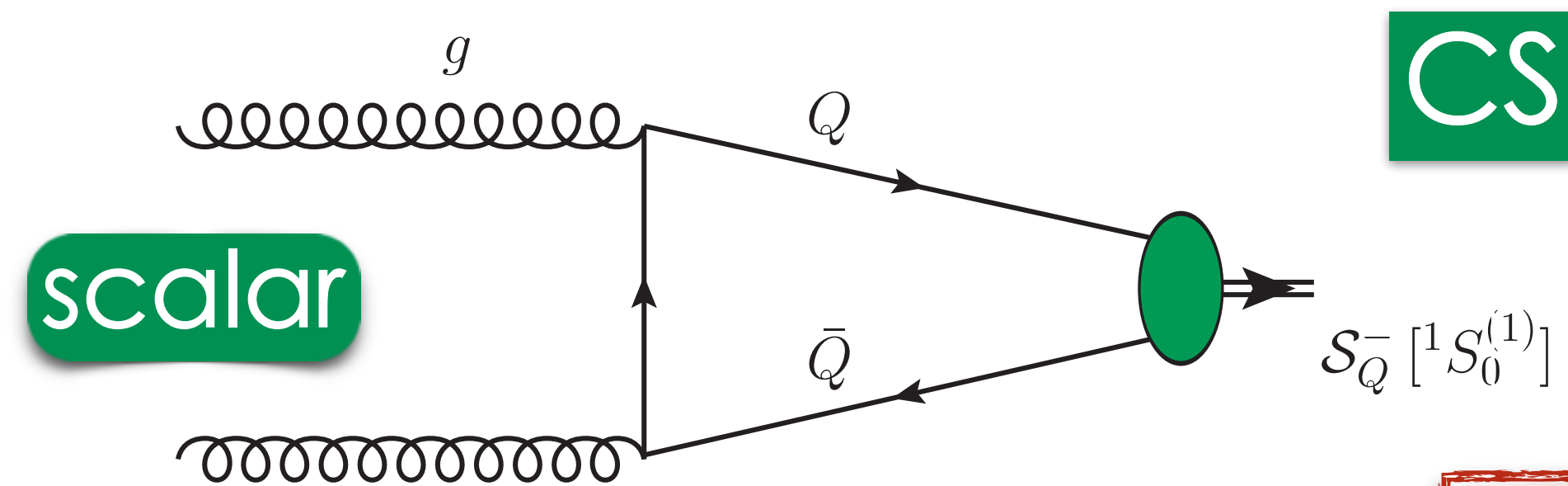
# From low energies to high energies

Low energy, low  $p_T$   
Short-distance production

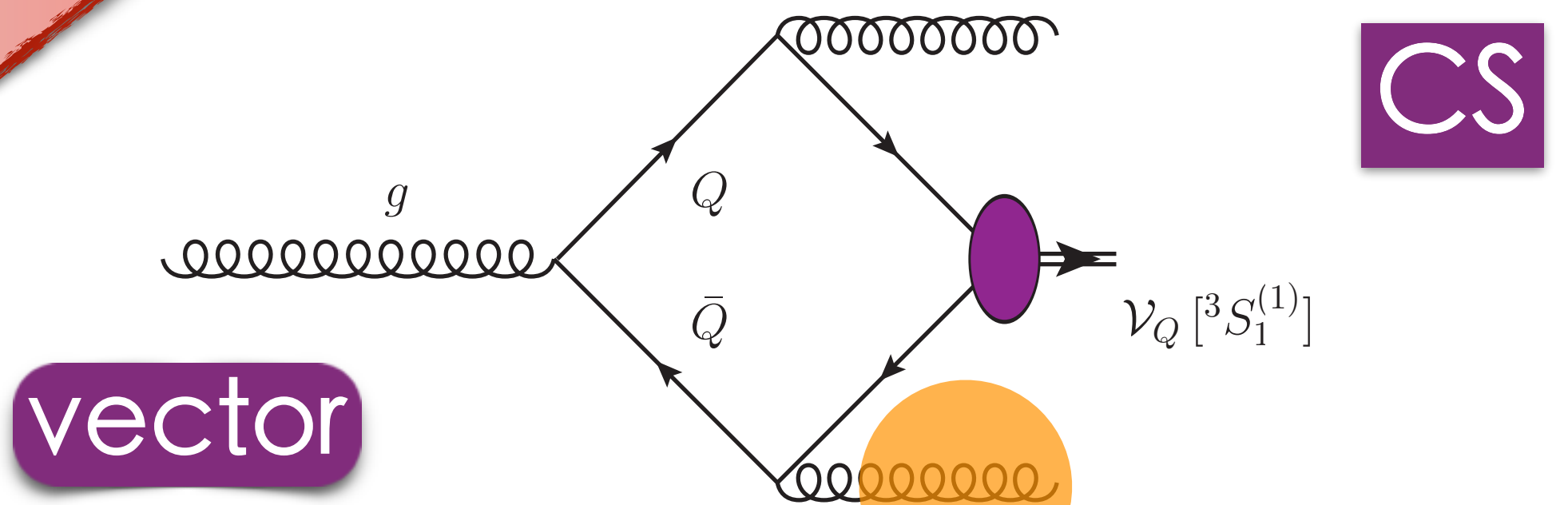
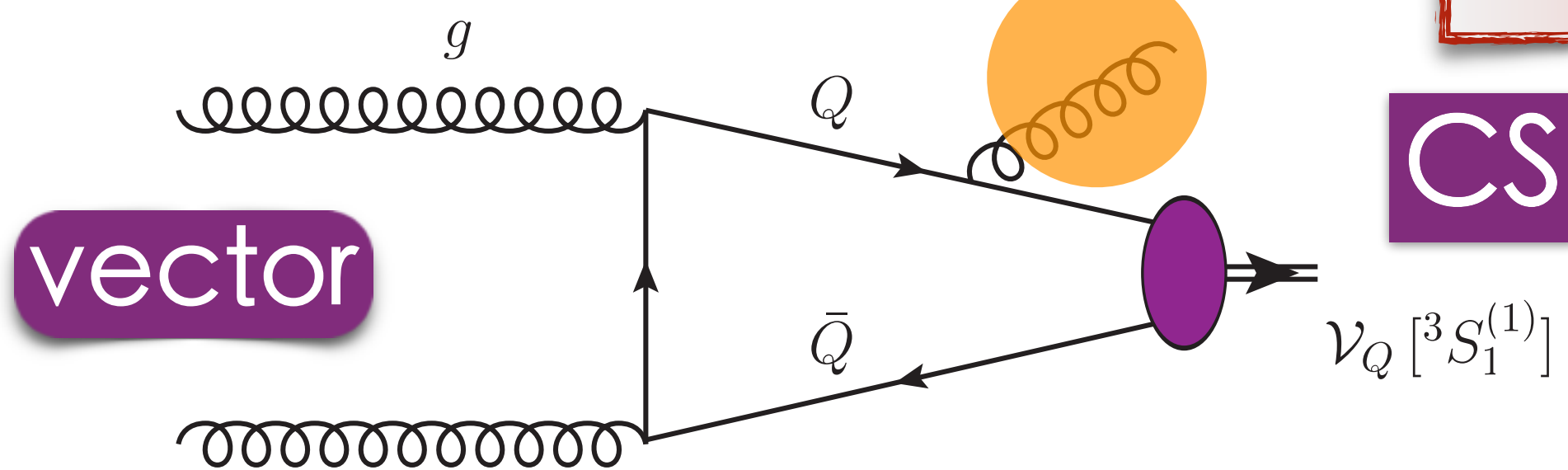
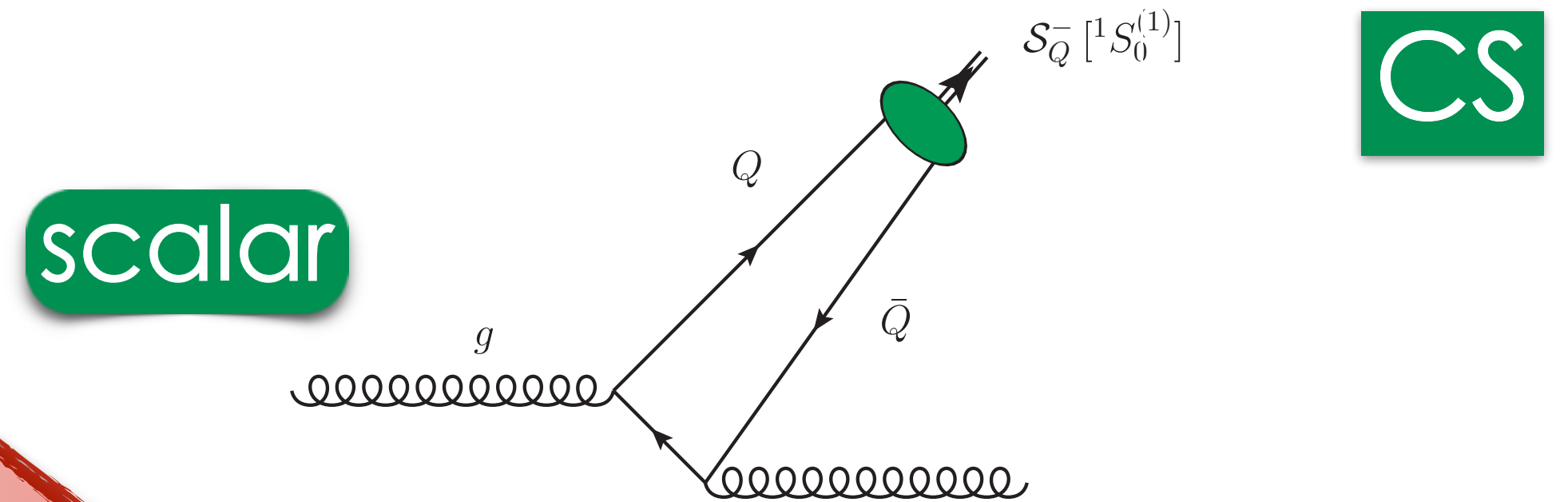


# From low energies to high energies

Low energy, low  $p_T$   
Short-distance production



High energy, high  $p_T$   
Single-parton fragmentation



$p_T \gtrsim 10 \div 15 \text{ GeV}$   
(charmonia)

3

Quarkonium  
fragmentation  
from **HF-NRevo**

# Heavy-Flavor Non-Relativistic evolution

**HADRONIC STRUCTURE**

**QUARKONIUM THEORY**

# Heavy-Flavor Non-Relativistic evolution

**HADRONIC STRUCTURE**

**QUARKONIUM THEORY**

**PRECISION QCD**

**COLLINEAR FACTORIZATION**

# Heavy-Flavor Non-Relativistic evolution

HADRONIC STRUCTURE  
QUARKONIUM THEORY

PRECISION QCD  
COLLINEAR FACTORIZATION

Guiding principle  $\Rightarrow$  ; Use the [best of the Two Worlds](#) as much as we can !

# Heavy-Flavor Non-Relativistic evolution

**HF-NRevo**

Interpretation

3.1 The best of the Two Worlds



# Heavy-Flavor Non-Relativistic evolution

**HF-NRevo**

Interpretation

Evolution

3.1 The best of the Two Worlds

# Heavy-Flavor Non-Relativistic evolution

**HF-NRevo**

Interpretation

Evolution

Uncertainties

3.1 The best of the Two Worlds

## HF-NRevo

Interpretation

Evolution

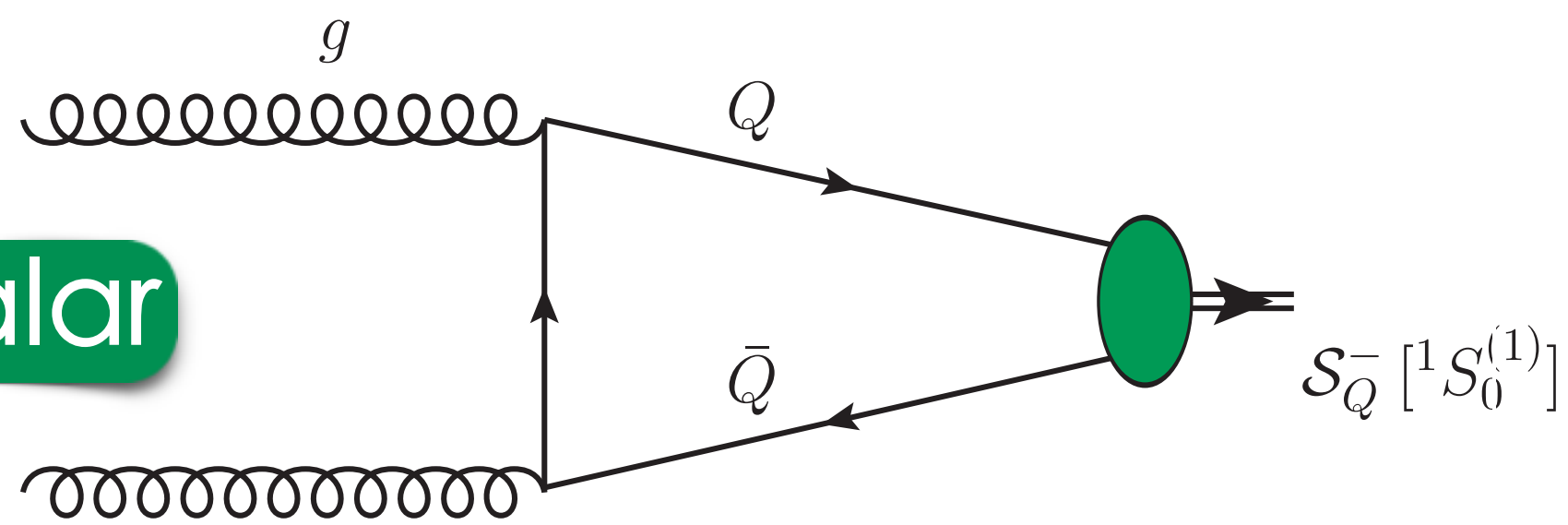
Uncertainties

- NRQCD  $\Rightarrow$  proxy for initial-scale FF inputs
- A heavy-flavor-scheme based vision
- Low vs large  $p_T \Rightarrow$  FFNS vs VFNS fragmentation

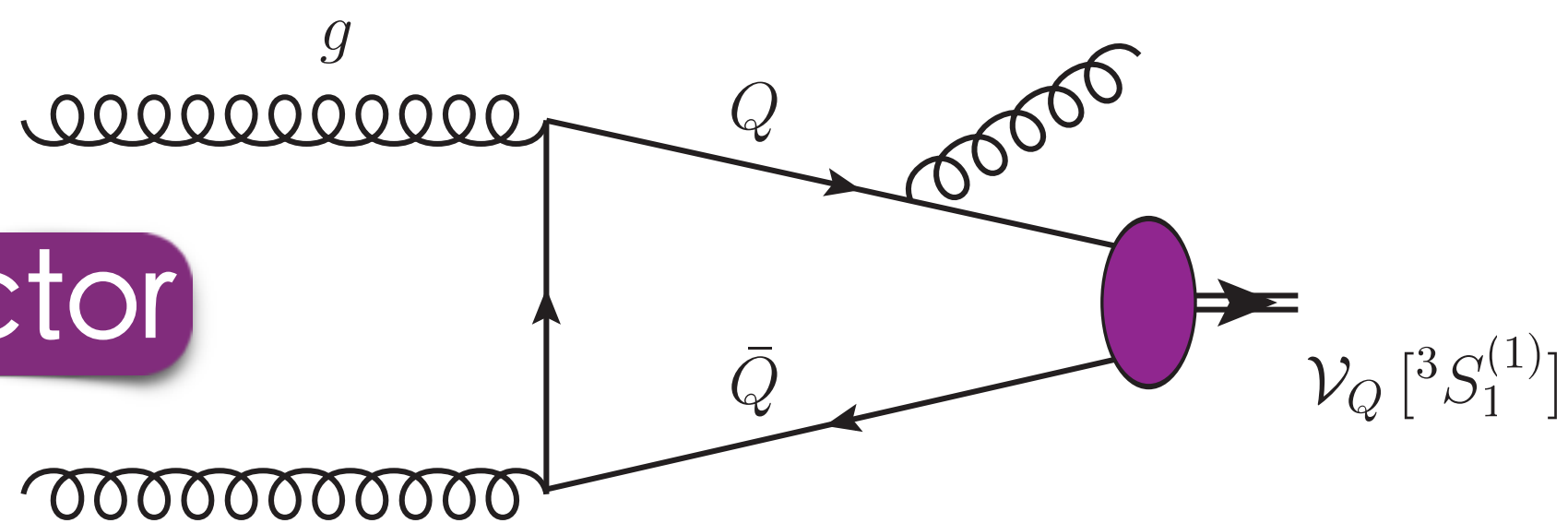
# From low energies to high energies

Low  $p_T \Rightarrow$  two-parton FFs  
Genuine higher-twist FFNS FFs

scalar

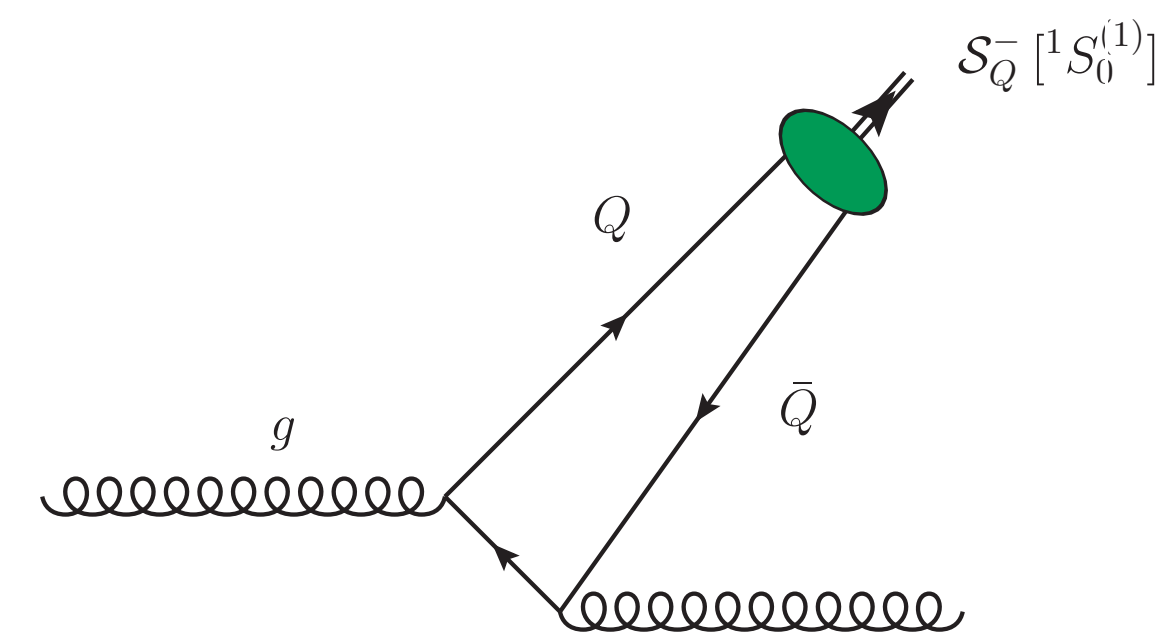


vector

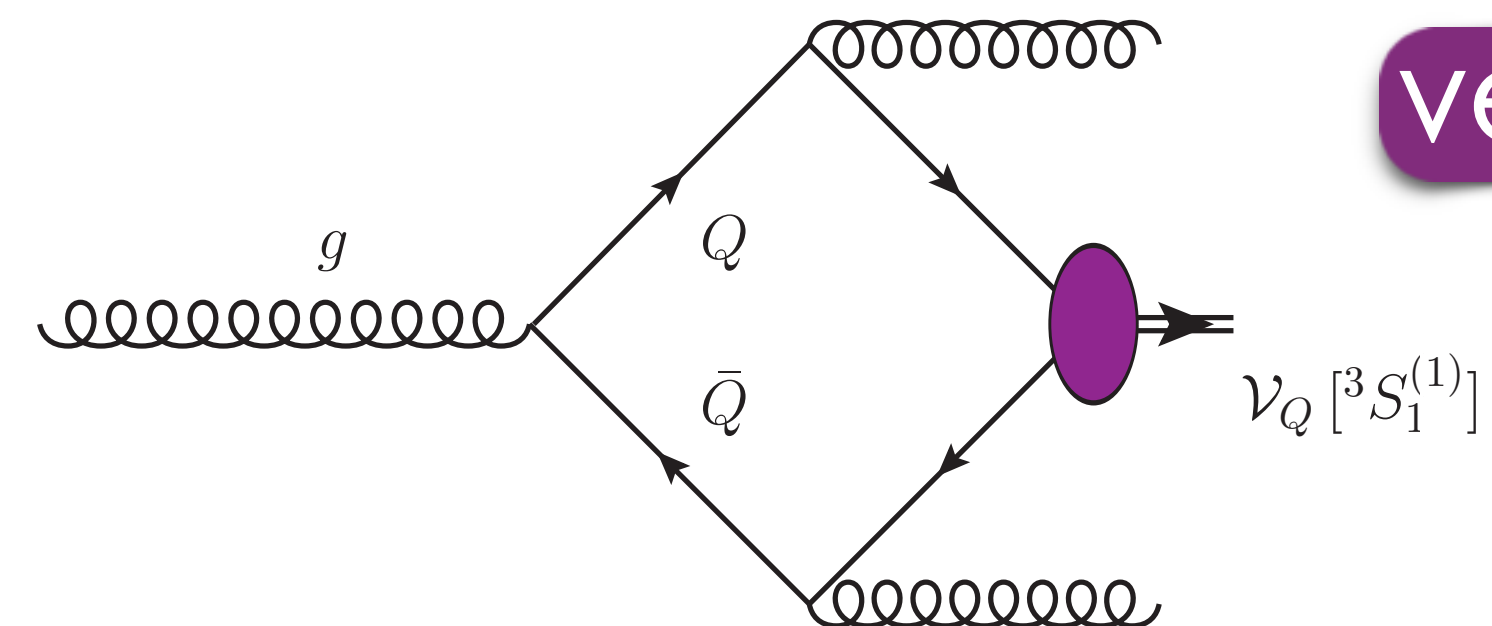


High  $p_T \Rightarrow$  single-parton FFs  
Twist-2 VFNS FFs + power corrections

scalar



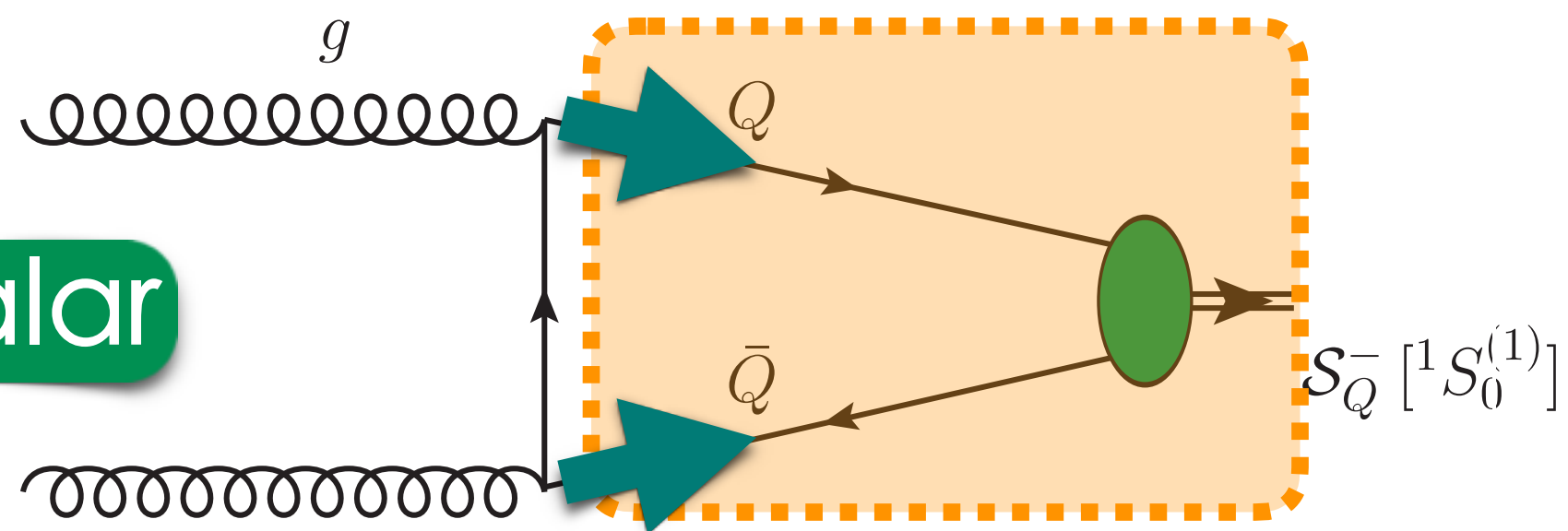
vector



# From low energies to high energies

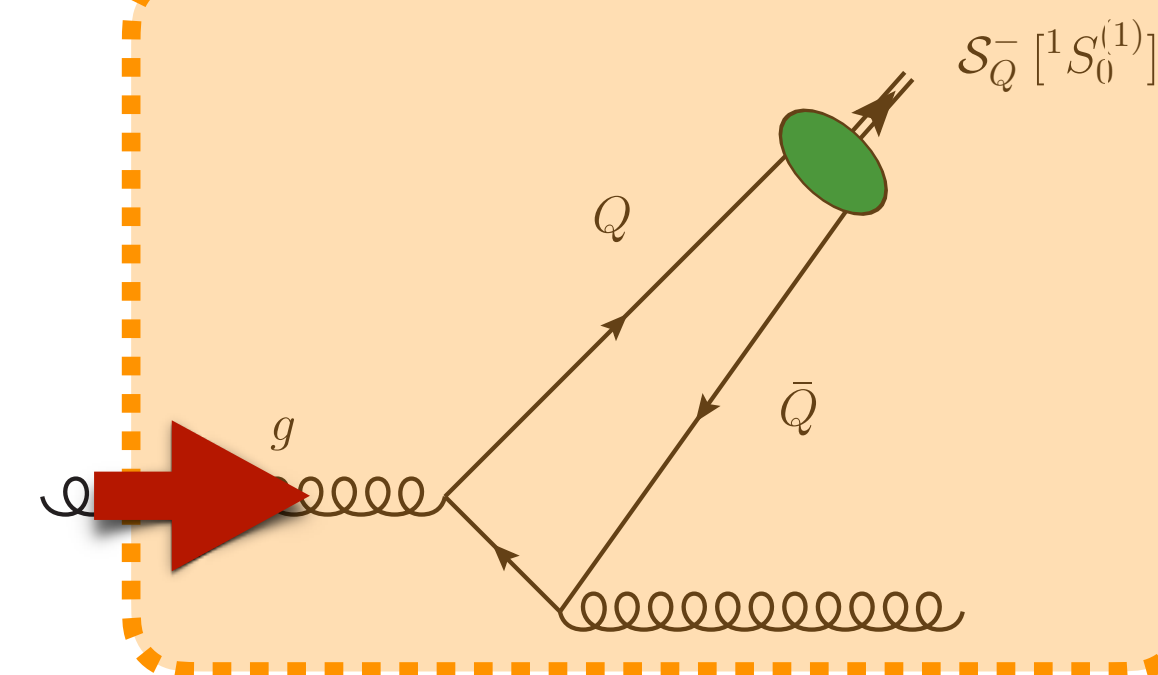
Low  $p_T \Rightarrow$  two-parton FFs  
Genuine higher-twist FFNS FFs

scalar

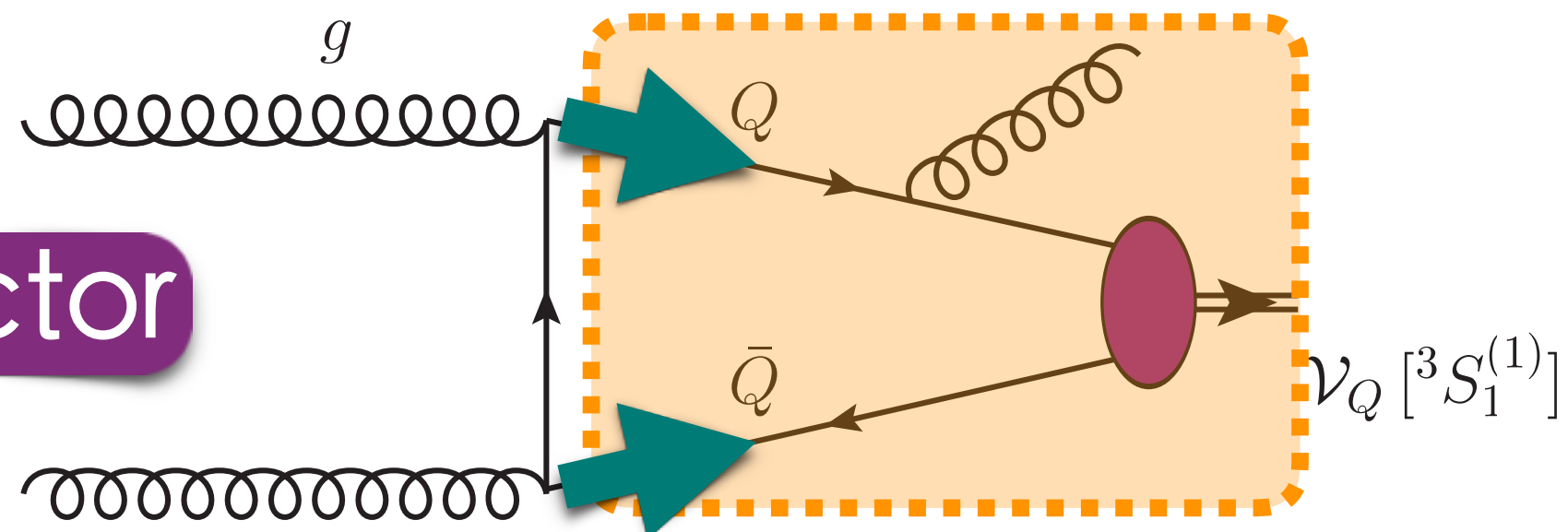


High  $p_T \Rightarrow$  single-parton FFs  
Twist-2 VFNS FFs + power corrections

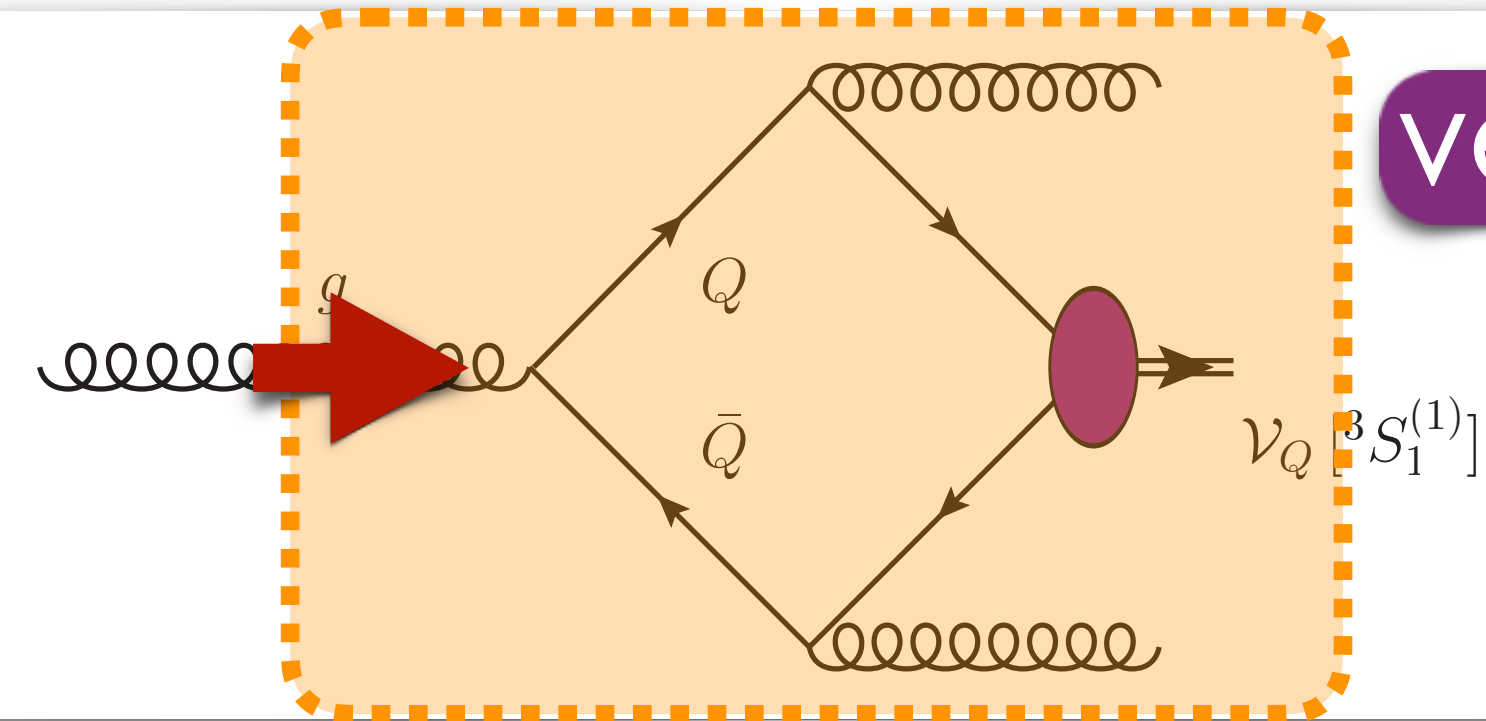
scalar



vector



vector



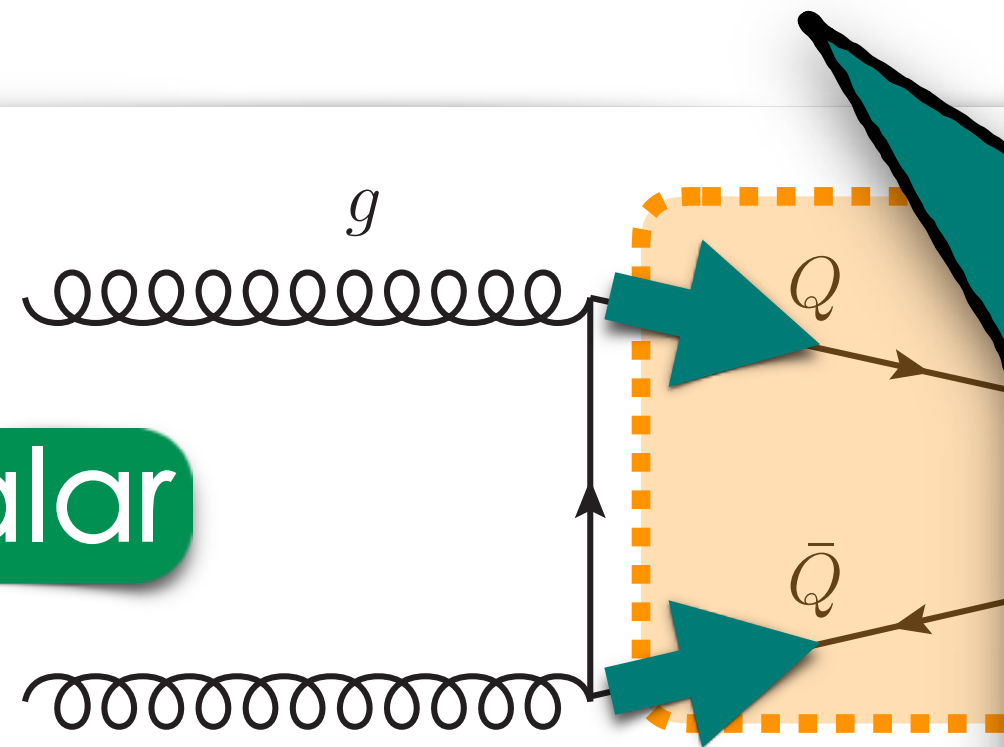
# From low energies to high energies

Low  $p_T \Rightarrow$  two-parton FFs  
Genuine higher-twist FFNS FFs

High  $p_T \Rightarrow$  single-parton FFs  
Twist-2 VFNS FFs + power corrections

## TMD ShFs vs TMD FFs

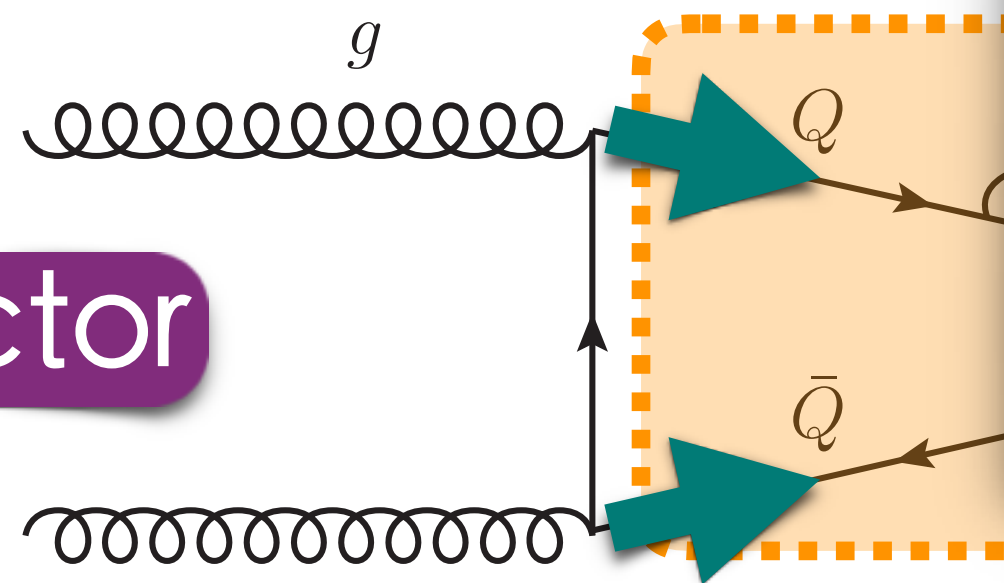
scalar



Matching tails  $\Rightarrow$  different divergent behaviors

[D. Boer, J. Bor, L. Maxia, C. Pisano, F. Yuan (2023)]

vector



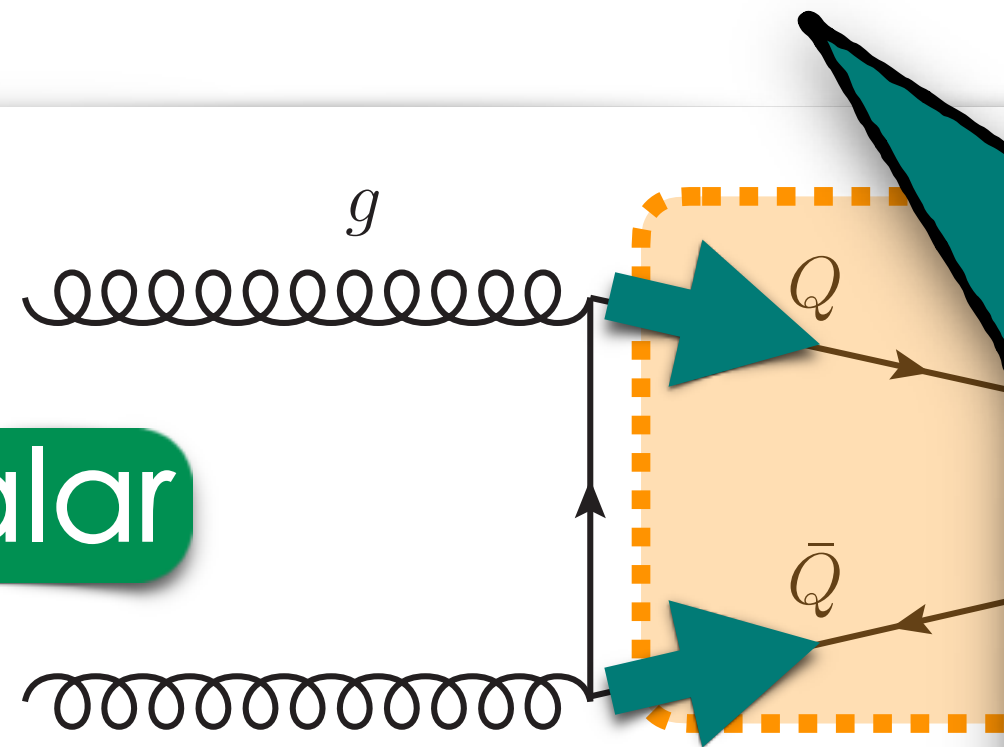
# From low energies to high energies

Low  $p_T \Rightarrow$  two-parton FFs  
Genuine higher-twist FFNS FFs

High  $p_T \Rightarrow$  single-parton FFs  
Twist-2 VFNS FFs + power corrections

## TMD ShFs vs TMD FFs

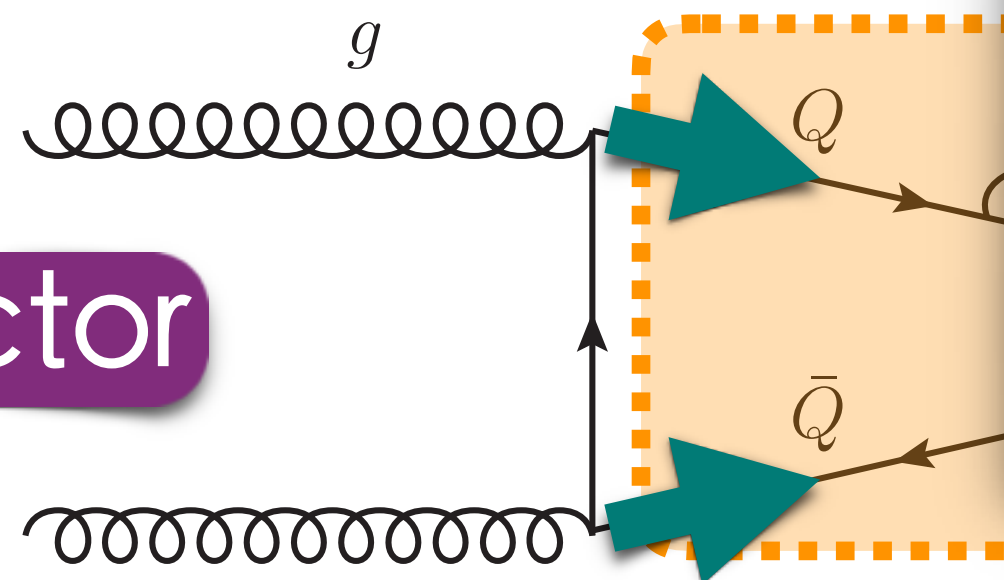
scalar



- Matching tails  $\Rightarrow$  different divergent behaviors

[D. Boer, J. Bor, L. Maxia, C. Pisano, F. Yuan (2023)]

vector

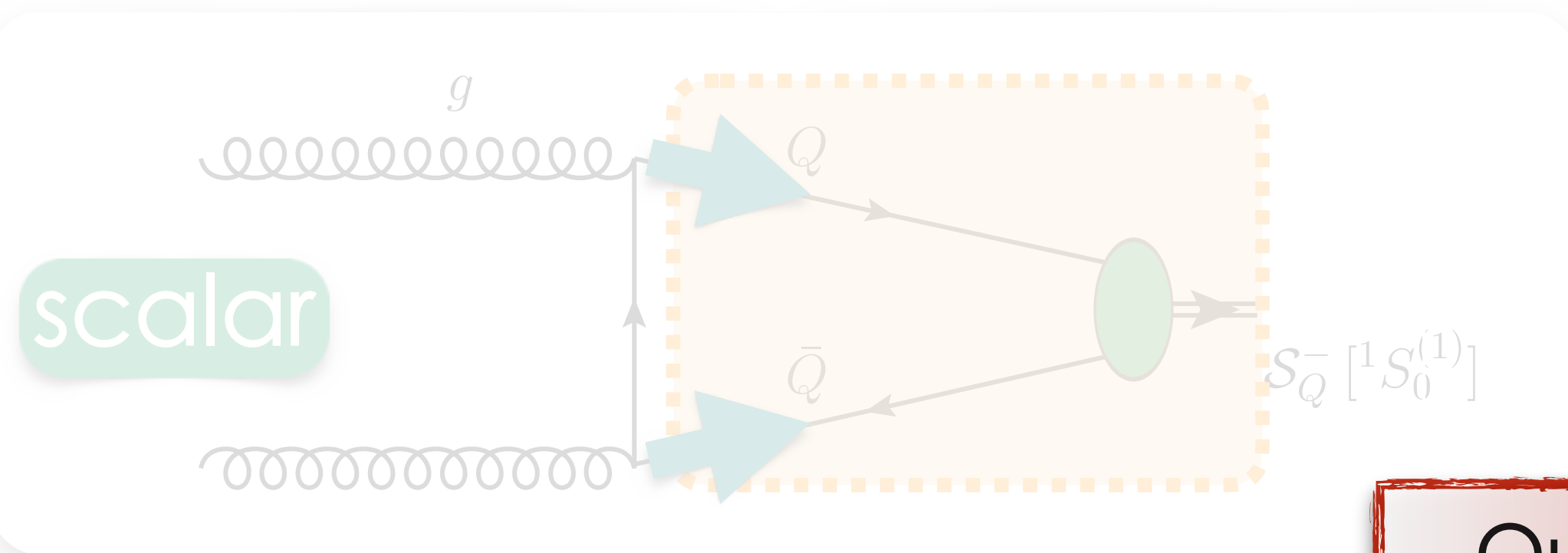


- Studies on QCD factorization in progress

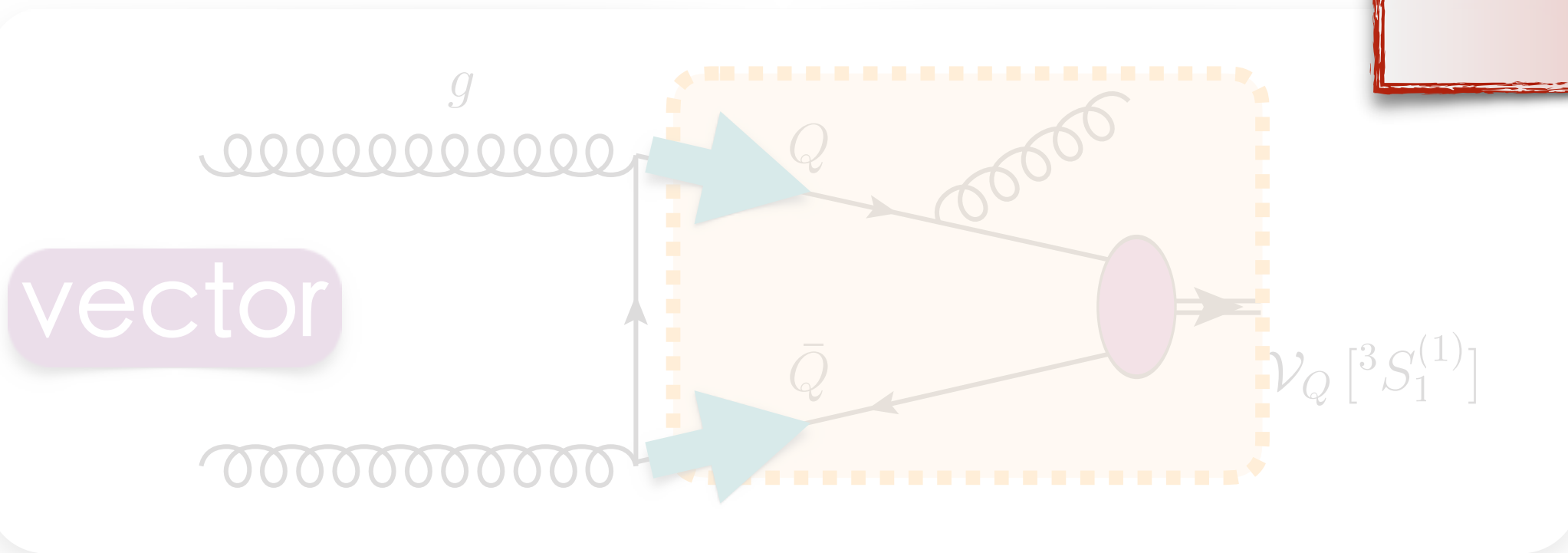
[K. Lee, J.-W. Qiu, J. Sterman, K. Watanabe (2022)]

# From low energies to high energies

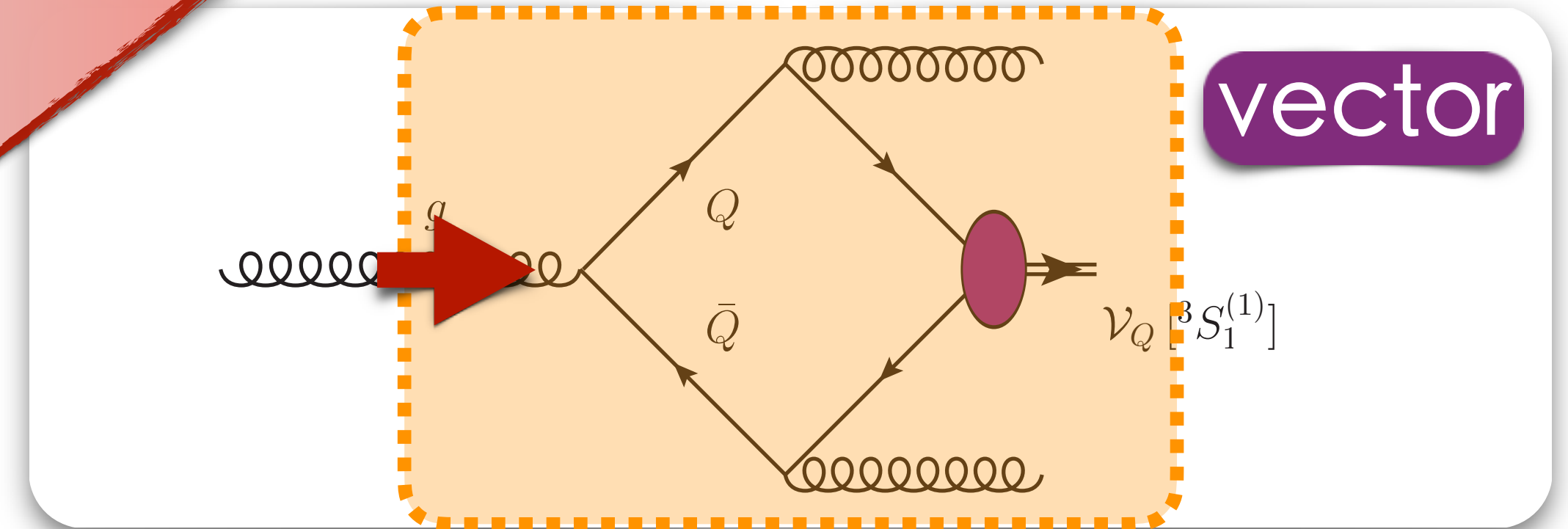
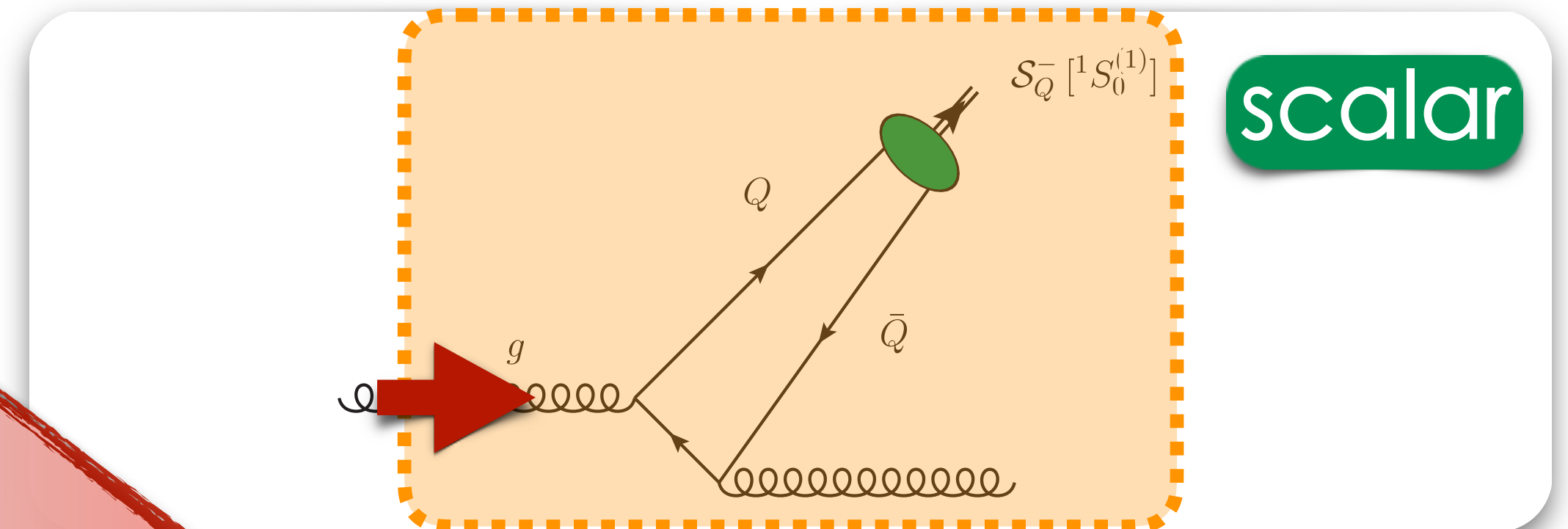
Low  $p_T \Rightarrow$  two-parton FFs  
Genuine higher-twist FFNS FFs



Our study & goal



High  $p_T \Rightarrow$  single-parton FFs  
Twist-2 VFNS FFs + power corrections





# Heavy-Flavor Non-Relativistic evolution

## HF-NRevo

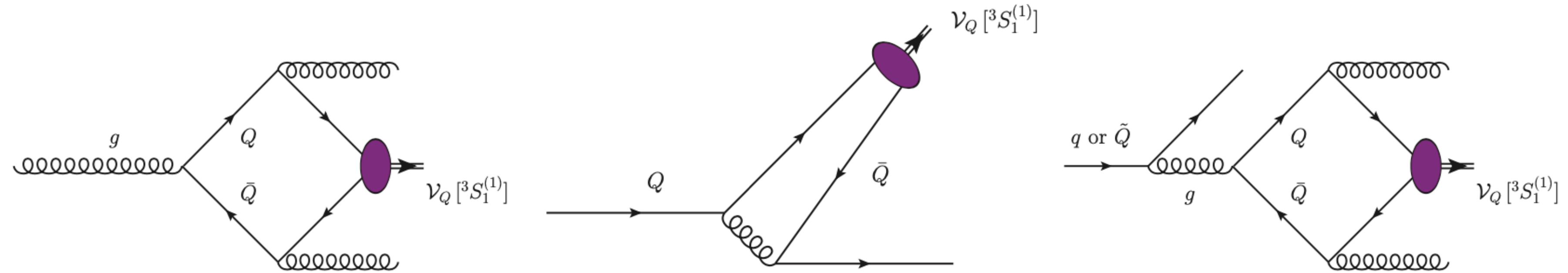
Interpretation

Evolution

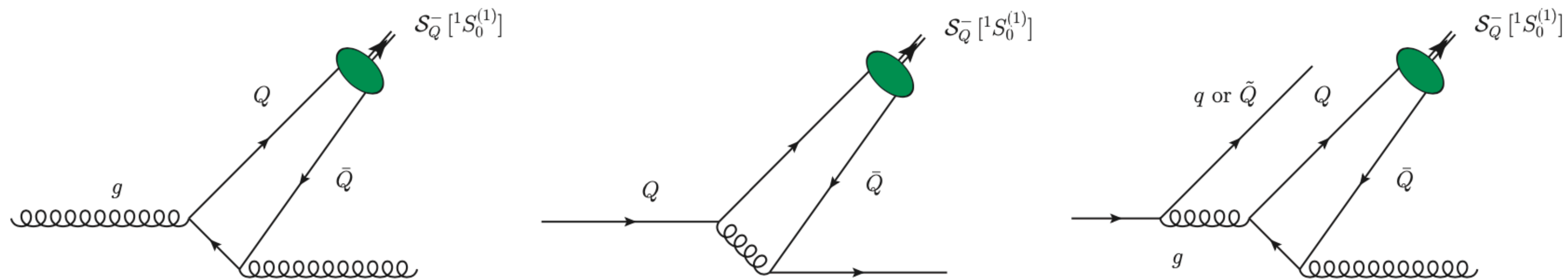
Uncertainties

- Proper DGLAP collinear evolution
- Thresholds at work for all partons
- Two-step strategy  $\Rightarrow$  EDevo  $\otimes$  ADevo

# HF-NRevo: Initial-scale NRCQD inputs

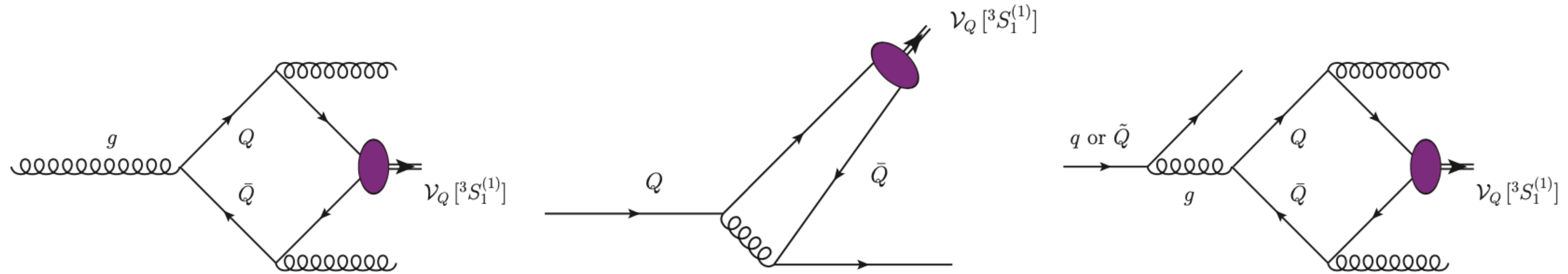


**Fig. 1** Left panel: a leading diagram for the fragmentation of a gluon to  $\mathcal{V}_Q [^3S_1^{(1)}]$  at  $\mathcal{O}(\alpha_s^3)$ . Central panel: one of the leading diagrams for the fragmentation of a constituent heavy quark ( $Q$ ) to a  $S$ -wave color singlet vector quarkonium  $\mathcal{V}_Q [^3S_1^{(1)}]$  at  $\mathcal{O}(\alpha_s^2)$ . Right panel: a leading diagram for the fragmentation of a nonconstituent light ( $q$ ) or heavy ( $\tilde{Q}$ ) quark to  $\mathcal{V}_Q [^3S_1^{(1)}]$  at  $\mathcal{O}(\alpha_s^4)$ . Violet blobs refer to the  $\mathcal{V}_Q [^3S_1^{(1)}]$  nonperturbative NRQCD LDME.

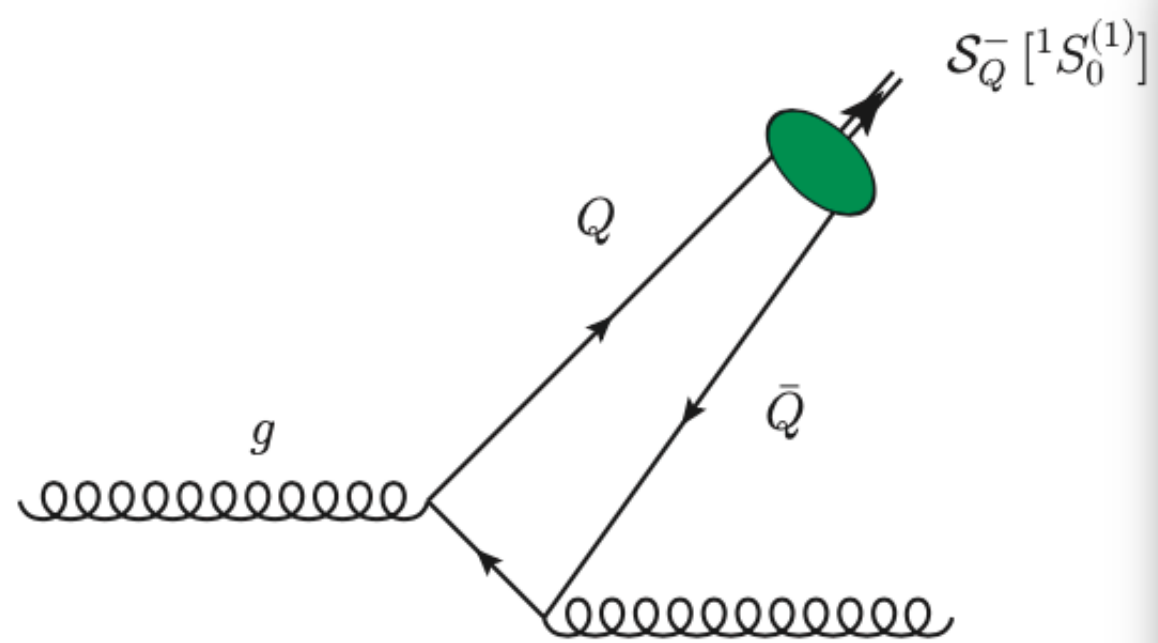


**Fig. 2** Left panel: a leading diagram for the fragmentation of a gluon to  $\mathcal{S}_Q^- [^1S_0^{(1)}]$  at  $\mathcal{O}(\alpha_s^2)$ . Central panel: one of the leading diagrams for the fragmentation of a constituent heavy quark ( $Q$ ) to a  $S$ -wave color singlet pseudoscalar quarkonium  $\mathcal{S}_Q^- [^1S_0^{(1)}]$  at  $\mathcal{O}(\alpha_s^2)$ . Right panel: a leading diagram for the fragmentation of a nonconstituent light ( $q$ ) or heavy ( $\tilde{Q}$ ) quark to  $\mathcal{S}_Q^- [^1S_0^{(1)}]$  at  $\mathcal{O}(\alpha_s^3)$ . Green blobs refer to the  $\mathcal{S}_Q^- [^1S_0^{(1)}]$  nonperturbative NRQCD LDME.

# HF-NRevo: Initial-scale NRCQD inputs



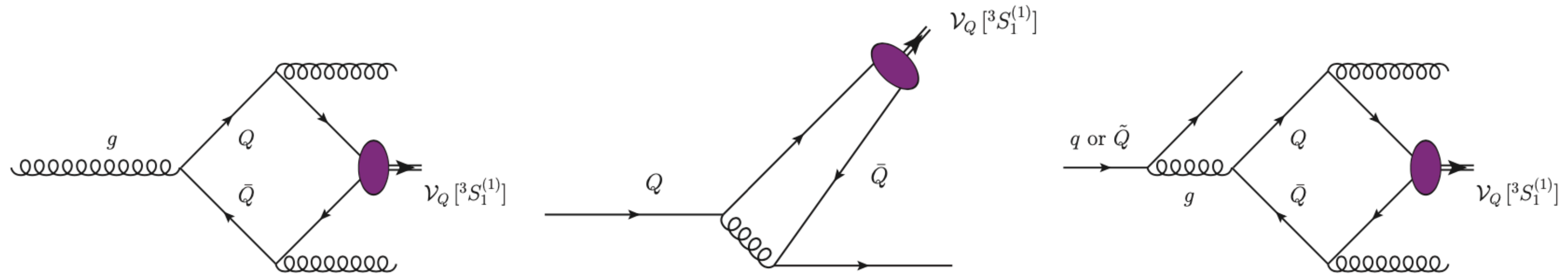
**Fig. 1** Left panel: a leading diagram for the fragmentation of a gluon to  $\mathcal{V}_Q [^3S_1^{(1)}]$  at  $\mathcal{O}(\alpha_s^3)$ . Central panel: one of the leading diagrams for the fragmentation of a constituent heavy quark ( $Q$ ) to a  $S$ -wave color singlet vector quarkonium  $\mathcal{V}_Q [^3S_1^{(1)}]$  at  $\mathcal{O}(\alpha_s^2)$ . Right panel: a leading diagram for the fragmentation of a nonconstituent light ( $q$ ) or heavy ( $\tilde{Q}$ ) quark to  $\mathcal{V}_Q [^3S_1^{(1)}]$  at  $\mathcal{O}(\alpha_s^4)$ . Violet blobs refer to the  $\mathcal{V}_Q [^3S_1^{(1)}]$  nonperturbative NRQCD LDME.



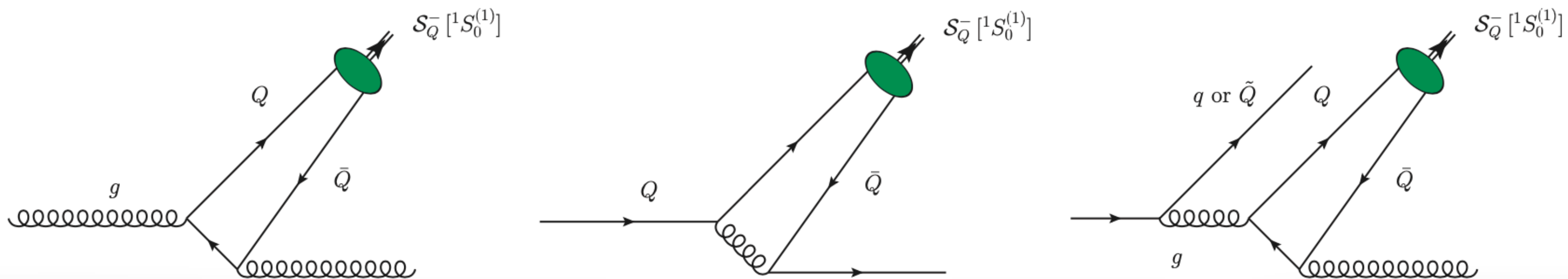
**Fig. 2** Left panel: a leading diagram for leading diagrams for the fragmentation of  $S_Q^- [^1S_0^{(1)}]$  at  $\mathcal{O}(\alpha_s^2)$ . Right panel: a leading diagram for the fragmentation of a constituent heavy quark ( $Q$ ) to  $S_Q^- [^1S_0^{(1)}]$  at  $\mathcal{O}(\alpha_s^3)$ . Green blobs refer to the  $S_Q^- [^1S_0^{(1)}]$  nonperturbative NRQCD LDME.

Quarkonium ( $\mathcal{Q}$ )	$g \rightarrow \mathcal{Q}$	$Q \rightarrow \mathcal{Q}$	$q \text{ or } \tilde{Q} \rightarrow \mathcal{Q}$
$\mathcal{Q} \equiv \mathcal{V}_Q [^1S_0^{(1)}] \equiv J/\psi, \Upsilon$	$-\$ $\mathcal{O}(\alpha_s^3) \equiv \text{NLO}$ $\mathcal{O}(\alpha_s^4) \equiv \text{NNLO}$ $\vdots$	$\mathcal{O}(\alpha_s^2) \equiv \text{LO}$ $\mathcal{O}(\alpha_s^3) \equiv \text{NLO}$ $\mathcal{O}(\alpha_s^4) \equiv \text{NNLO}$ $\vdots$	$-\$ $-\$ $\mathcal{O}(\alpha_s^4) \equiv \text{NNLO}$ $\vdots$
$\mathcal{Q} \equiv S_Q^- [^3S_1^{(1)}] \equiv \eta_c, \eta_b$	$\mathcal{O}(\alpha_s^2) \equiv \text{LO}$ $\mathcal{O}(\alpha_s^3) \equiv \text{NLO}$ $\mathcal{O}(\alpha_s^4) \equiv \text{NNLO}$ $\vdots$	$\mathcal{O}(\alpha_s^2) \equiv \text{LO}$ $\mathcal{O}(\alpha_s^3) \equiv \text{NLO}$ $\mathcal{O}(\alpha_s^4) \equiv \text{NNLO}$ $\vdots$	$-\$ $\mathcal{O}(\alpha_s^3) \equiv \text{NLO}$ $\mathcal{O}(\alpha_s^4) \equiv \text{NNLO}$ $\vdots$

# HF-NRevo: Initial-scale NRCQD inputs

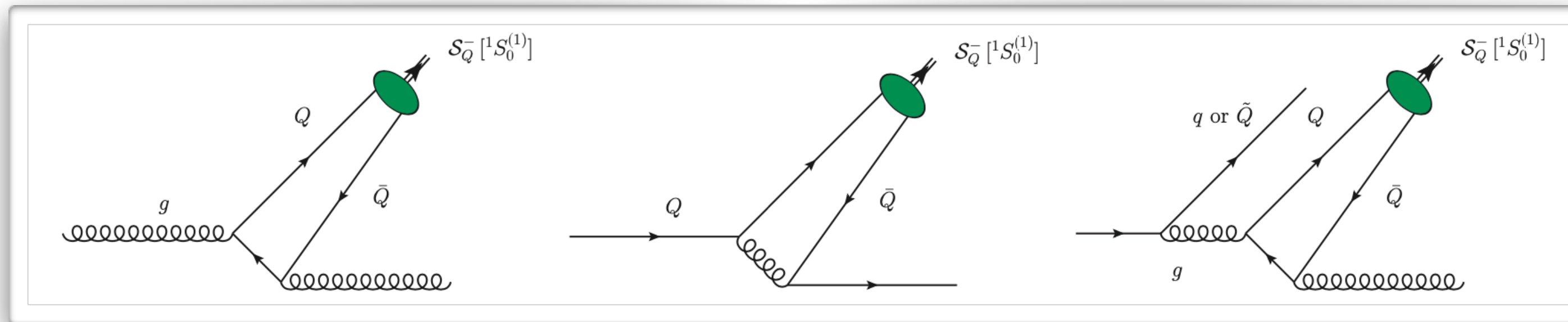


**Fig. 1** Left panel: a leading diagram for the fragmentation of a gluon to  $\mathcal{V}_Q [{}^3S_1^{(1)}]$  at  $\mathcal{O}(\alpha_s^3)$ . Central panel: one of the leading diagrams for the fragmentation of a constituent heavy quark ( $Q$ ) to a  $S$ -wave color singlet vector quarkonium  $\mathcal{V}_Q [{}^3S_1^{(1)}]$  at  $\mathcal{O}(\alpha_s^2)$ . Right panel: a leading diagram for the fragmentation of a nonconstituent light ( $q$ ) or heavy ( $\bar{Q}$ ) quark to  $\mathcal{V}_Q [{}^3S_1^{(1)}]$  at  $\mathcal{O}(\alpha_s^4)$ . Violet blobs refer to the  $\mathcal{V}_Q [{}^3S_1^{(1)}]$  nonperturbative NRQCD LDME.



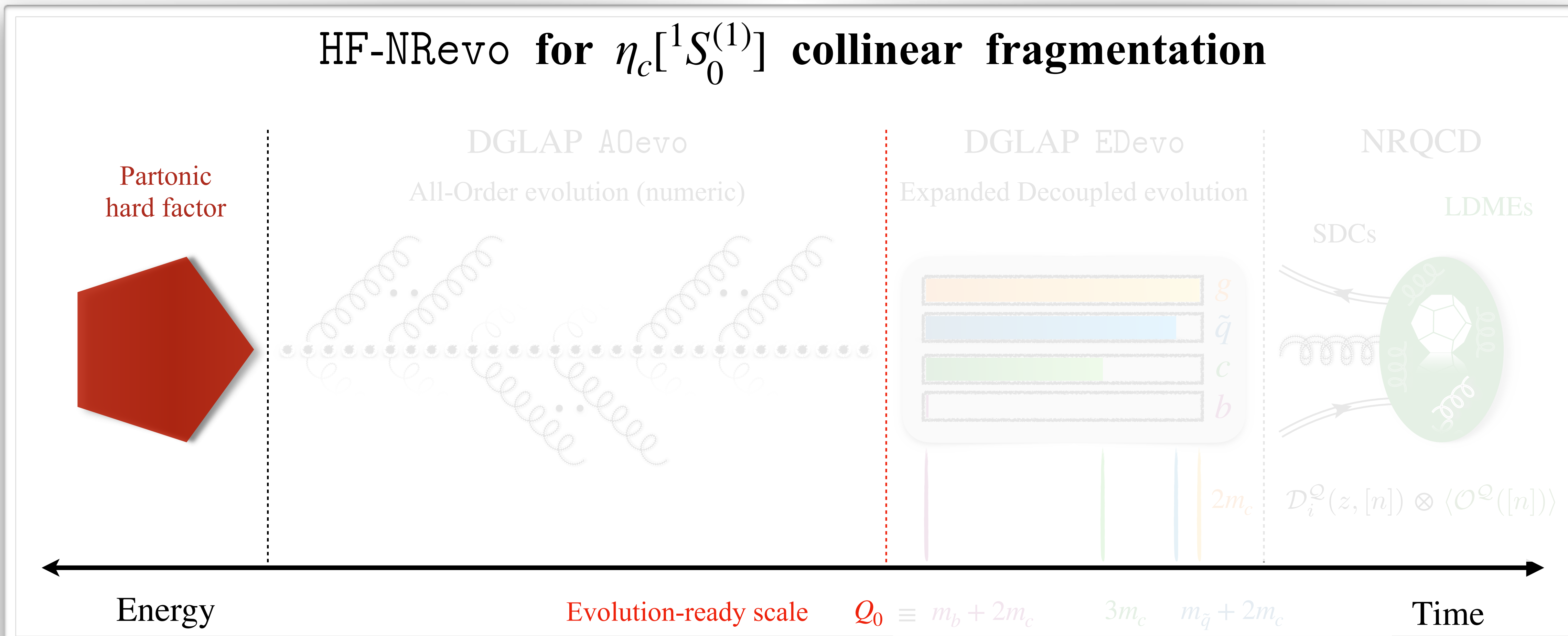
$\mathcal{S}_Q^- [{}^1S_0^{(1)}]$ quarkonium	$\mu_{F,0}(g \rightarrow \mathcal{S}_Q^-)$	$\mu_{F,0}(d, u, s \rightarrow \mathcal{S}_Q^-)$	$\mu_{F,0}(Q \rightarrow \mathcal{S}_Q^-)$	$\mu_{F,0}(\bar{Q} \rightarrow \mathcal{S}_Q^-)$	$Q_0 \equiv \max(\{\mu_{F,0}\})$
$\eta_c$	$2m_c$	$m_{d,u,s} + 2m_c$	$3m_c$	$m_b + 2m_c$	$m_b + 2m_c$
$\eta_b$	$2m_b$	$m_{d,u,s} + 2m_b$	$3m_b$	$m_c + 2m_b$	$3m_b$

# HF-NRevo: Initial-scale NRCQD inputs

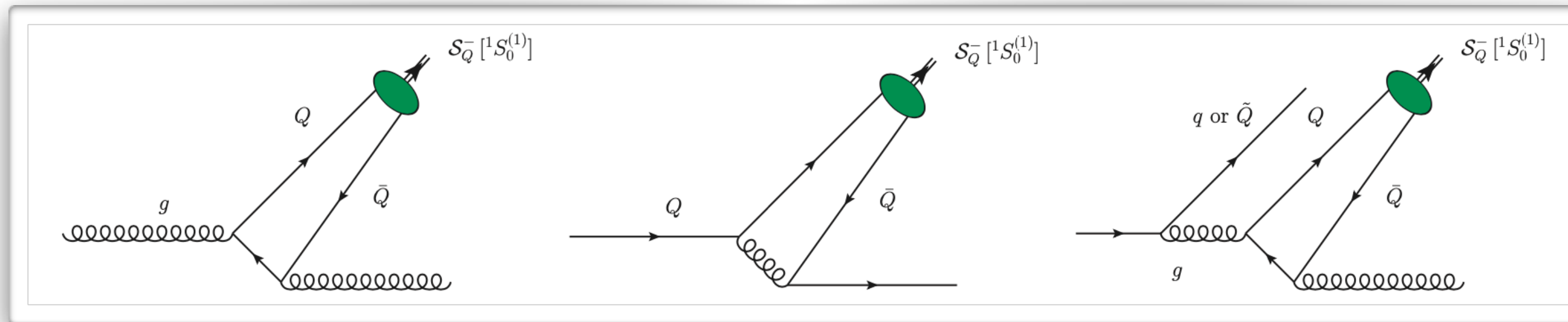


Scalar  $\eta_c$

## HF-NRevo for $\eta_c[{}^1S_0^{(1)}]$ collinear fragmentation

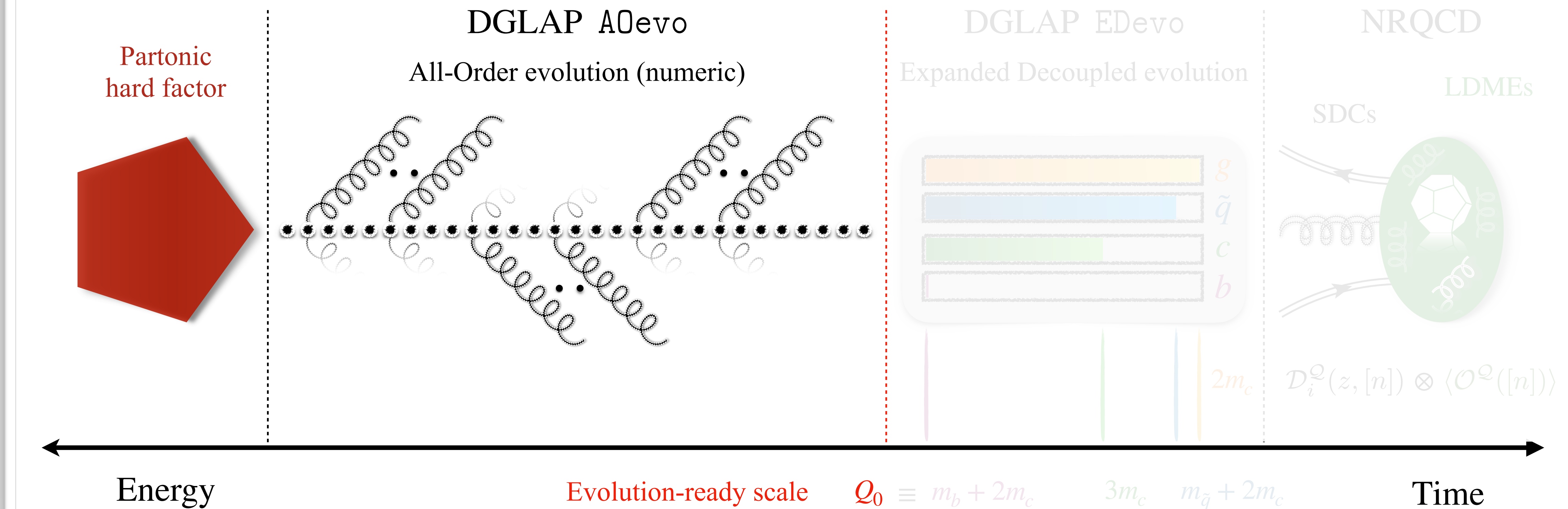


# HF-NRevo: Initial-scale NRCQD inputs

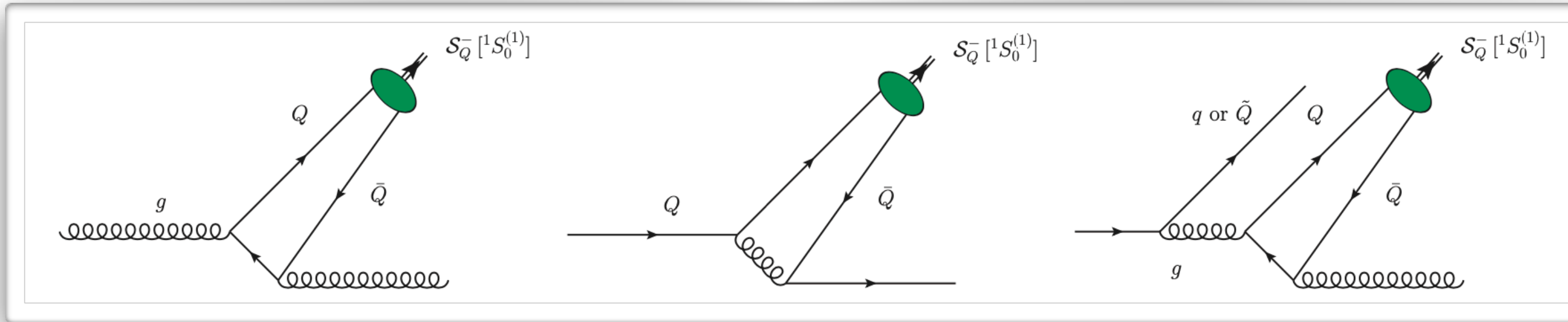


Scalar  $\eta_c$

## HF-NRevo for $\eta_c[{}^1S_0^{(1)}]$ collinear fragmentation

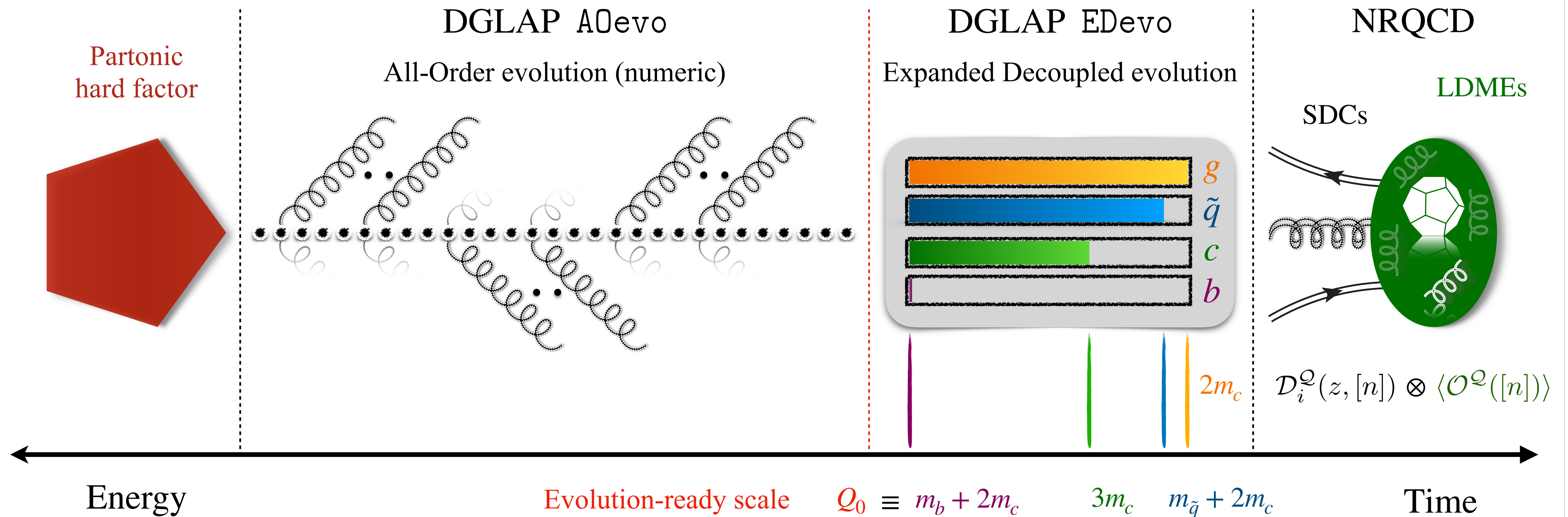


# HF-NRevo: Initial-scale NRCQD inputs

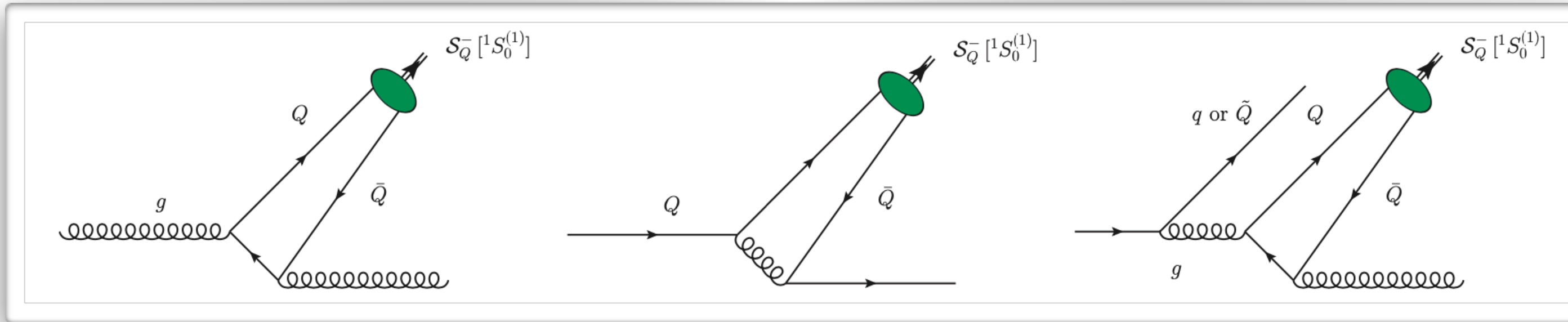


Scalar  $\eta_c$

## HF-NRevo for $\eta_c[{}^1S_0^{(1)}]$ collinear fragmentation

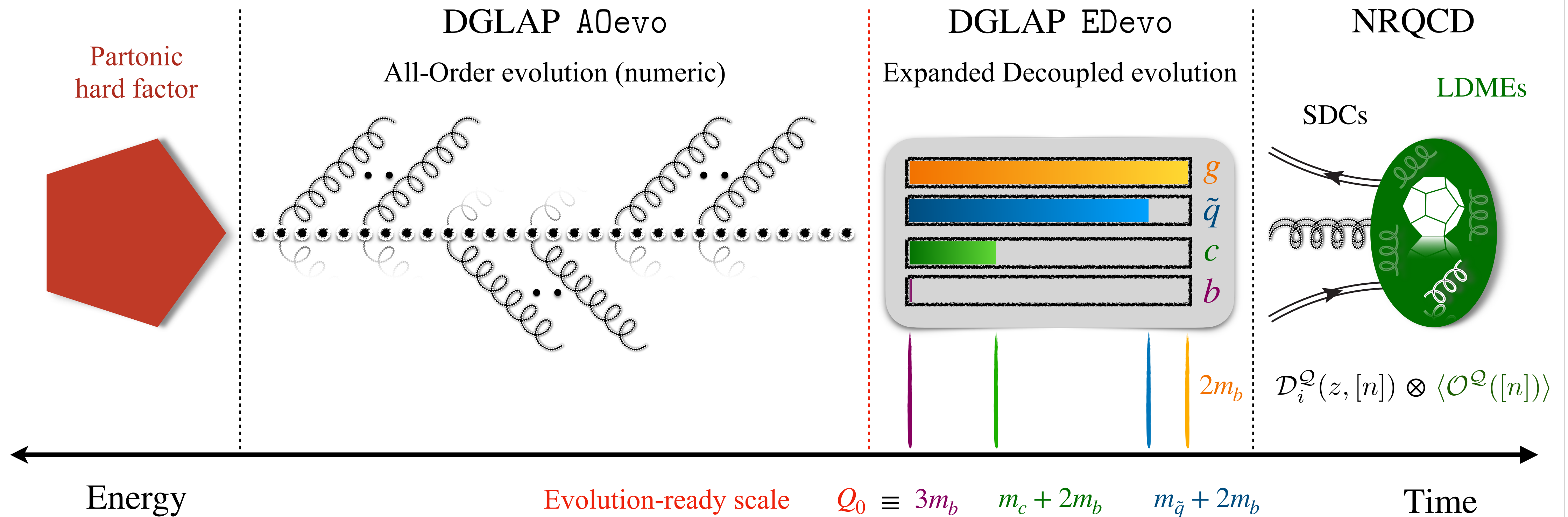


# HF-NRevo: Initial-scale NRCQD inputs



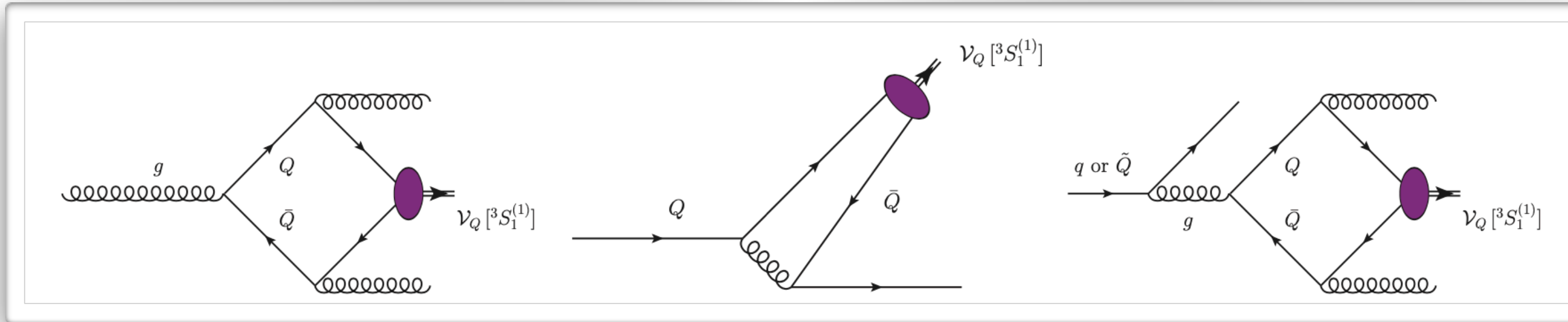
Scalar  $\eta_b$

## HF-NRevo for $\eta_b[^1S_0^{(1)}]$ collinear fragmentation



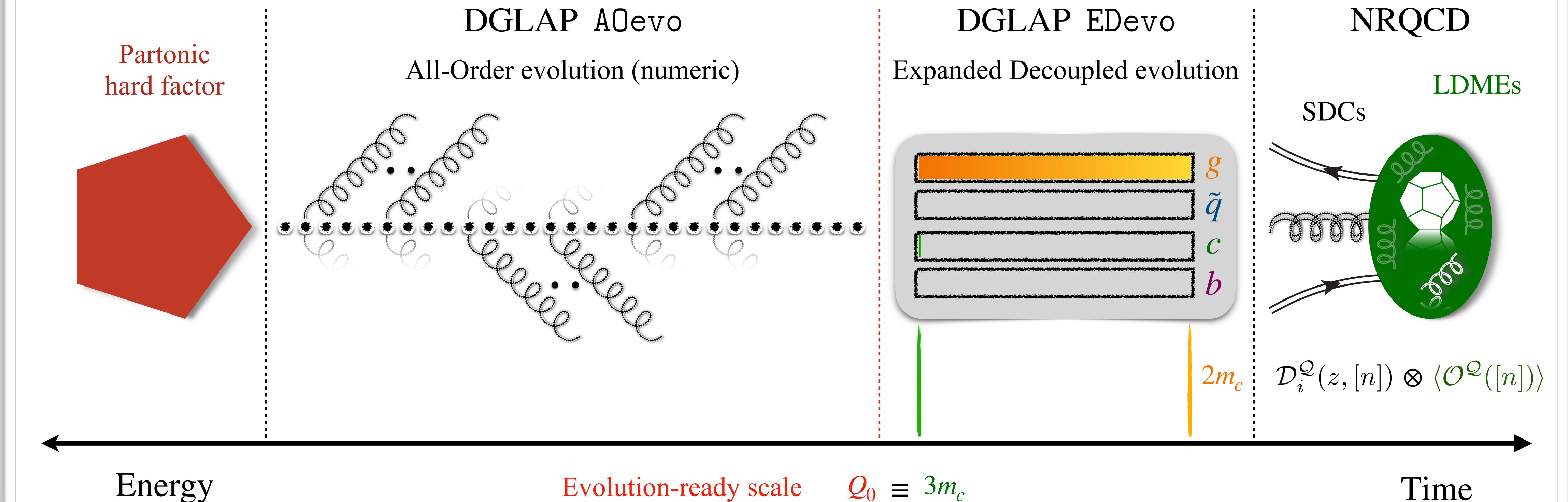


# HF-NRevo: Initial-scale NRCQD inputs

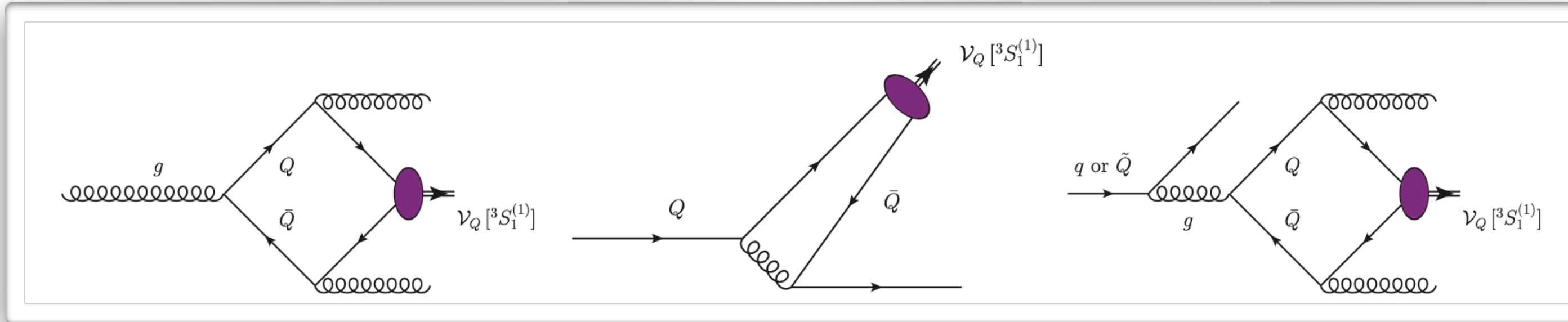


Vector  $J/\psi$

## HF-NRevo for $J/\psi[{}^3S_1^{(1)}]$ collinear fragmentation

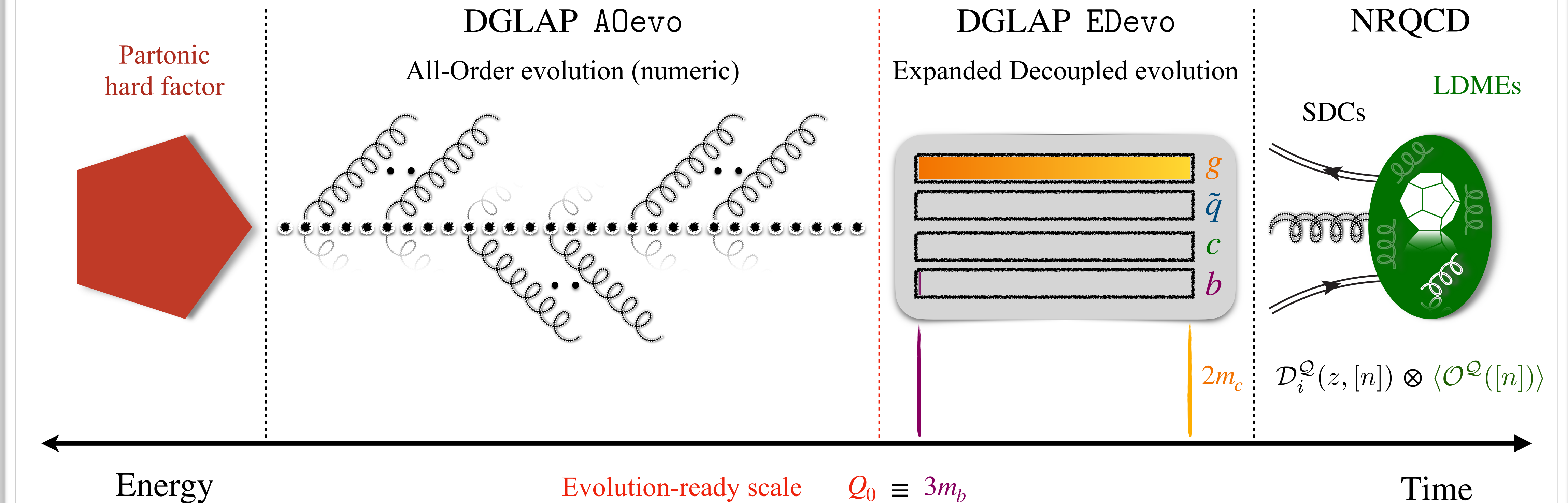


# HF-NRevo: Initial-scale NRCQD inputs



Vector  $\Upsilon$

## HF-NRevo for $\Upsilon[{}^3S_1^{(1)}]$ collinear fragmentation






# Heavy-Flavor Non-Relativistic evolution

## HF-NRevo

Interpretation

Evolution

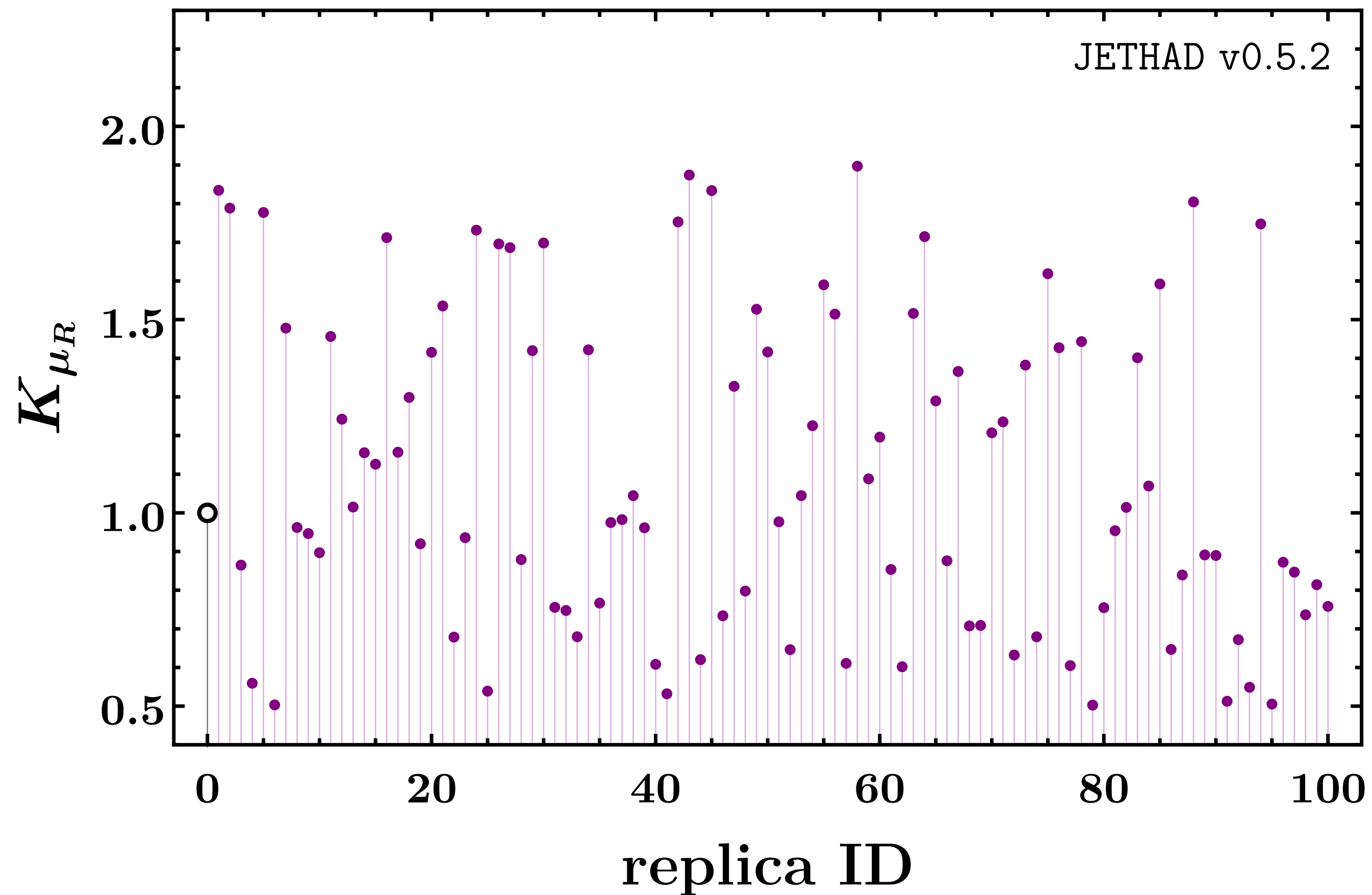
Uncertainties

- Initial-scale MHOUs  $\Rightarrow$  first systematic analysis
- Idea  $\Leftrightarrow$  **ThCovM**   & **MCscales**  MHOUs
- Future  $\Leftarrow$  extraction of NP LDMEs from data

# Towards NREF1.0: MHOU-replica analysis

Vector quarkonia

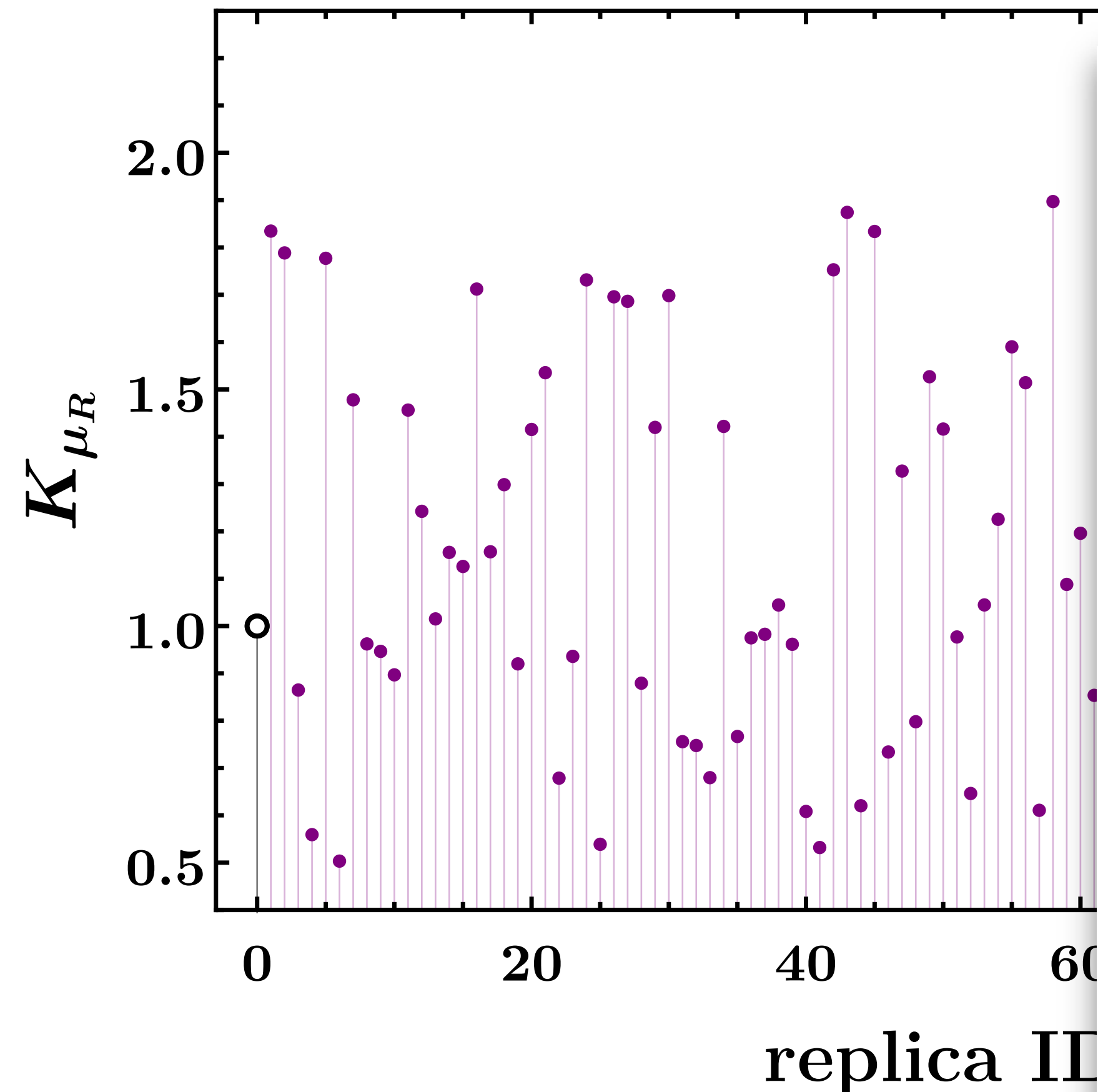
Evolution-ready renormalization scale



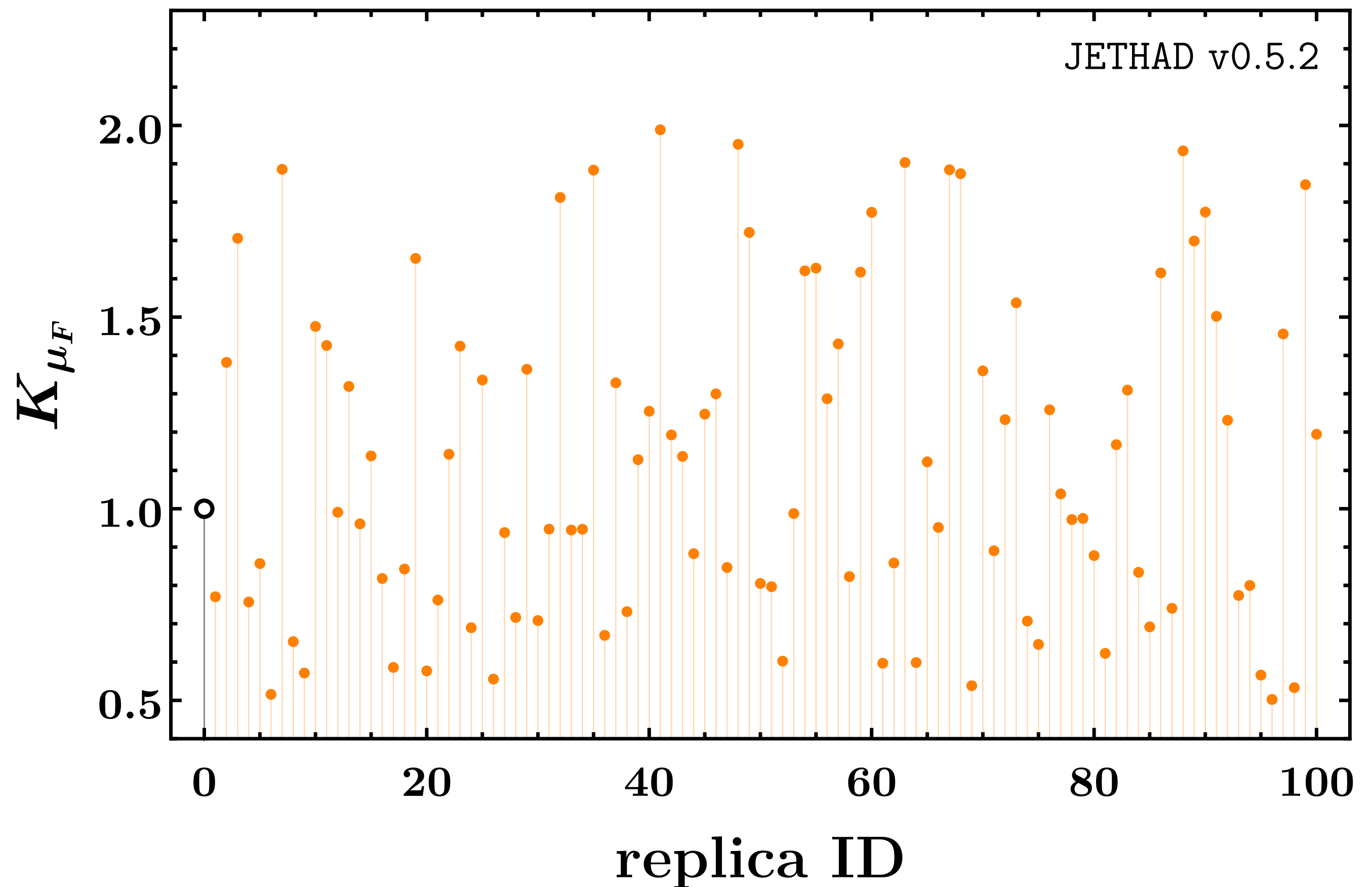
# Towards NREFF1.0: MHOU-replica analysis

Vector quarkonia

Evolution-ready renormalization scale



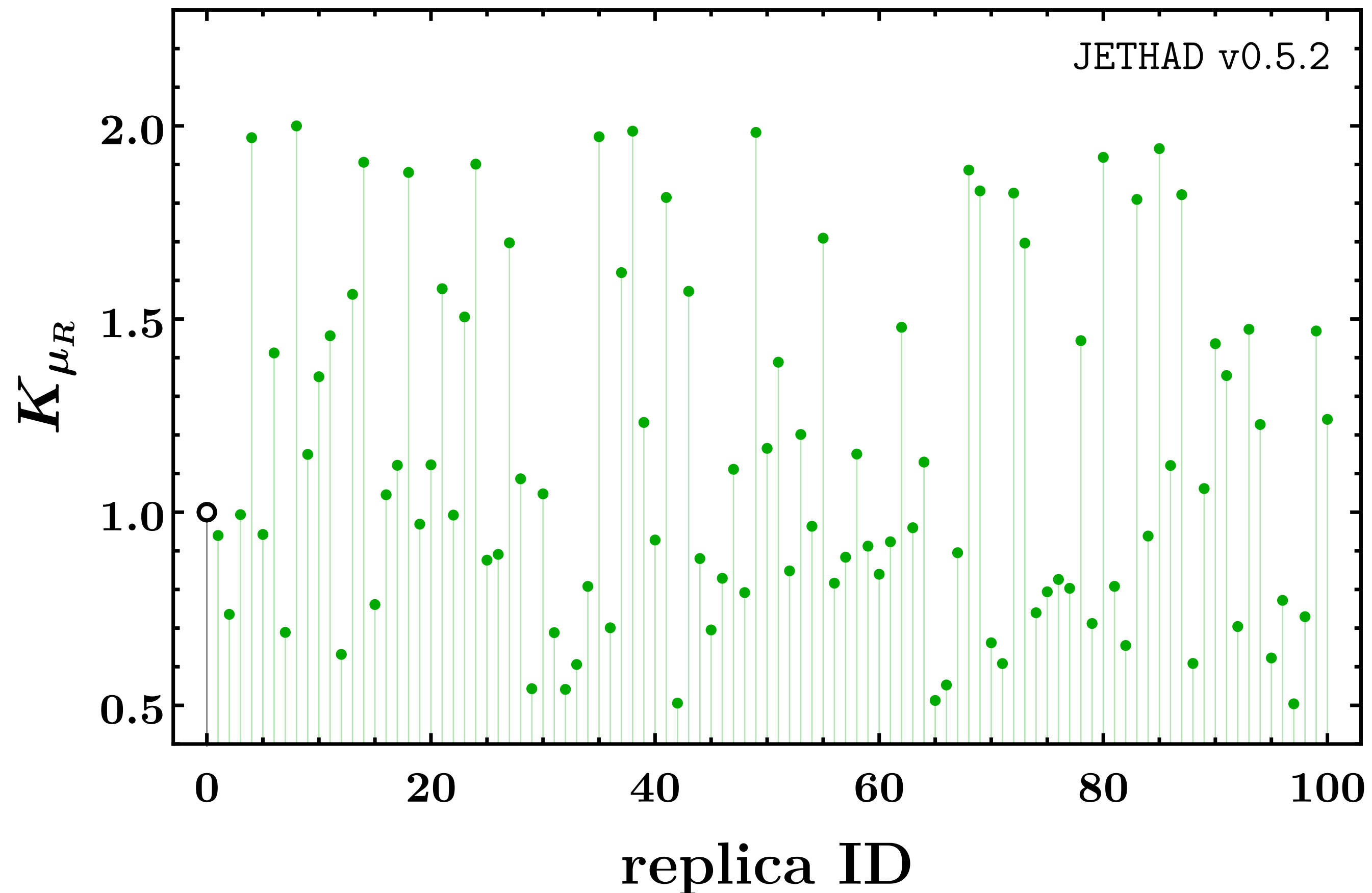
Evolution-ready factorization scale



# Towards NREF1.0: MHOU-replica analysis

Scalar quarkonia

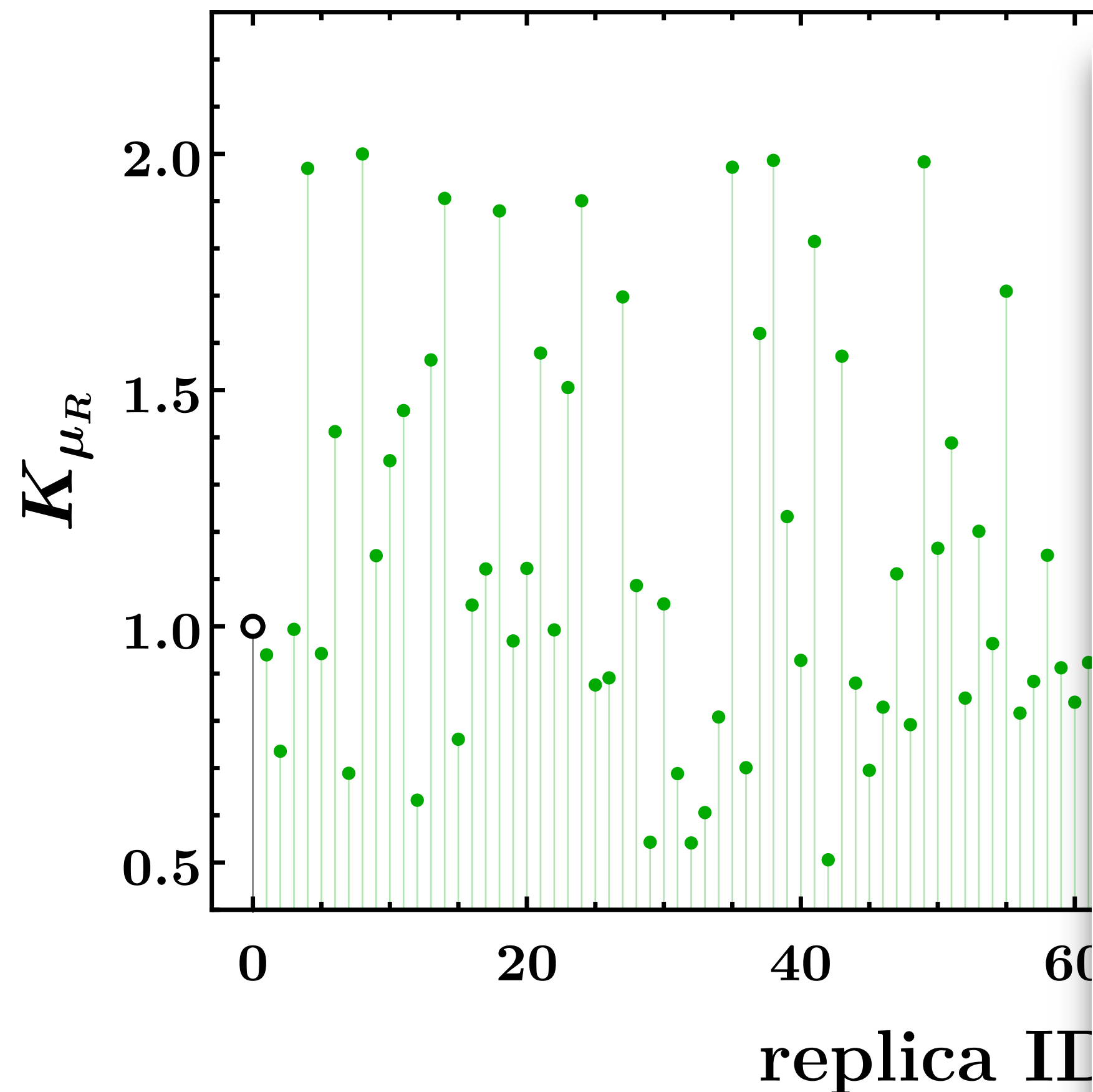
Evolution-ready renormalization scale



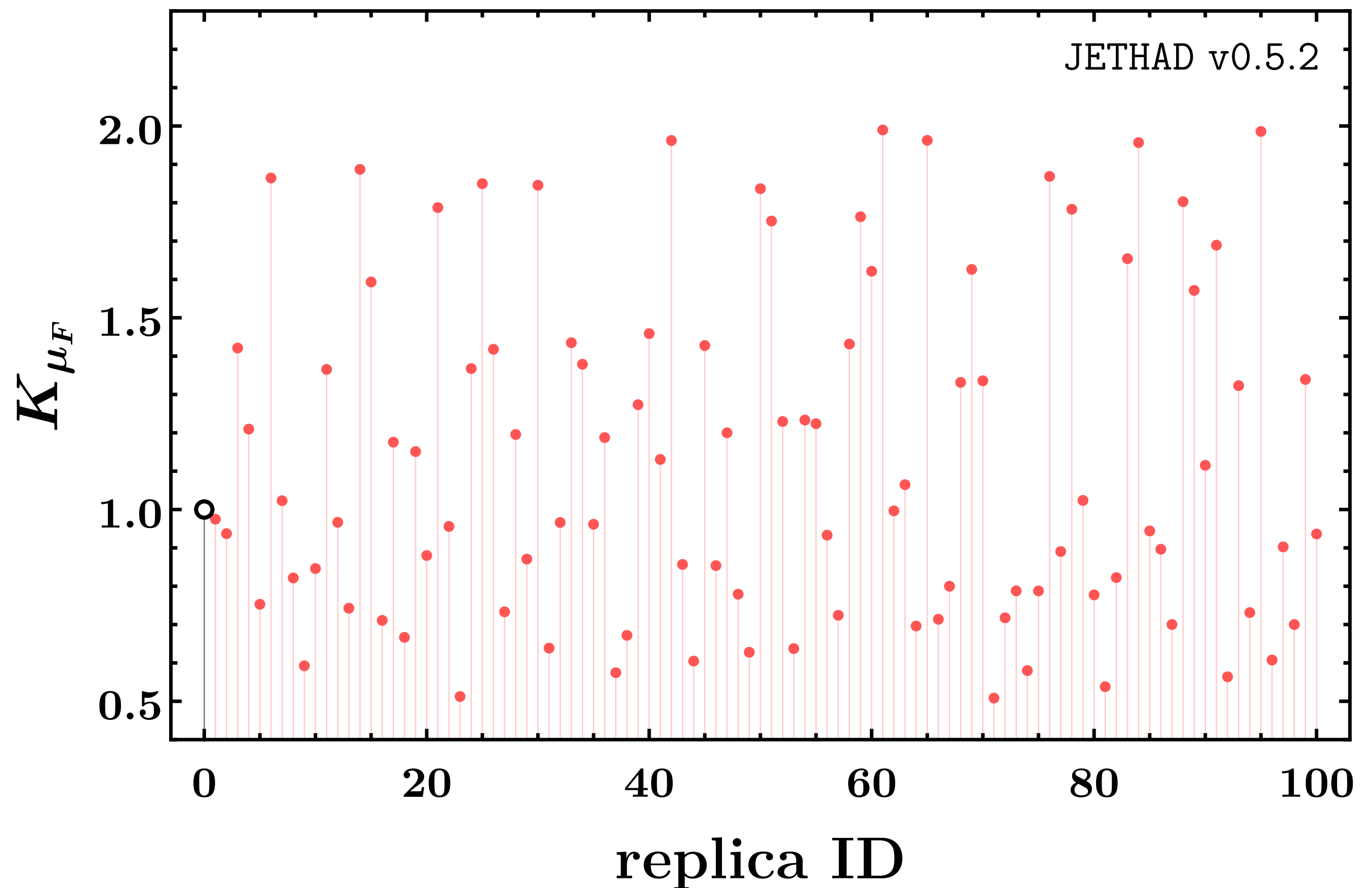
# Towards NREFF1.0: MHOU-replica analysis

Scalar quarkonia

Evolution-ready renormalization scale



Evolution-ready factorization scale



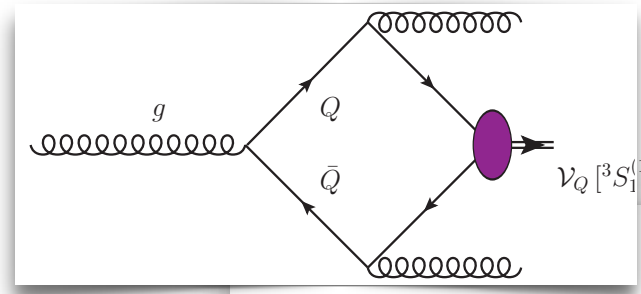
4

**NRF1.0\_cs\_n1o**

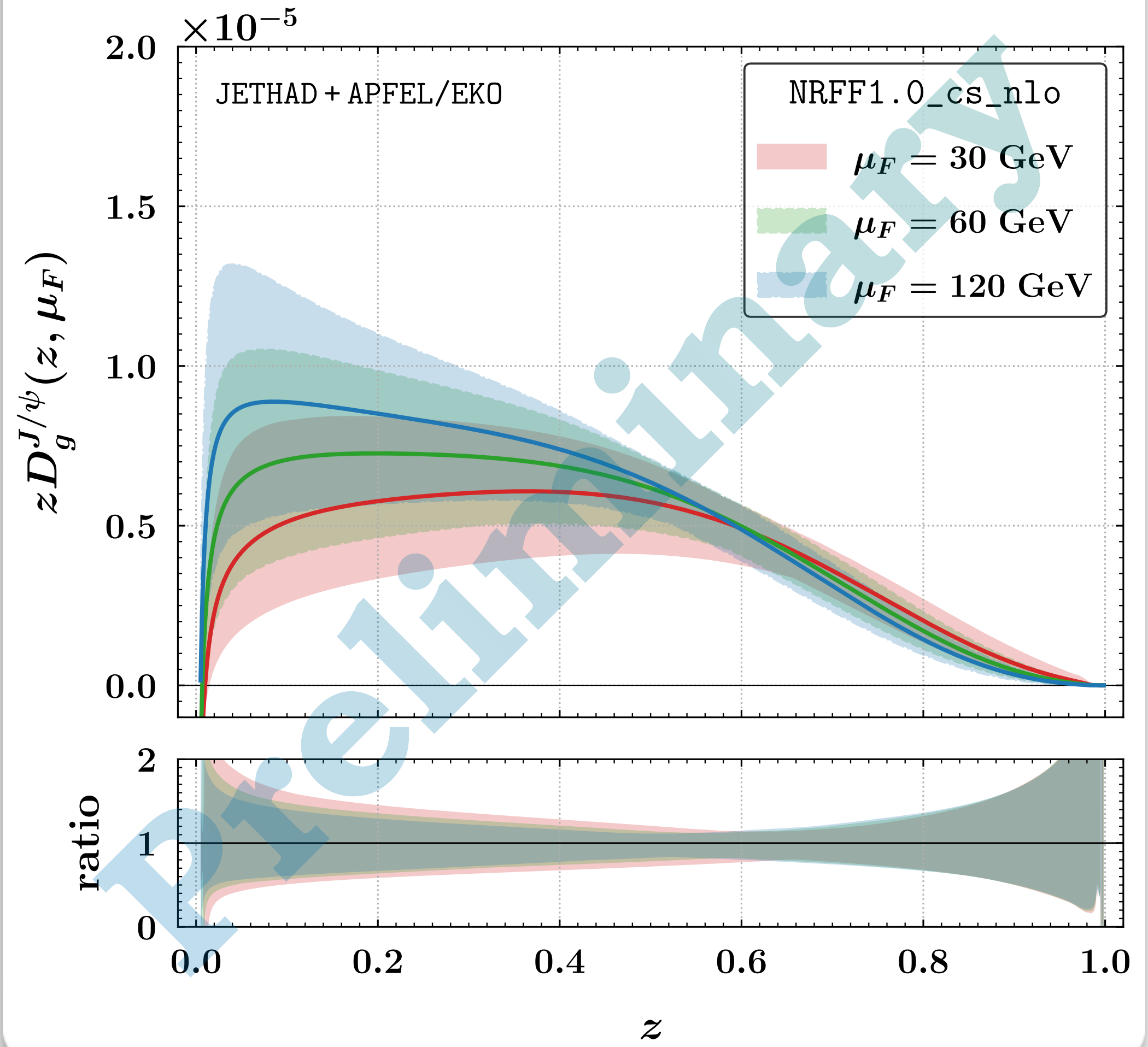


# NRFF1.0: Gluon fragmentation to charmonia

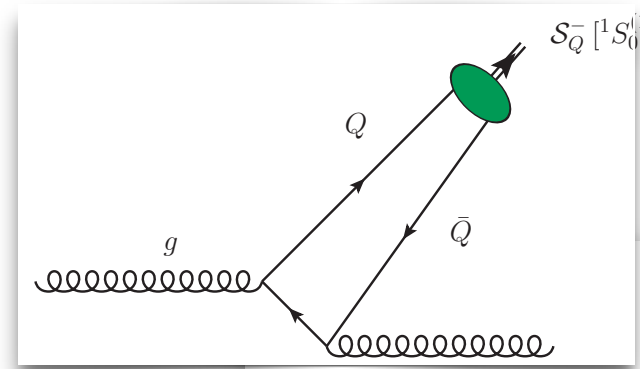
## Vector $J/\psi$



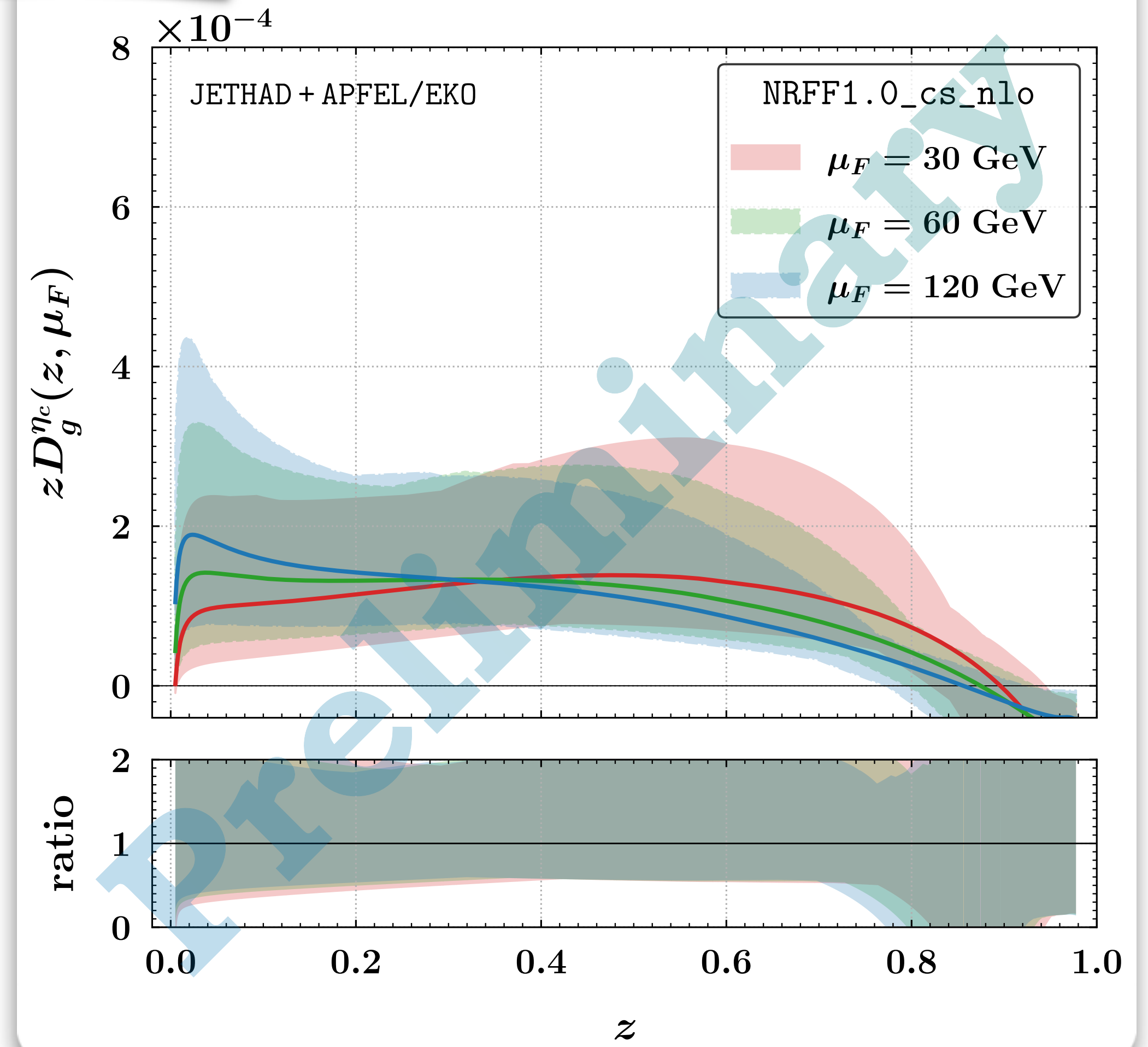
$(g \rightarrow J/\psi)$  fragmentation channel



## Scalar $\eta_c$

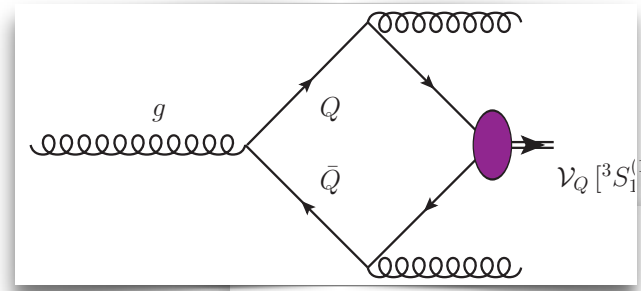


$(g \rightarrow \eta_c)$  fragmentation channel

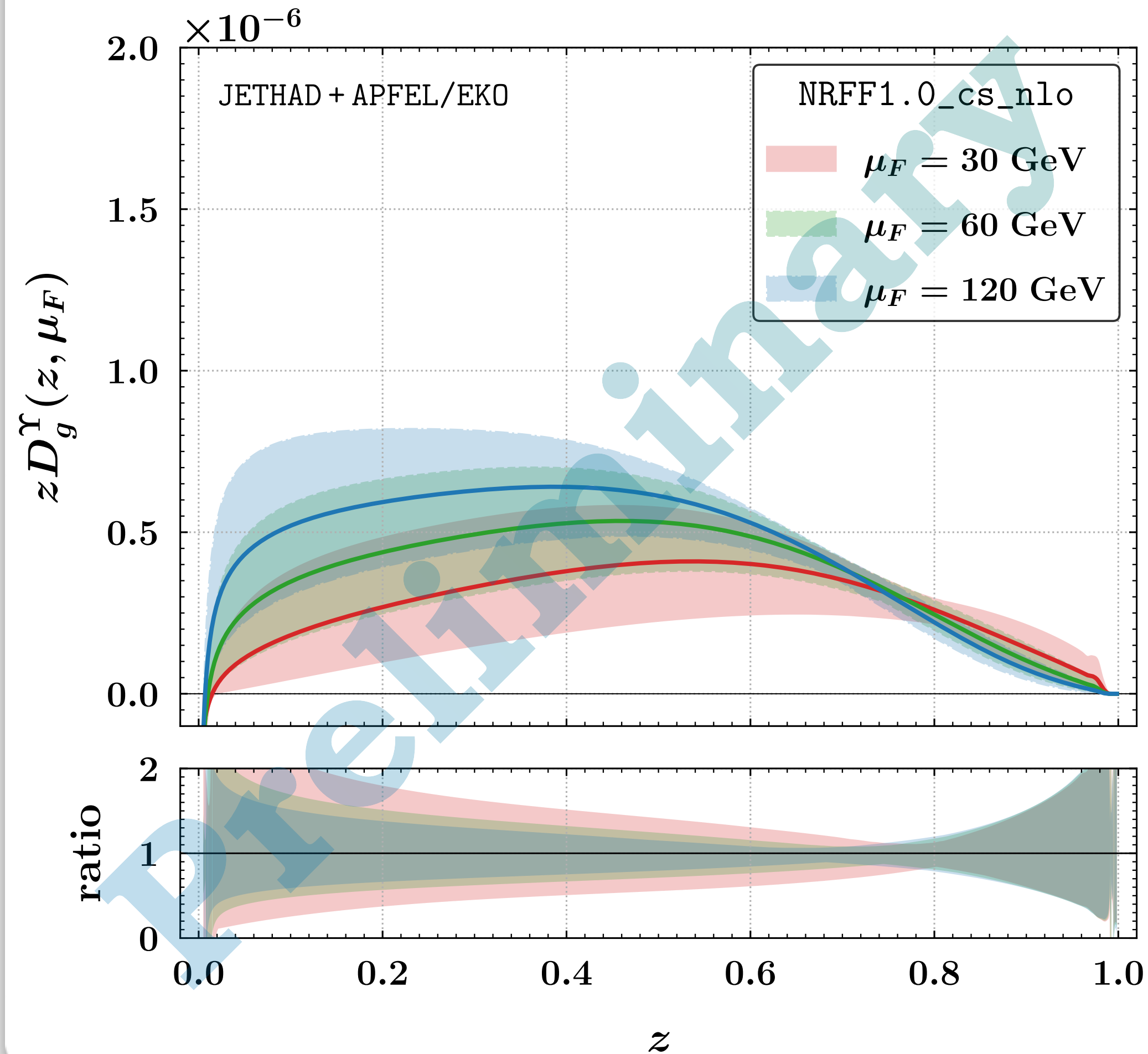


# NRFF1.0: Gluon fragmentation to bottomonia

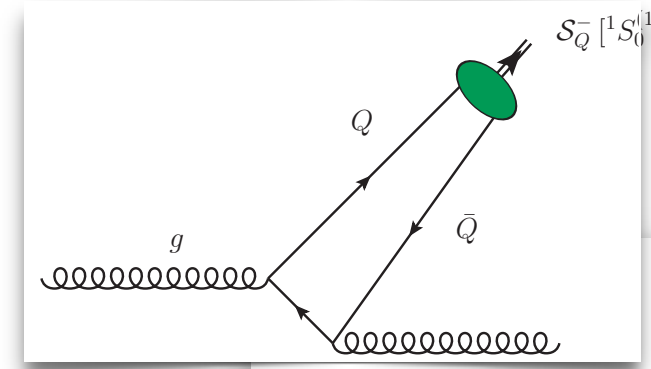
Vector  $\Upsilon$



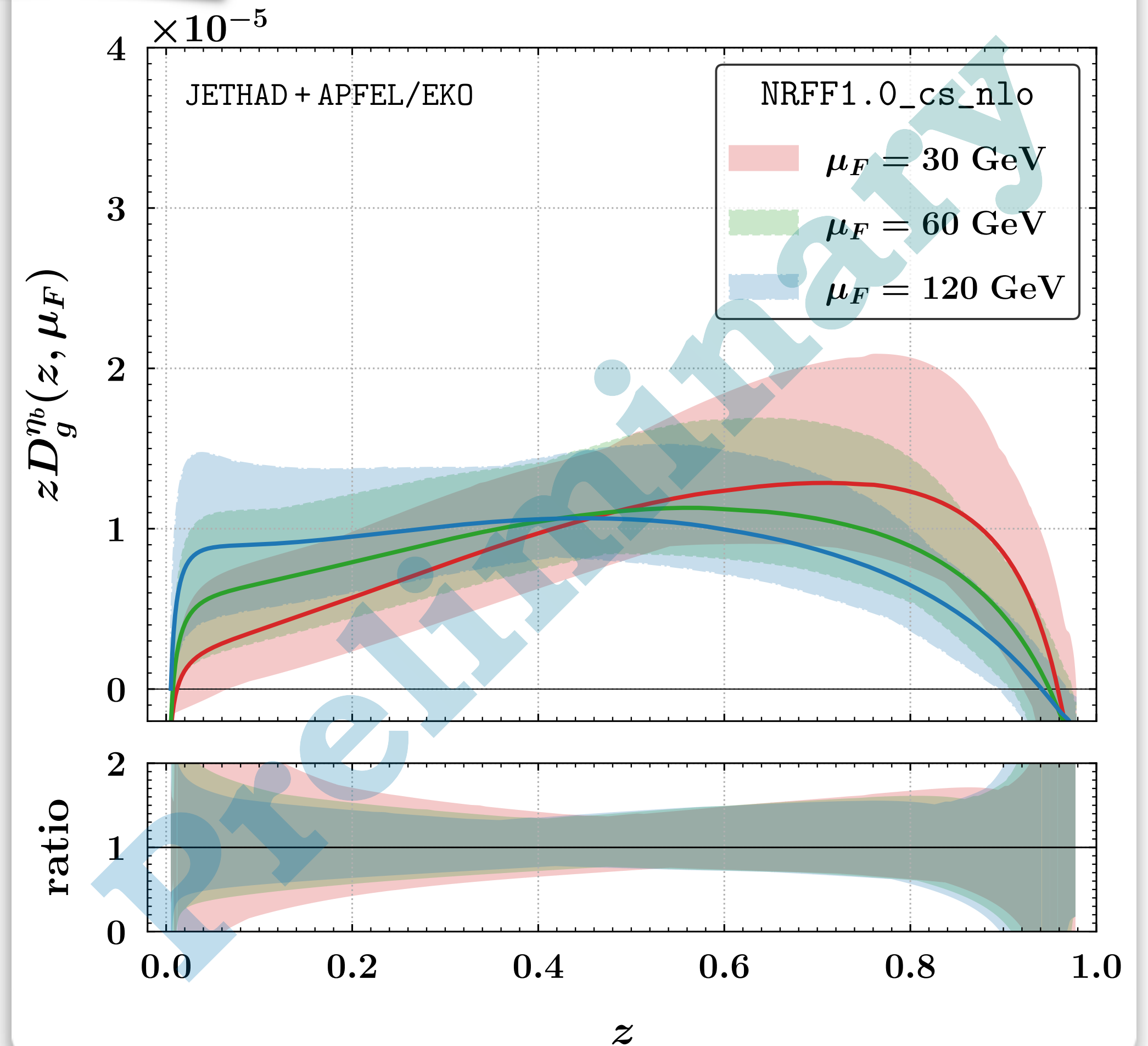
$(g \rightarrow \Upsilon)$  fragmentation channel



Scalar  $\eta_b$

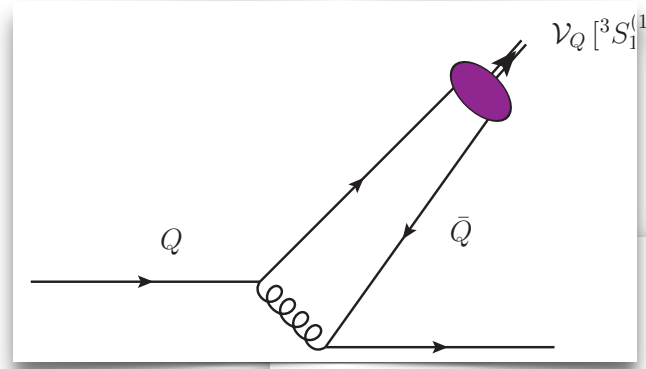


$(g \rightarrow \eta_b)$  fragmentation channel

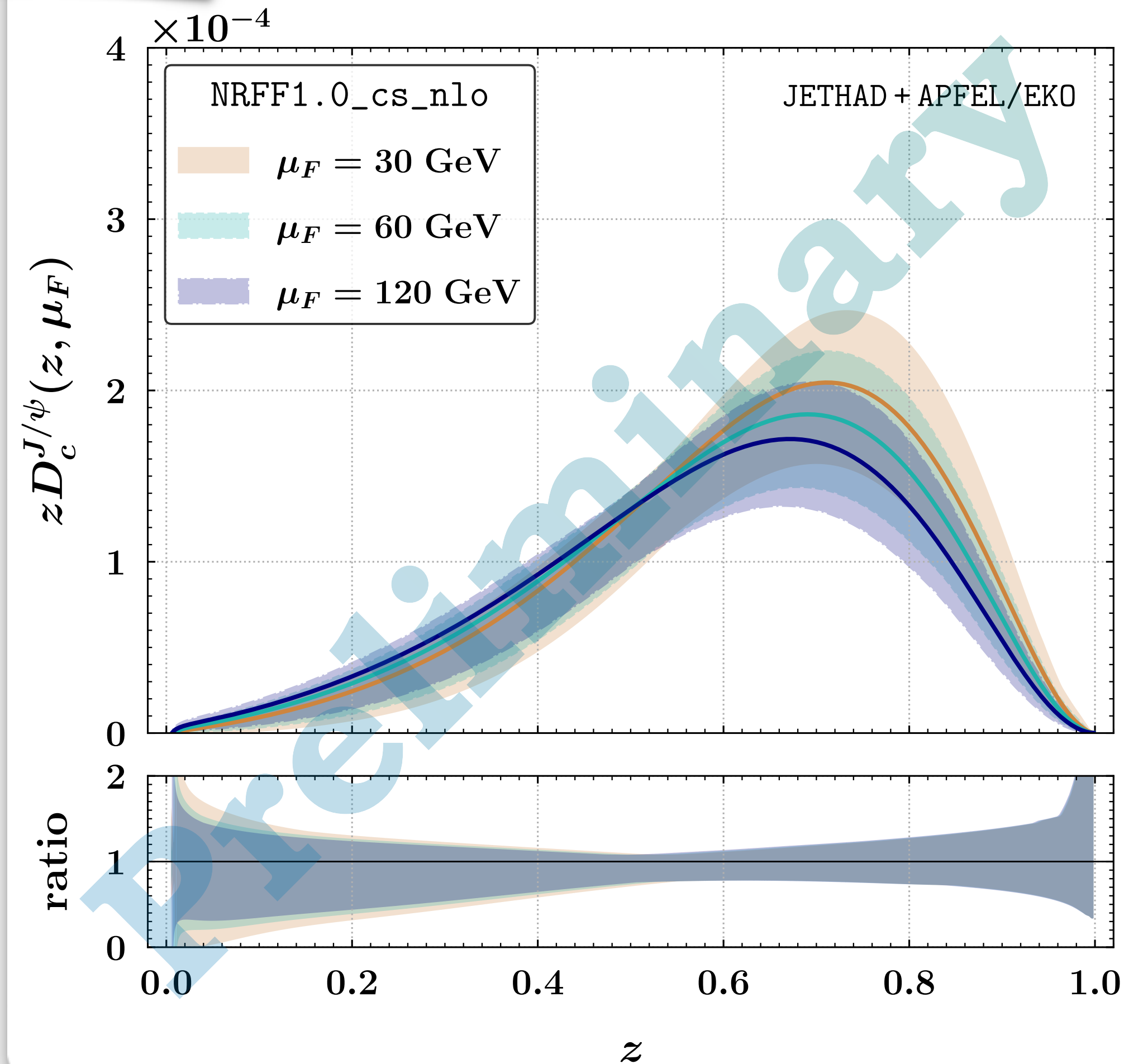


# NRFF1.0: Charm fragmentation to charmonia

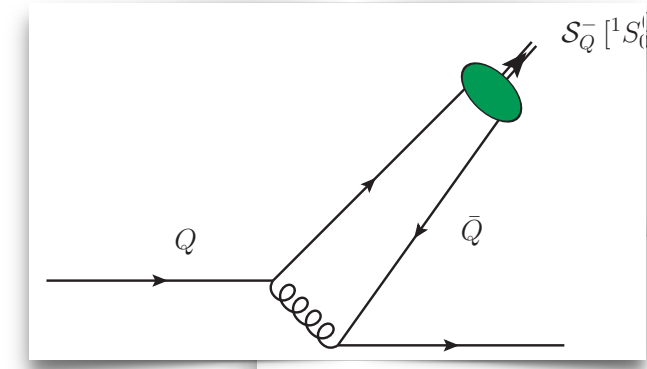
Vector  $J/\psi$



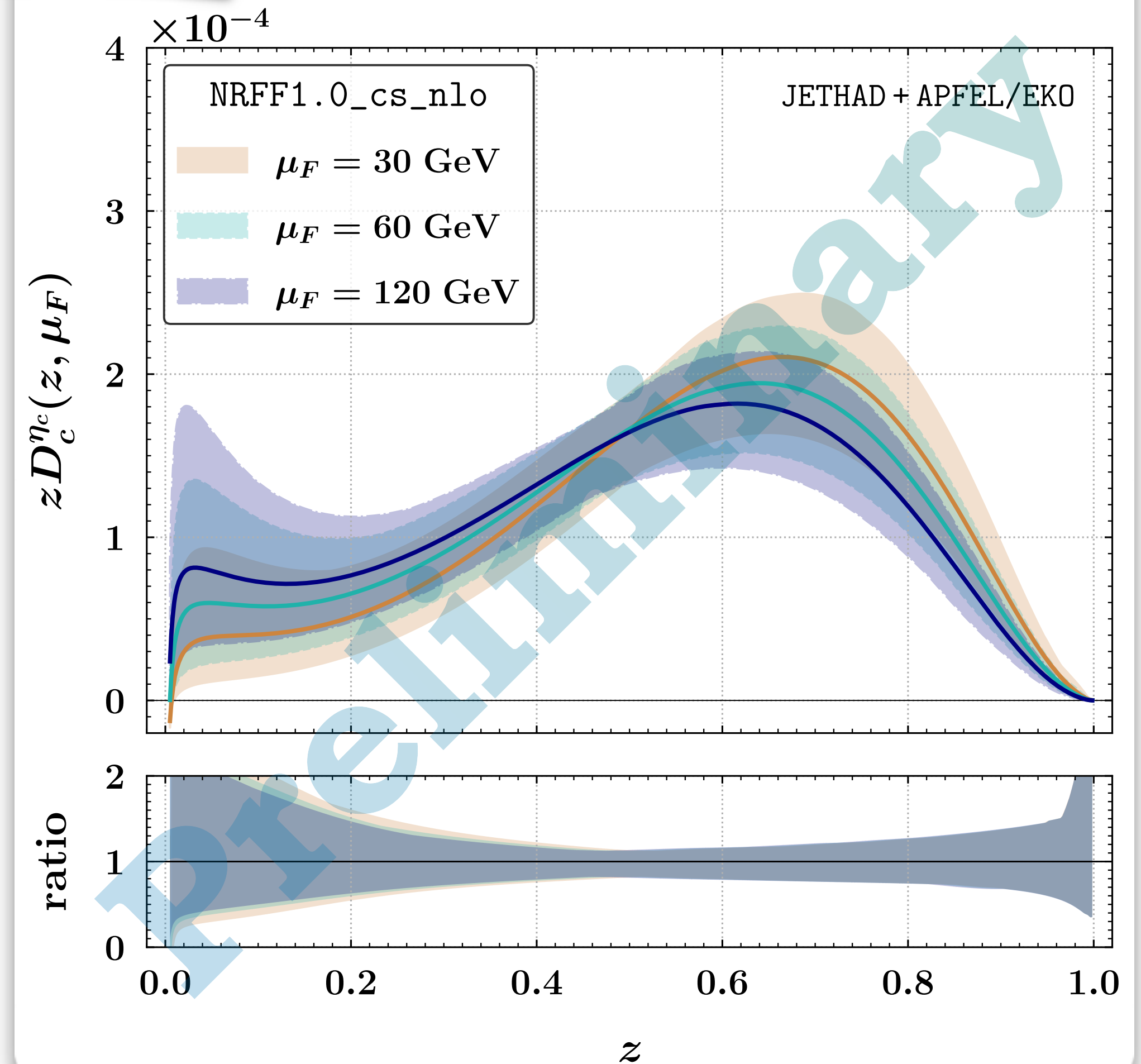
$(c \rightarrow J/\psi)$  fragmentation channel



Scalar  $\eta_c$

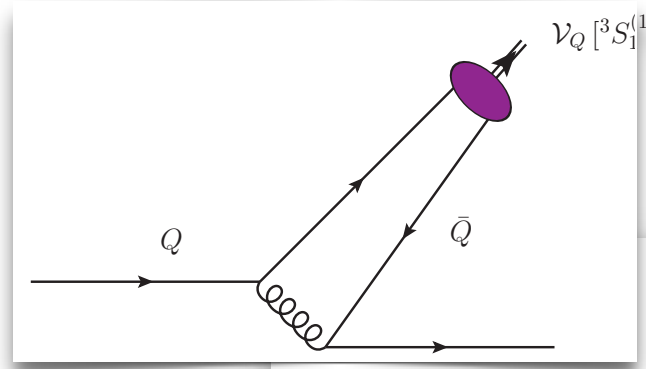


$(c \rightarrow \eta_c)$  fragmentation channel

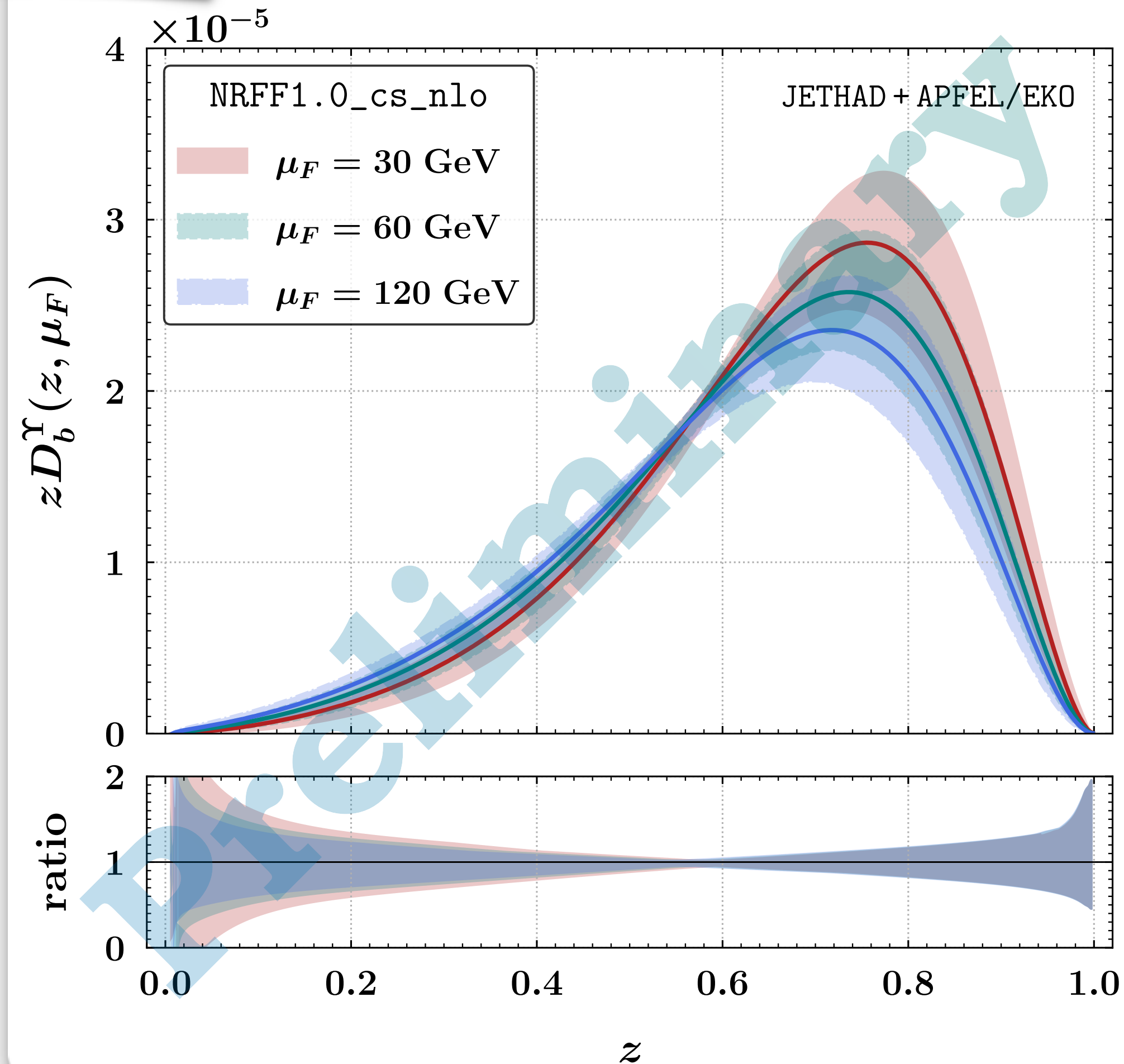


# NRFF1.0: Bottom fragmentation to bottomonia

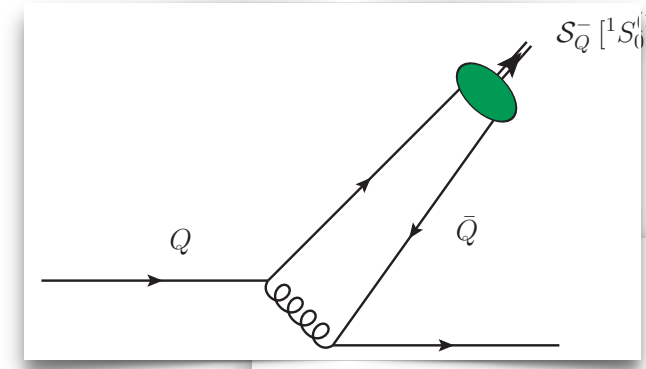
Vector  $\Upsilon$



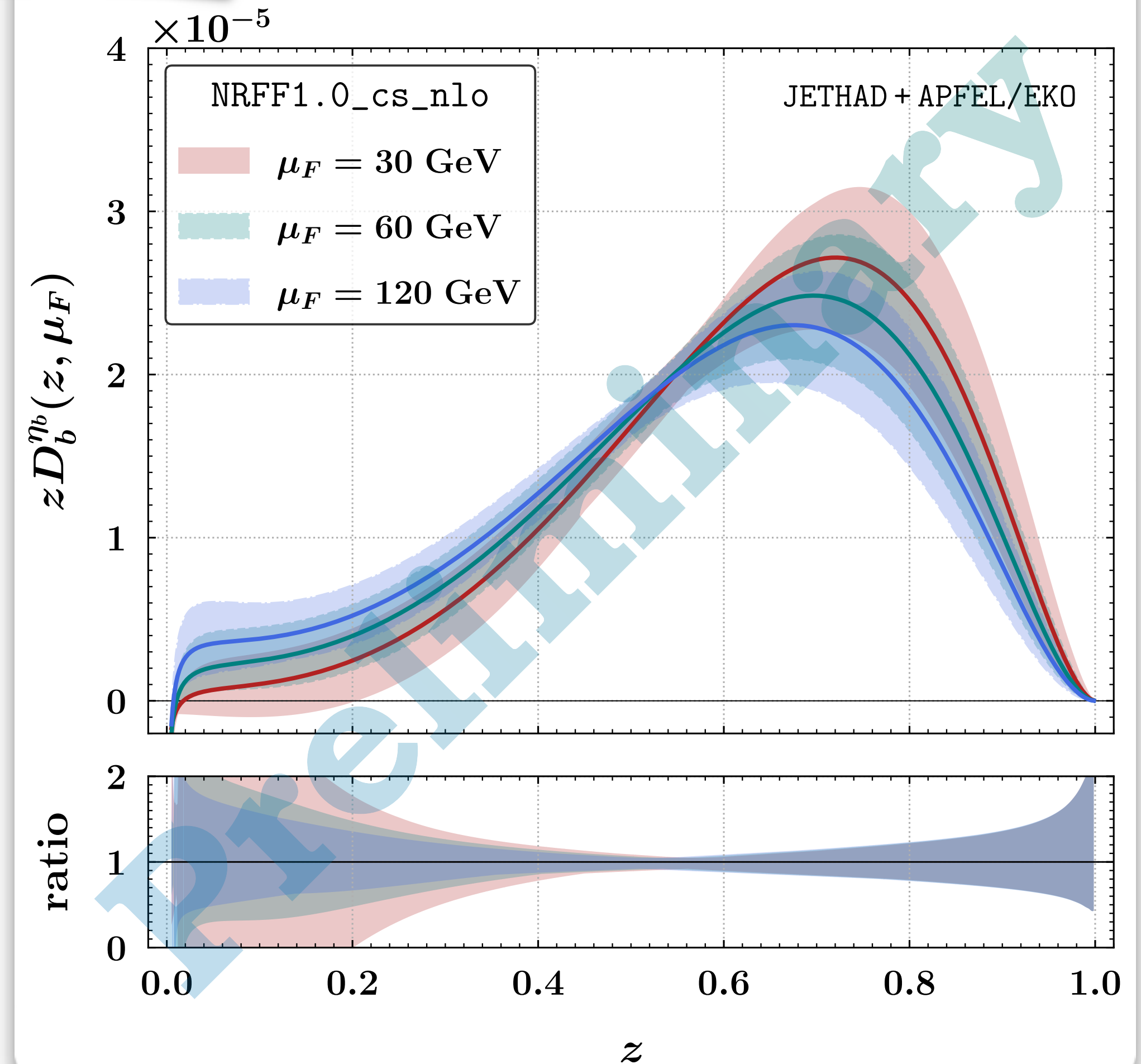
$(b \rightarrow \Upsilon)$  fragmentation channel



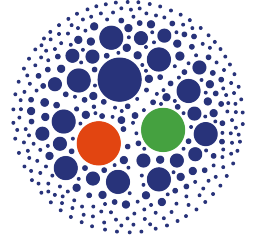
Scalar  $\eta_b$



$(b \rightarrow \eta_b)$  fragmentation channel



# Towards NREFF1.0 and beyond



Quarkonia as tools for precision studies of high-energy QCD

# Towards NRFF1.0 and beyond

 Quarkonia as tools for precision studies of high-energy QCD

 **NRFF1.0**  $\Rightarrow$  basis for explorations at HL-LHC, EIC,  $l^+l^-$  colliders

# Towards NRFF1.0 and beyond

 Quarkonia as tools for precision studies of high-energy QCD

 **NRFF1.0**  $\Rightarrow$  basis for explorations at HL-LHC, EIC,  $l^+l^-$  colliders

 Medium-term goals  $\Rightarrow$  Color Octet, GM-VFNS matching



# Towards NRFF1.0 and beyond

 Quarkonia as tools for precision studies of high-energy QCD

 **NRFF1.0**  $\Rightarrow$  basis for explorations at HL-LHC, EIC,  $l^+l^-$  colliders

 Medium-term goals  $\Rightarrow$  Color Octet, GM-VFNS matching

 AI-based extraction of onium FFs

# Towards NRFF1.0 and beyond

 Quarkonia as tools for precision studies of high-energy QCD

 **NRFF1.0**  $\Rightarrow$  basis for explorations at HL-LHC, EIC,  $l^+l^-$  colliders

 Medium-term goals  $\Rightarrow$  Color Octet, GM-VFNS matching

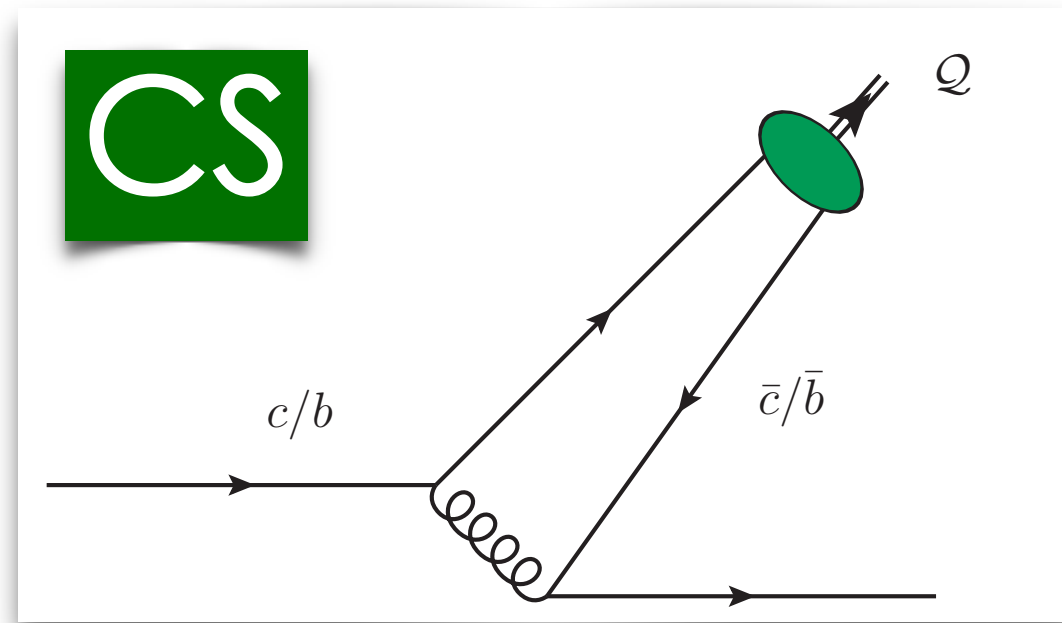
 AI-based extraction of onium FFs

***i Thanks for  
the attention !***

**EXTRAS**

# Vector quarkonium from single-parton fragmentation

! Let us consider  $J/\psi$  and  $\Upsilon$  at large  $p_T \rightarrow$  initial-scale **heavy-quark** + **gluon** from **NRQCD**!



$$D_Q^Q(z, \mu_F \equiv \mu_0) = D_Q^{Q,LO}(z) + \frac{\alpha_s^3(\mu_R)}{m_Q^3} |\mathcal{R}_Q(0)|^2 \Gamma^{Q,NLO}(z)$$

$(Q \rightarrow Q Q)$  at  $\mu_0 = 3m_Q$

(LO) [\[E. Braaten et al., Phys. Rev. D 48 \(1993\) 4230-4235\]](#)

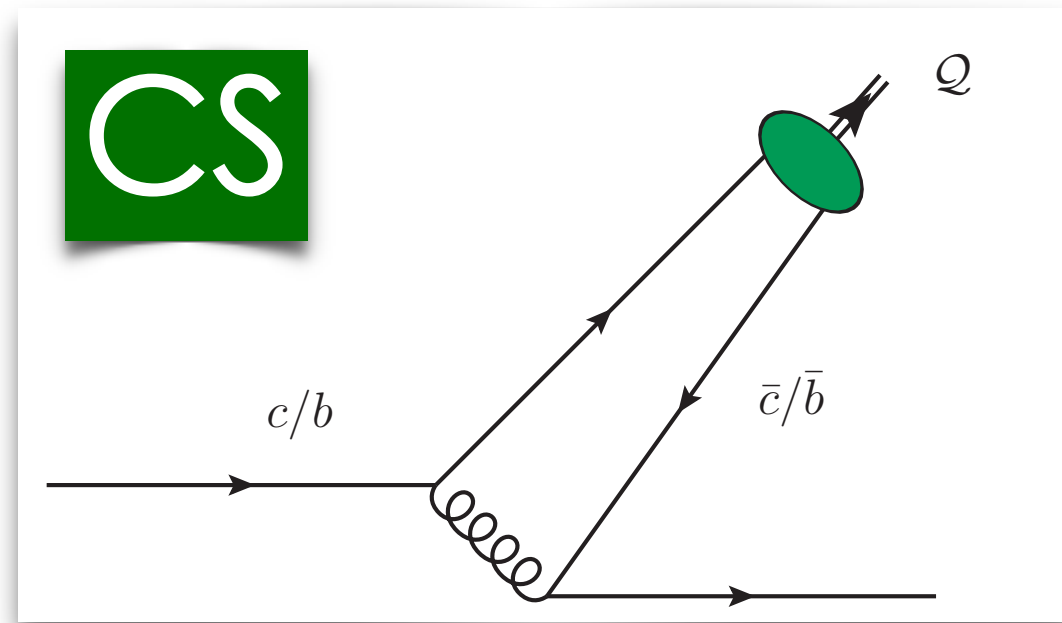
(NLO) [\[X. Zheng et al., Phys. Rev. D 100 \(2019\) 1, 014005\]](#)

[\[My talk at the Higgs Centre, Edinburgh \(2023\)\]](#)

[\[F. G. C., M. Fucilla, Eur. Phys. J. C 82 \(2022\) 10, 929\]](#)

# Vector quarkonium from single-parton fragmentation

! Let us consider  $J/\psi$  and  $\Upsilon$  at large  $p_T \rightarrow$  initial-scale **heavy-quark** + **gluon** from **NRQCD**!



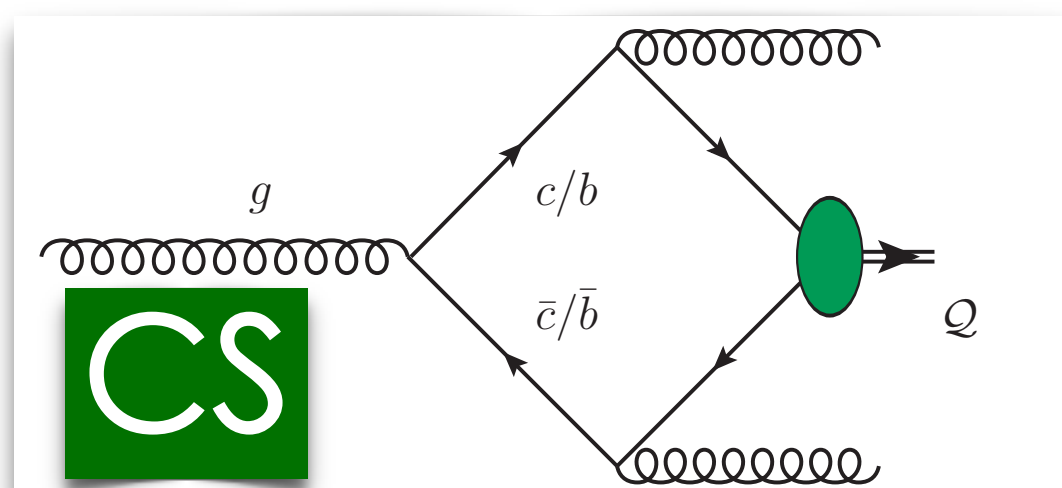
$$D_Q^Q(z, \mu_F \equiv \mu_0) = D_Q^{Q, \text{LO}}(z) + \frac{\alpha_s^3(\mu_R)}{m_Q^3} |\mathcal{R}_Q(0)|^2 \Gamma^{Q, \text{NLO}}(z)$$

$(Q \rightarrow Q Q)$  at  $\mu_0 = 3m_Q$

(LO) [\[E. Braaten et al., Phys. Rev. D 48 \(1993\) 4230-4235\]](#)

(NLO) [\[X. Zheng et al., Phys. Rev. D 100 \(2019\) 1, 014005\]](#)

+



$$D_g^Q(z, 2m_Q) = \frac{5}{36(2\pi)^2} \alpha_s^3(2m_Q) \frac{|\mathcal{R}_Q(0)|^2}{m_Q^3} \int_0^z d\xi \int_{(\xi+z^2)/2z}^{(1+\xi)/2} d\tau \frac{1}{(1-\tau)^2(\tau-\xi)^2(\tau^2-\xi)^2}$$

$(g \rightarrow Q gg)$  at  $\mu_0 = 2m_Q$

$$\sum_{i=1}^2 z^i \left[ f_i^{(g)}(\xi, \tau) + g_i^{(g)}(\xi, \tau) \frac{1+\xi-2\tau}{2(\tau-\xi)\sqrt{\tau^2-\xi}} \ln \left( \frac{\tau-\xi+\sqrt{\tau^2-\xi}}{\tau-\xi-\sqrt{\tau^2-\xi}} \right) \right],$$

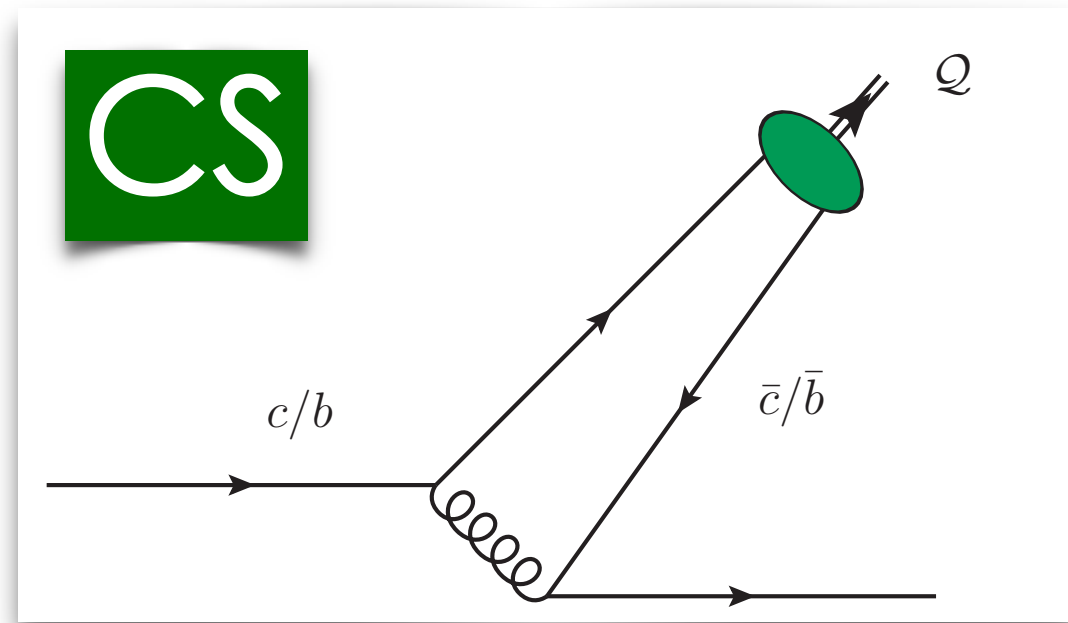
(LO) [\[A. Braaten, T.C Yuan, Phys. Rev. Lett. 71 \(1993\), 1673\]](#)

[\[My talk at the Higgs Centre, Edinburgh \(2023\)\]](#)

[\[F. G. C., M. Fucilla, Eur. Phys. J. C 82 \(2022\) 10, 929\]](#)

# Vector quarkonium from single-parton fragmentation

! Let us consider  $J/\psi$  and  $\Upsilon$  at large  $p_T \rightarrow$  initial-scale **heavy-quark** + **gluon** from **NRQCD**!



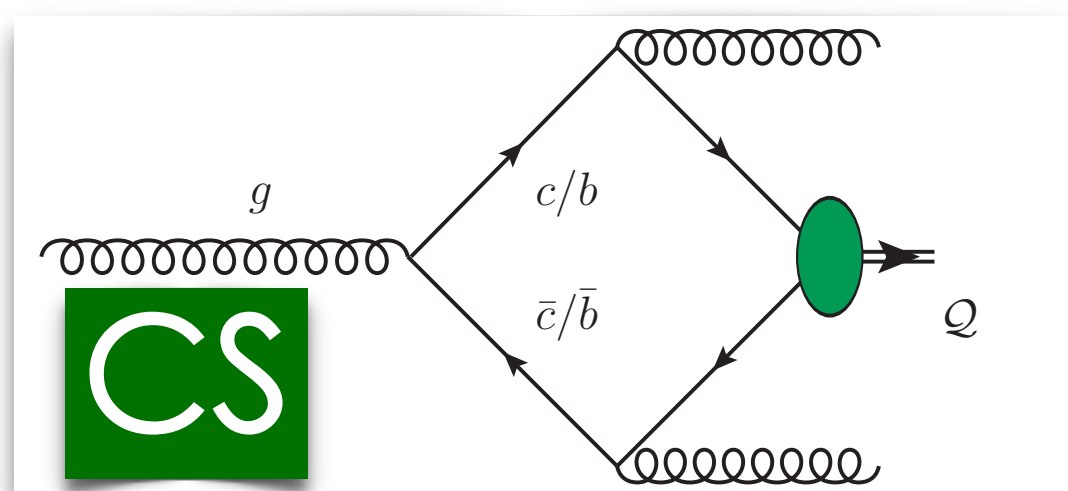
$$D_Q^Q(z, \mu_F \equiv \mu_0) = D_Q^{Q,LO}(z) + \frac{\alpha_s^3(\mu_R)}{m_Q^3} |\mathcal{R}_Q(0)|^2 \Gamma^{Q,NLO}(z)$$

$(Q \rightarrow Q Q)$  at  $\mu_0 = 3m_Q$

(LO) [\[E. Braaten et al., Phys. Rev. D 48 \(1993\) 4230-4235\]](#)

(NLO) [\[X. Zheng et al., Phys. Rev. D 100 \(2019\) 1, 014005\]](#)

+



$$D_g^Q(z, 2m_Q) = \frac{5}{36(2\pi)^2} \alpha_s^3(2m_Q) \frac{|\mathcal{R}_Q(0)|^2}{m_Q^3} \int_0^z d\xi \int_{(\xi+z^2)/2z}^{(1+\xi)/2} d\tau \frac{1}{(1-\tau)^2(\tau-\xi)^2(\tau^2-\xi)^2}$$

$(g \rightarrow Q gg)$  at  $\mu_0 = 2m_Q$

$$\sum_{i=1}^2 z^i \left[ f_i^{(g)}(\xi, \tau) + g_i^{(g)}(\xi, \tau) \frac{1+\xi-2\tau}{2(\tau-\xi)\sqrt{\tau^2-\xi}} \ln \left( \frac{\tau-\xi+\sqrt{\tau^2-\xi}}{\tau-\xi-\sqrt{\tau^2-\xi}} \right) \right],$$

(LO) [\[A. Braaten, T.C Yuan, Phys. Rev. Lett. 71 \(1993\), 1673\]](#)

⊗

[\[My talk at the Higgs Centre, Edinburgh \(2023\)\]](#)

[\[F. G. C., M. Fucilla, Eur. Phys. J. C 82 \(2022\) 10, 929\]](#)

**NRFF1.0**

quarkonium FFs

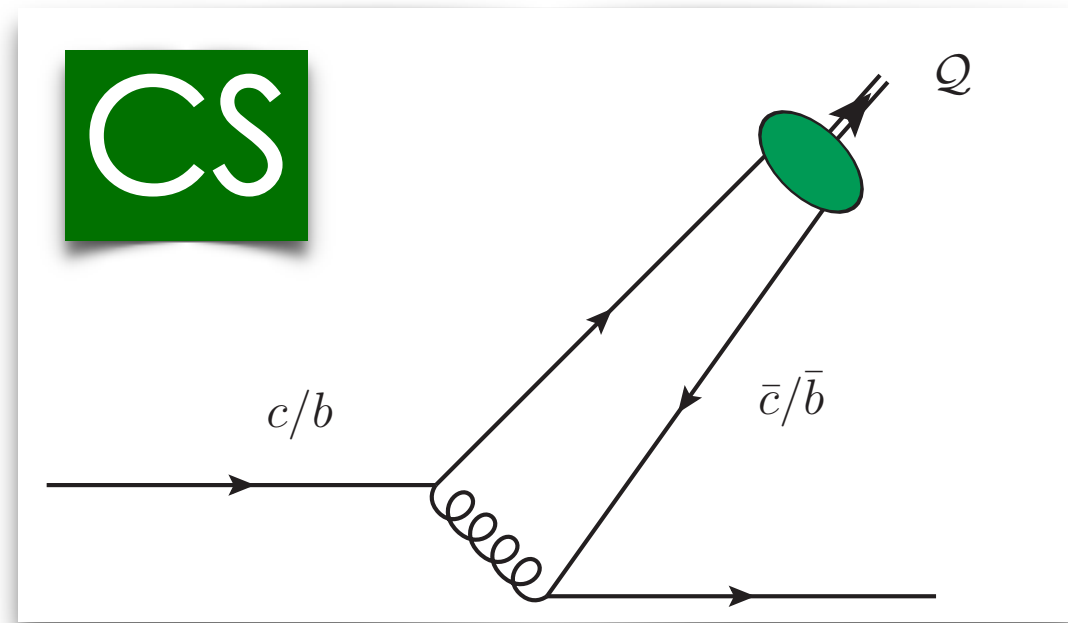
=

**APFEL++/EKO**

Backup

# Vector quarkonium from single-parton fragmentation

! Let us consider  $J/\psi$  and  $\Upsilon$  at large  $p_T \rightarrow$  initial-scale **heavy-quark** + **gluon** from **NRQCD**!

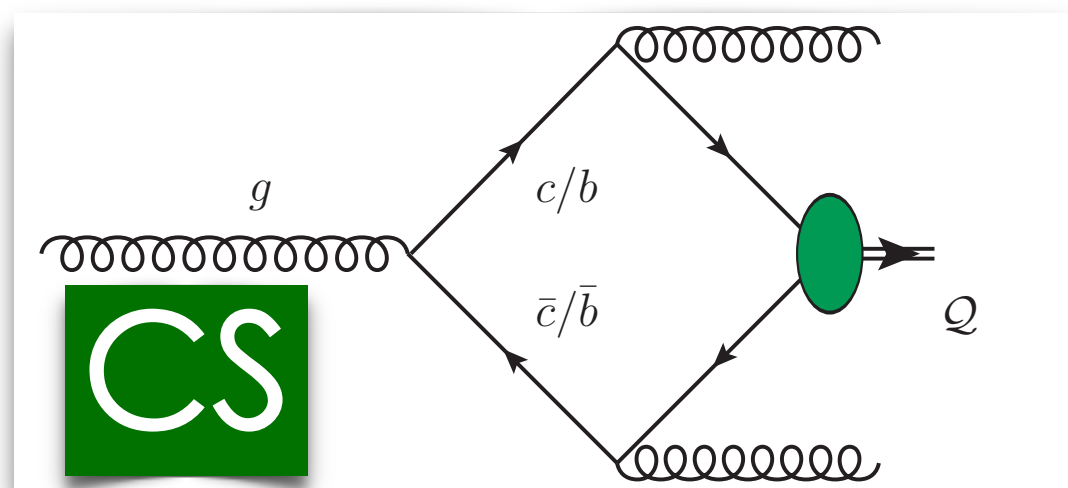


$$D_Q^Q(z, \mu_F \equiv \mu_0) = D_Q^{Q,LO}(z) + \frac{\alpha_s^3(\mu_R)}{m_Q^3} |\mathcal{R}_Q(0)|^2$$

(LO) [\[E. Braaten et al., Phys. Rev. D 48 \(1993\) 4230-4234\]](#)  
 (NLO) [\[X. Zheng et al., Phys. Rev. D 100 \(2019\) 1, 014005\]](#)

$(Q \rightarrow Q Q)$  at  $\mu_0 = 3m_Q$

+



$$D_g^Q(z, 2m_Q) = \frac{5}{36(2\pi)^2} \alpha_s^3(2m_Q) \frac{|\mathcal{R}_Q(0)|^2}{m_Q^3} \int_0^z d\xi \int_{(\xi+z^2)/2z}^{(1+\xi)/2} d\tau \frac{1}{(1-\tau)^2} \sum_{i=1}^2 z^i \left[ f_i^{(g)}(\xi, \tau) + g_i^{(g)}(\xi, \tau) \frac{1+\xi-2\tau}{2(\tau-\xi)\sqrt{\tau^2-\xi}} \ln \left( \frac{\tau-\xi+\sqrt{\tau^2-\xi}}{\tau-\xi-\sqrt{\tau^2-\xi}} \right) \right]$$

(LO) [\[A. Braaten, T.C Yuan, Phys. Rev. Lett. 71 \(1993\), 1673\]](#)

$(g \rightarrow Q gg)$  at  $\mu_0 = 2m_Q$

⊗

[\[My talk at the Higgs Centre, Edinburgh \(2023\)\]](#)  
[\[F. G. C., M. Fucilla, Eur. Phys. J. C 82 \(2022\) 10, 929\]](#)

**NRFF1.0**

quarkonium FFs

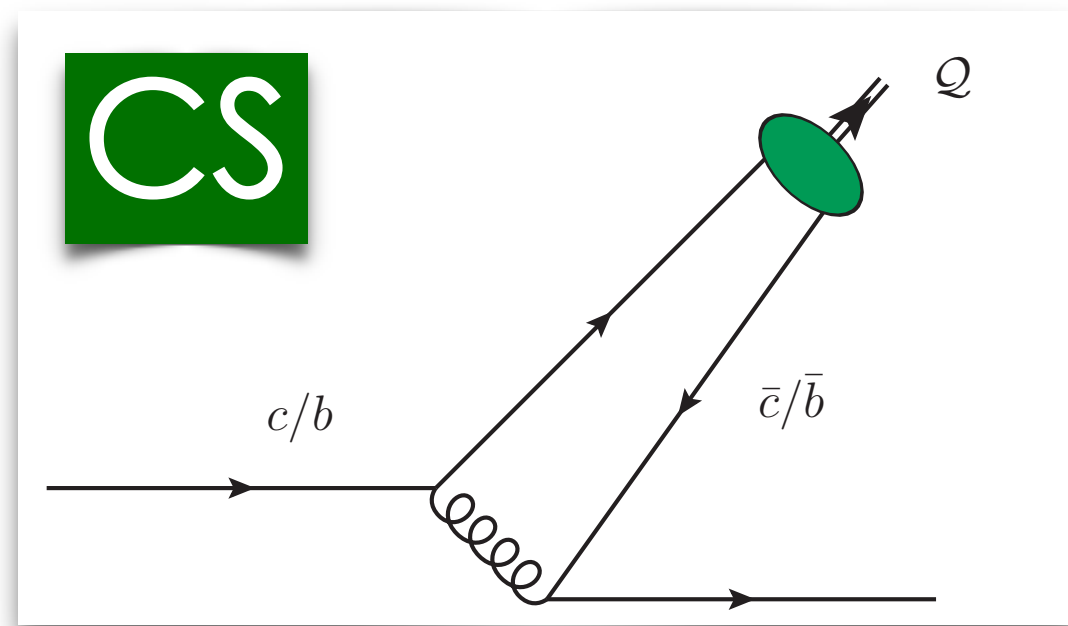
=

**APFEL++/EKO**

Backup

# Vector quarkonium from single-parton fragmentation

! Let us consider  $J/\psi$  and  $\Upsilon$  at large  $p_T \rightarrow$  initial-scale **heavy-quark** + **gluon** from **NRQCD**!



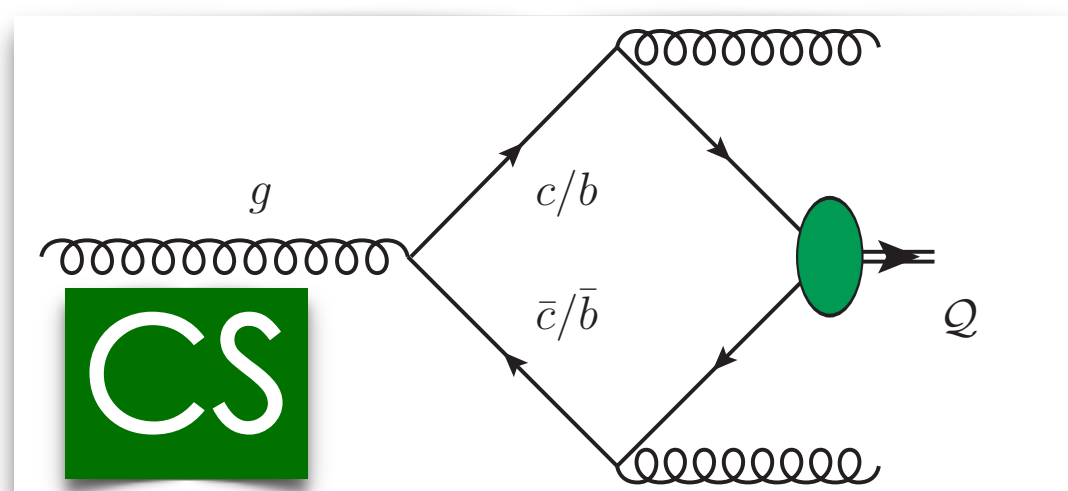
$$D_Q^Q(z, \mu_F \equiv \mu_0) = D_Q^{Q,LO}(z) + \frac{\alpha_s^3(\mu_R)}{m_Q^3} |\mathcal{R}_Q(0)|^2$$

(LO) [\[E. Braaten et al., Phys. Rev. D 48 \(1993\) 4230-4234\]](#)  
 (NLO) [\[X. Zheng et al., Phys. Rev. D 100 \(2019\) 1, 014005\]](#)



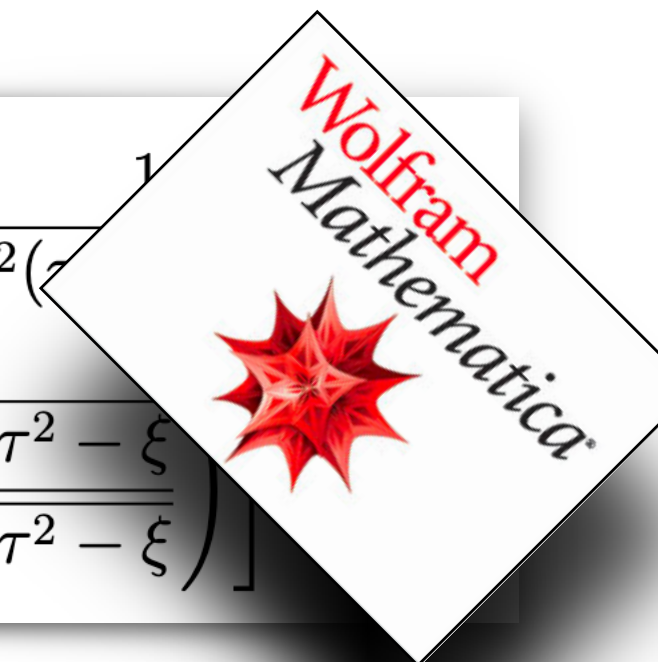
$(Q \rightarrow Q Q)$  at  $\mu_0 = 3m_Q$

+



$$D_g^Q(z, 2m_Q) = \frac{5}{36(2\pi)^2} \alpha_s^3(2m_Q) \frac{|\mathcal{R}_Q(0)|^2}{m_Q^3} \int_0^z d\xi \int_{(\xi+z^2)/2z}^{(1+\xi)/2} d\tau \frac{1}{(1-\tau)^2} \sum_{i=1}^2 z^i \left[ f_i^{(g)}(\xi, \tau) + g_i^{(g)}(\xi, \tau) \frac{1+\xi-2\tau}{2(\tau-\xi)\sqrt{\tau^2-\xi}} \ln \left( \frac{\tau-\xi+\sqrt{\tau^2-\xi}}{\tau-\xi-\sqrt{\tau^2-\xi}} \right) \right]$$

(LO) [\[A. Braaten, T.C Yuan, Phys. Rev. Lett. 71 \(1993\), 1673\]](#)



$(g \rightarrow Q gg)$  at  $\mu_0 = 2m_Q$



[\[My talk at the Higgs Centre, Edinburgh \(2023\)\]](#)  
[\[F. G. C., M. Fucilla, Eur. Phys. J. C 82 \(2022\) 10, 929\]](#)

**NRFF1.0**

quarkonium FFs

=

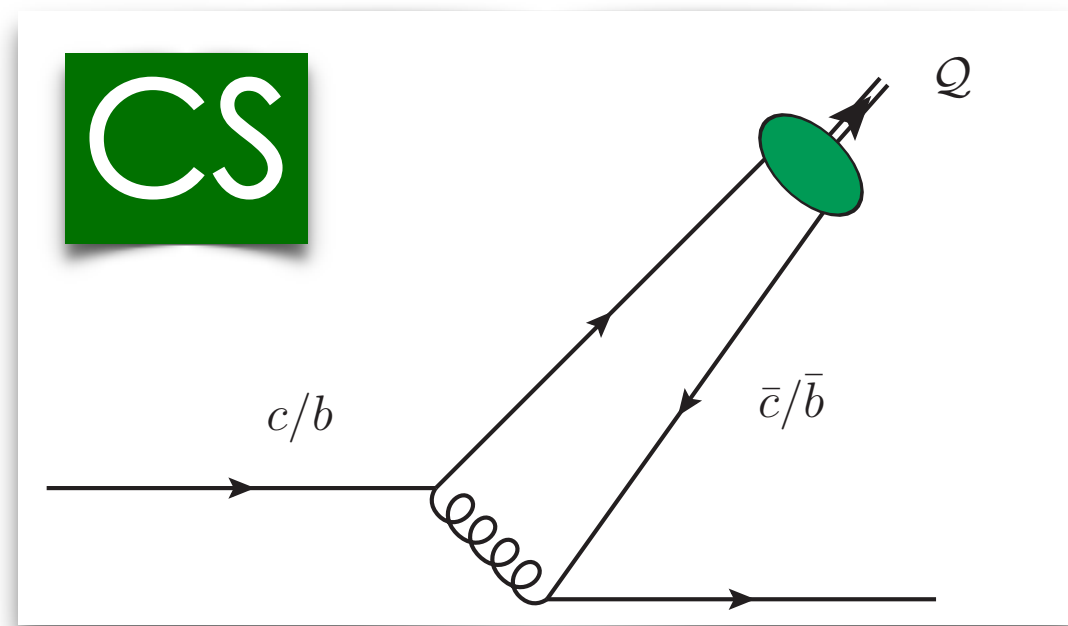
**APFEL++/EKO**

**Backup**



# Vector quarkonium from single-parton fragmentation

! Let us consider  $J/\psi$  and  $\Upsilon$  at large  $p_T \rightarrow$  initial-scale **heavy-quark** + **gluon** from **NRQCD**!



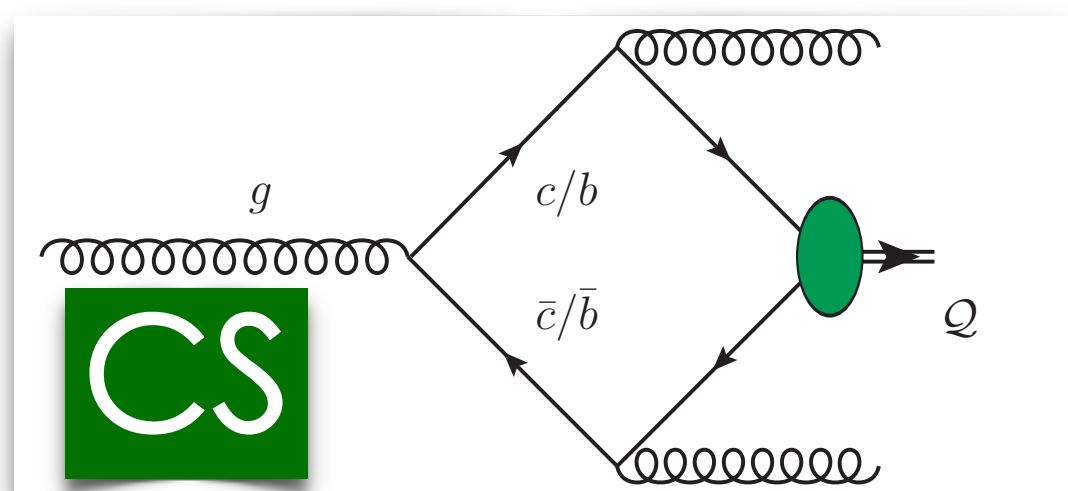
$$D_Q^Q(z, \mu_F \equiv \mu_0) = D_Q^{Q,LO}(z) + \frac{\alpha_s^3(\mu_R)}{m_Q^3} |\mathcal{R}_Q(0)|^2$$

(LO) [\[E. Braaten et al., Phys. Rev. D 48 \(1993\) 4230-4234\]](#)  
 (NLO) [\[X. Zheng et al., Phys. Rev. D 100 \(2019\) 1, 014005\]](#)



$(Q \rightarrow Q Q)$  at  $\mu_0 = 3m_Q$

+



$$D_g^Q(z, 2m_Q) = \frac{5}{36(2\pi)^2} \alpha_s^3(2m_Q) \frac{|\mathcal{R}_Q(0)|^2}{m_Q^3} \int_0^z d\xi \int_{(\xi+z^2)/2z}^{(1+\xi)/2} d\tau \frac{1}{(1-\tau)^2} \sum_{i=1}^2 z^i \left[ f_i^{(g)}(\xi, \tau) + g_i^{(g)}(\xi, \tau) \frac{1+\xi-2\tau}{2(\tau-\xi)\sqrt{\tau^2-\xi}} \ln \left( \frac{\tau-\xi+\sqrt{\tau^2-\xi}}{\tau-\xi-\sqrt{\tau^2-\xi}} \right) \right]$$

(LO) [\[A. Braaten, T.C Yuan, Phys. Rev. Lett. 71 \(1993\), 1673\]](#)



$(g \rightarrow Q gg)$  at  $\mu_0 = 2m_Q$



[\[My talk at the Higgs Centre, Edinburgh \(2023\)\]](#)  
[\[F. G. C., M. Fucilla, Eur. Phys. J. C 82 \(2022\) 10, 929\]](#)



**NRFF1.0**

quarkonium FFs

=

**APFEL++/EKO**

Backup

# Towards NREFF1.0: ¿ A connection with MCscales ?



PUBLISHED FOR SISSA BY SPRINGER

RECEIVED: September 13, 2022

REVISED: January 12, 2023

ACCEPTED: March 7, 2023

PUBLISHED: March 20, 2023

## Parton distributions with scale uncertainties: a Monte Carlo sampling approach

Zahari Kassabov,<sup>a</sup> Maria Ubiali<sup>a</sup> and Cameron Voisey<sup>b</sup>

<sup>a</sup>DAMTP, University of Cambridge,  
Wilberforce Road, Cambridge, CB3 0WA, U.K.

<sup>b</sup>Cavendish Laboratory (HEP),  
JJ Thomson Avenue, Cambridge, CB3 0HE, U.K.

E-mail: [zk261@cam.ac.uk](mailto:zk261@cam.ac.uk), [mu227@cam.ac.uk](mailto:mu227@cam.ac.uk), [voisey@hep.phy.cam.ac.uk](mailto:voisey@hep.phy.cam.ac.uk)

ABSTRACT: We present the MCscales approach for incorporating scale uncertainties in parton distribution functions (PDFs). The new methodology builds on the Monte Carlo sampling for propagating experimental uncertainties into the PDF space that underlies the NNPDF approach, but it extends it to the space of factorisation and renormalisation scales. A *prior* probability is assigned to each scale combinations set in the theoretical predictions used to obtain each PDF replica in the Monte Carlo ensemble and a *posterior* probability is obtained by selecting replicas that satisfy fit-quality criteria. Our approach allows one to exactly match the scale variations in the PDFs with those in the computation of the partonic cross sections, thus accounting for the full correlations between the two. We illustrate the opportunities for phenomenological exploration made possible by our methodology for a variety of LHC observables. Sets of PDFs enriched with scale information are provided, along with a set of tools to use them.

KEYWORDS: Parton Distributions, Specific QCD Phenomenology

ARXIV EPRINT: [2207.07616](https://arxiv.org/abs/2207.07616)

JHEP03(2023)148

# Towards NREFF1.0: A connection with MCscales?



PUBLISHED FOR SISSA BY SPRINGER

RECEIVED: September 13, 2022

REVISED: January 12, 2023

ACCEPTED: March 7, 2023

PUBLISHED: March 20, 2023

## Parton distributions with scale uncertainties: a Monte Carlo sampling approach

Zahari Kassabov,<sup>a</sup> Maria Ubiali<sup>a</sup> and Cameron Voisey<sup>b</sup>

<sup>a</sup>DAMTP, University of Cambridge,  
Wilberforce Road, Cambridge, CB3 0WA, U.K.

<sup>b</sup>Cavendish Laboratory (HEP),  
JJ Thomson Avenue, Cambridge, CB3 0HE, U.K.

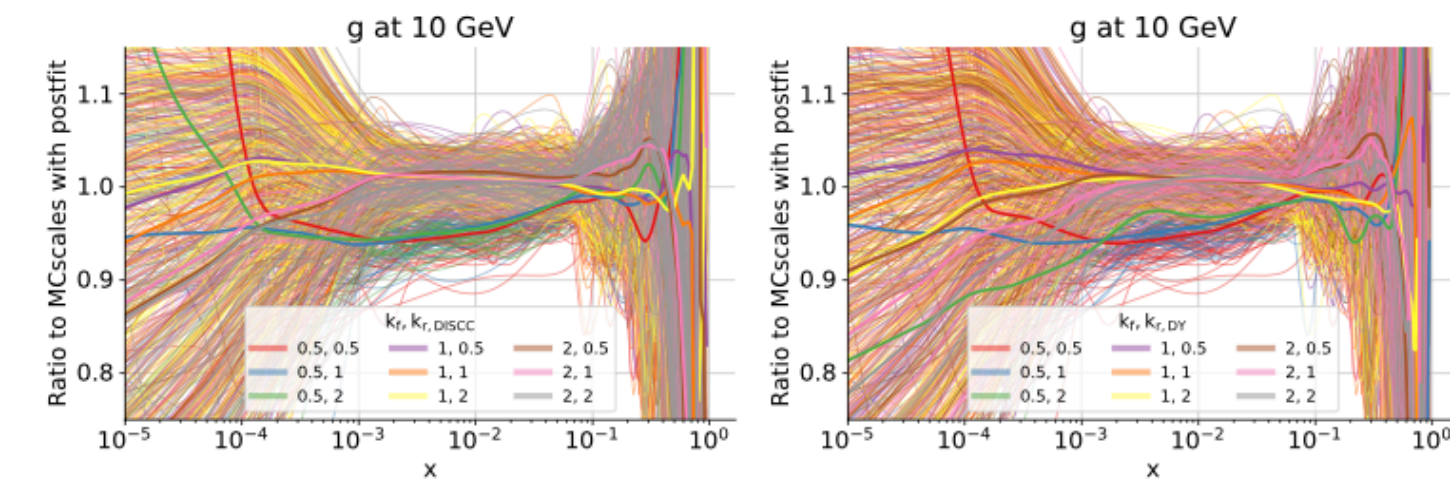
E-mail: [zk261@cam.ac.uk](mailto:zk261@cam.ac.uk), [mu227@cam.ac.uk](mailto:mu227@cam.ac.uk), [voisey@hep.phy.cam.ac.uk](mailto:voisey@hep.phy.cam.ac.uk)

**ABSTRACT:** We present the **MCscales** approach for **incorporating scale uncertainties in parton distribution functions** (PDFs). The new methodology builds on the Monte Carlo sampling for propagating experimental uncertainties into the PDF space that underlies the NNPDF approach, but it **extends it to the space of factorisation and renormalisation scales**. A **prior** probability is assigned to each scale combinations set in the theoretical predictions used to obtain each PDF replica in the Monte Carlo ensemble and a **posterior** probability is obtained by selecting replicas that satisfy fit-quality criteria. Our approach allows one to **exactly match the scale variations in the PDFs with those in the computation of the partonic cross sections**, thus accounting for the **full correlations between the two**. We illustrate the opportunities for **phenomenological exploration** made possible by our methodology for a **variety of LHC observables**. Sets of **PDFs enriched with scale information** are provided, along with a set of tools to use them.

**KEYWORDS:** Parton Distributions, Specific QCD Phenomenology

ARXIV EPRINT: [2207.07616](https://arxiv.org/abs/2207.07616)

JHEP03(2023)148



**Figure 4.** PDF replicas of the **MCscales** with **postfit** set, for the gluon at  $Q = 10$  GeV. Each replica is coloured according to its scale choice, where the numbers in the legend correspond to  $(k_f, k_r)$ , where  $k_r$  corresponds to the renormalisation scale for the DIS CC predictions (left panel) or to the one for the DY predictions (right panel). The colouring of the scales is done according to the scales of two different processes included in the fit: the left-hand plot shows the values of the scales for DIS CC and the right-hand plot shows them for DY. The bold lines indicate the average over all replicas for the corresponding scale choice. The plot is normalised to the central replica so that deviations from the central value are shown.

We now study the effect of the scale uncertainties at the level of the PDFs. Figure 5 compares the NNPDF3.1 baseline with the **MCscales** uniform prior set and the **MCscales** with **postfit** set. The gluon and the singlet PDFs are displayed along with their 68% C.L. error bands at  $Q = 10$  GeV. The plots are normalised to the NNPDF3.1 baseline so its central values sit along the  $x$ -axes. We see that including scale variations in the PDF sets, as is done in the **MCscales** PDF sets, leads to increased PDF uncertainties, as we would expect. In the  $x \in [10^{-4} - 10^{-2}]$  region the uncertainty broadening is much stronger for the singlet PDFs than for the gluon PDF. At very small  $x$ ,  $x \lesssim 10^{-4}$  this effect seems to generally be most pronounced, especially for the **MCscales** uniform prior. We see further that the uniform prior set leads to a general enhancement of the singlet PDFs, while for the gluon PDF the effect is much less marked. However in both cases, after **postfit** has been applied to the **MCscales** set based on an uniform prior, the general enhancement is no longer present and the increase in PDF uncertainties tends to become more symmetric.

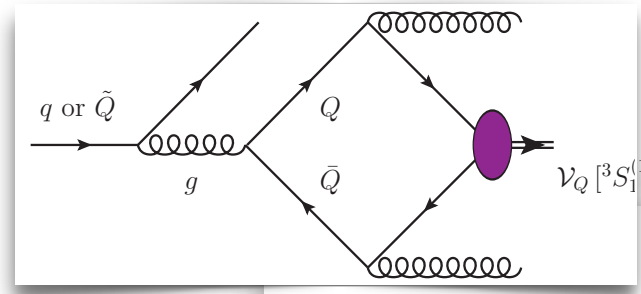
Comparing the NNPDF3.1 baseline and the **MCscales** with **postfit** set, we see the effect of scale variations once outliers have been sensibly removed. For each flavour the PDFs are compatible within uncertainties, with any shift in the central value induced by scale variations within the uncertainties of the NNPDF3.1 baseline. The shift in the central value appears to be most prominent in the data region for the gluon, where part of the reduction in the gluon PDF observed for the **MCscales** PDFs without **postfit** remains after their application.

A discussion concerning the comparison with the PDFs obtained in refs. [21, 22] using

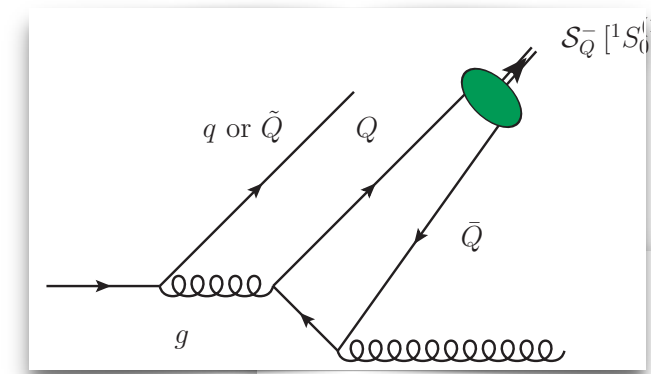
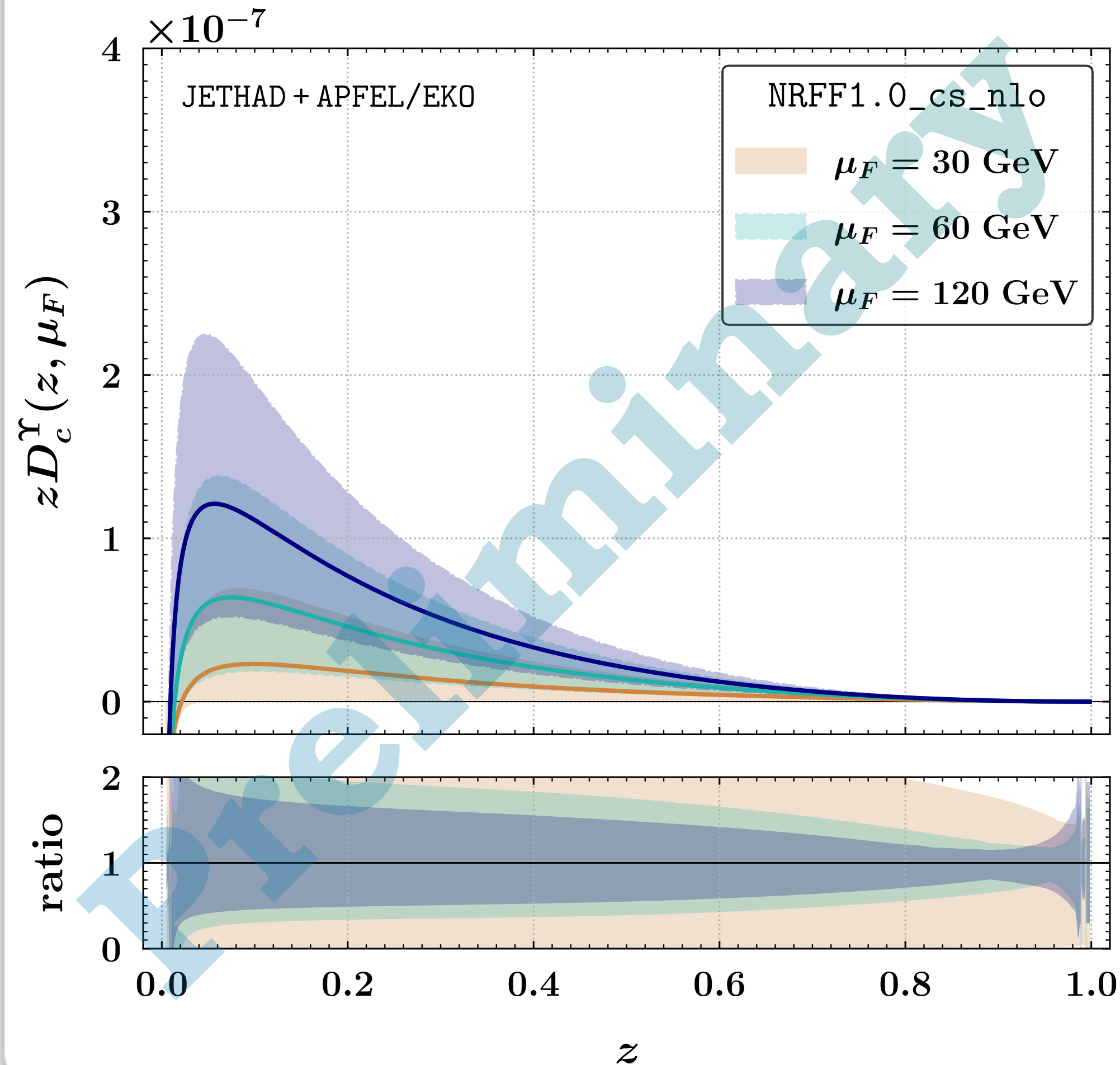
JHEP03(2023)148

# NRFF1.0: Charm fragmentation to bottomonia

## Vector $\Upsilon$

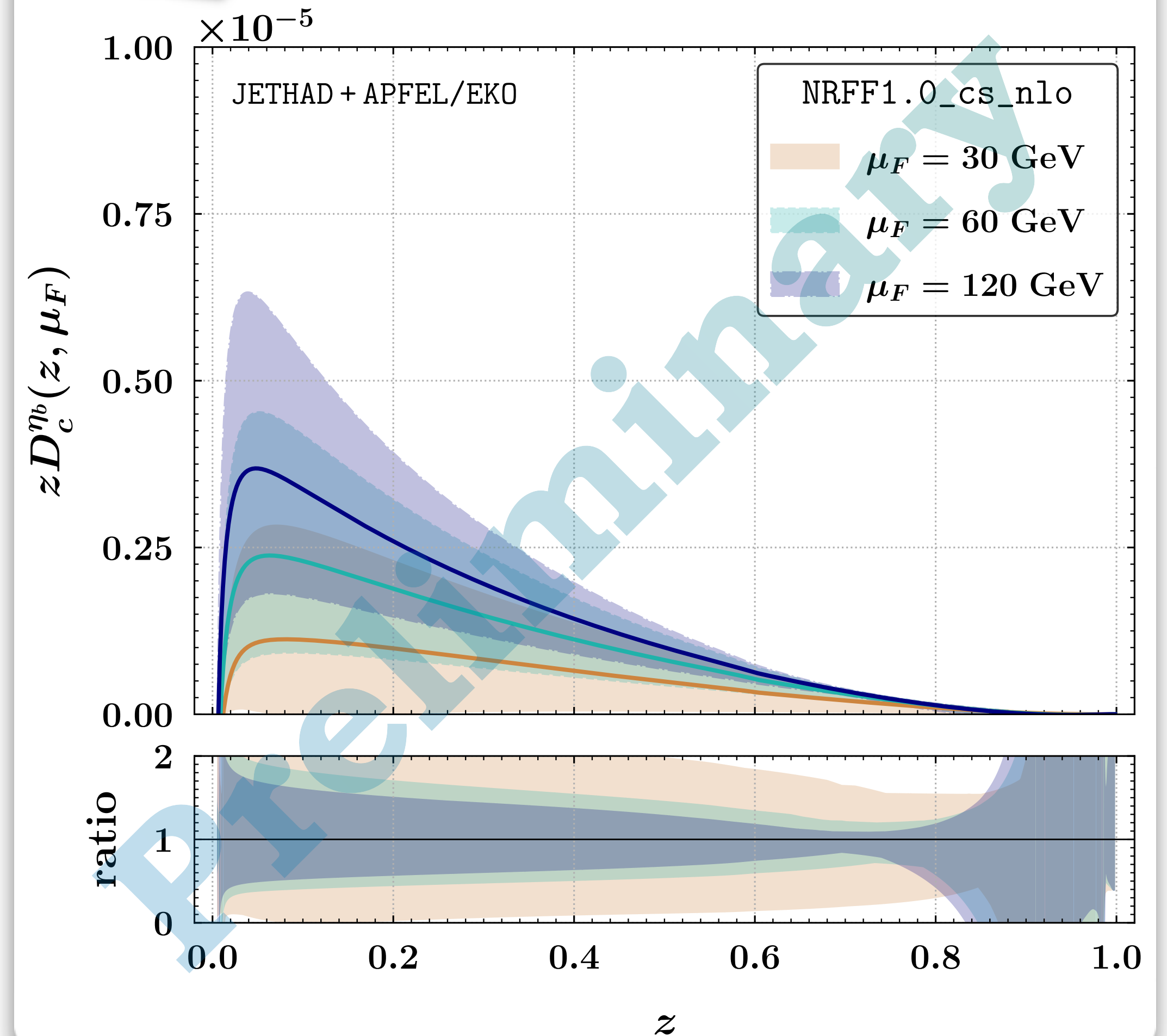


( $c \rightarrow \Upsilon$ ) fragmentation channel



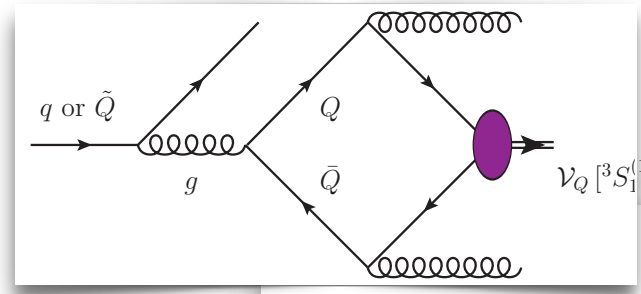
( $c \rightarrow \eta_b$ ) fragmentation channel

## Scalar $\eta_b$

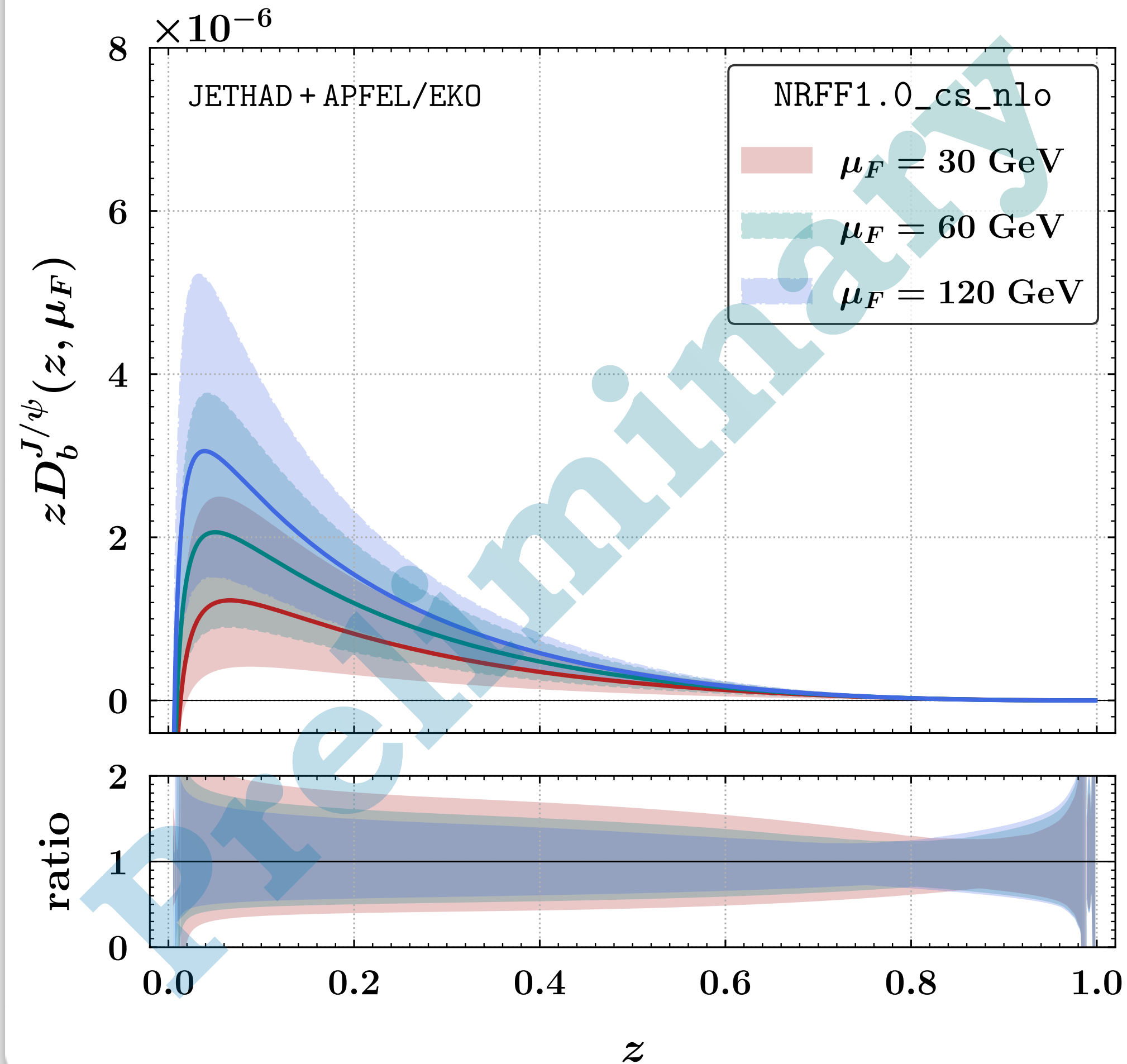


# NRFF1.0: Bottom fragmentation to charmonia

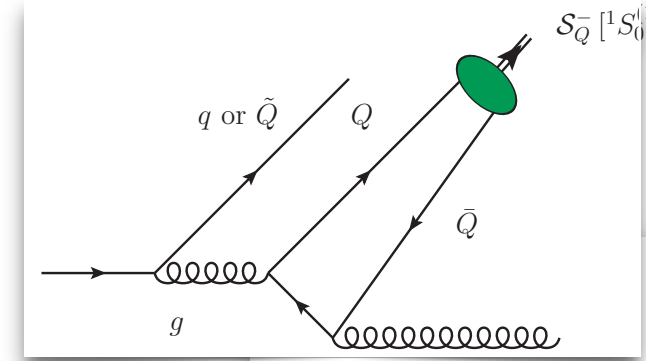
## Vector $J/\psi$



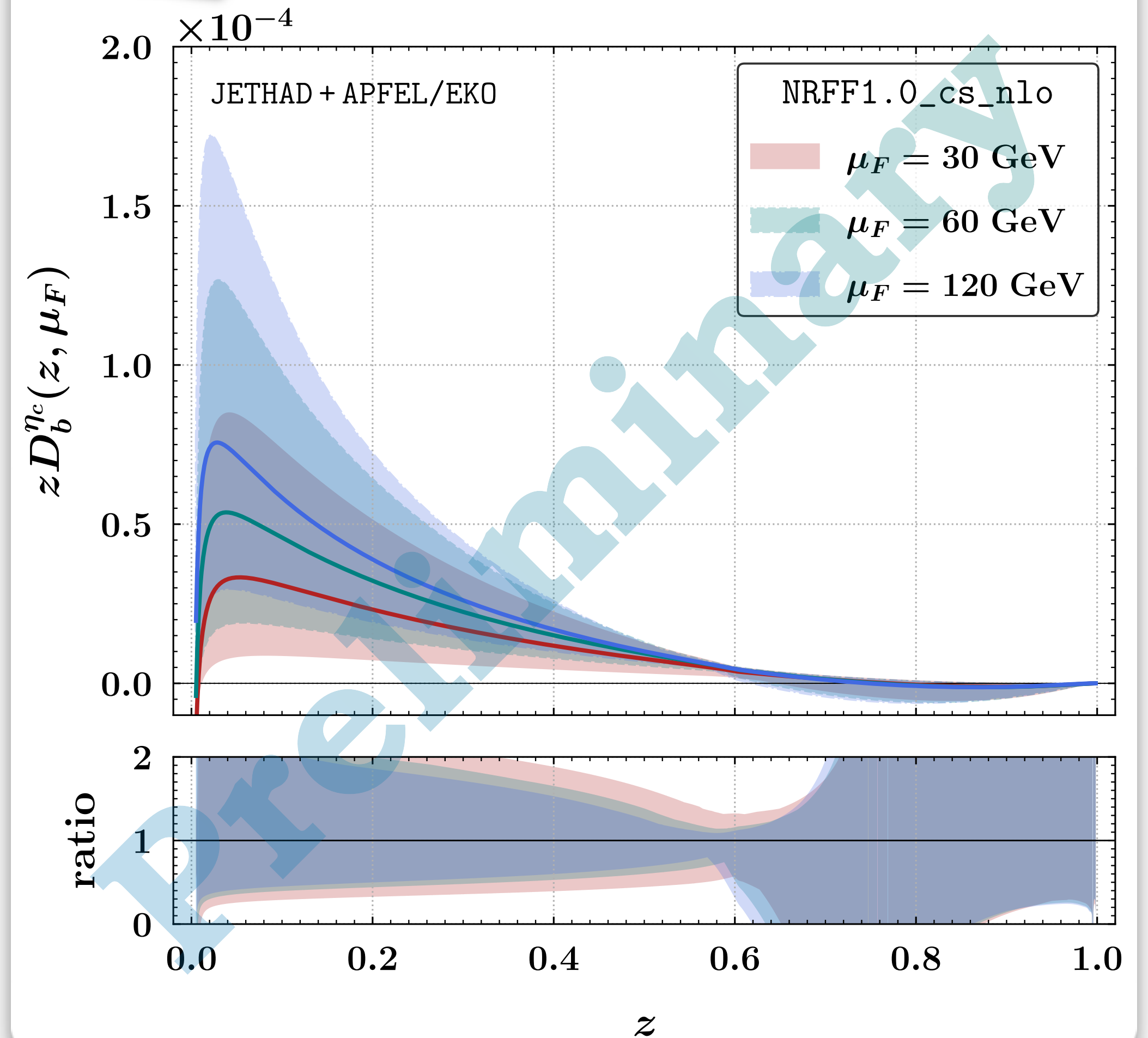
$(b \rightarrow J/\psi)$  fragmentation channel



## Scalar $\eta_c$

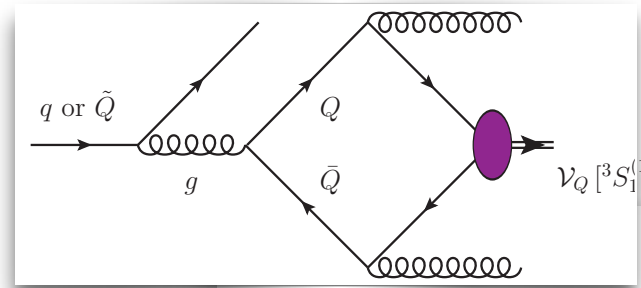


$(b \rightarrow \eta_c)$  fragmentation channel

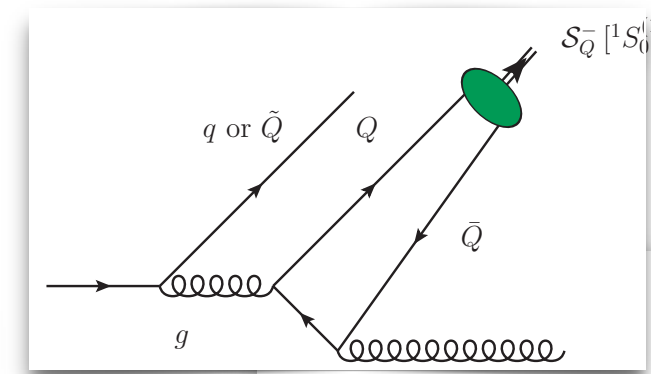
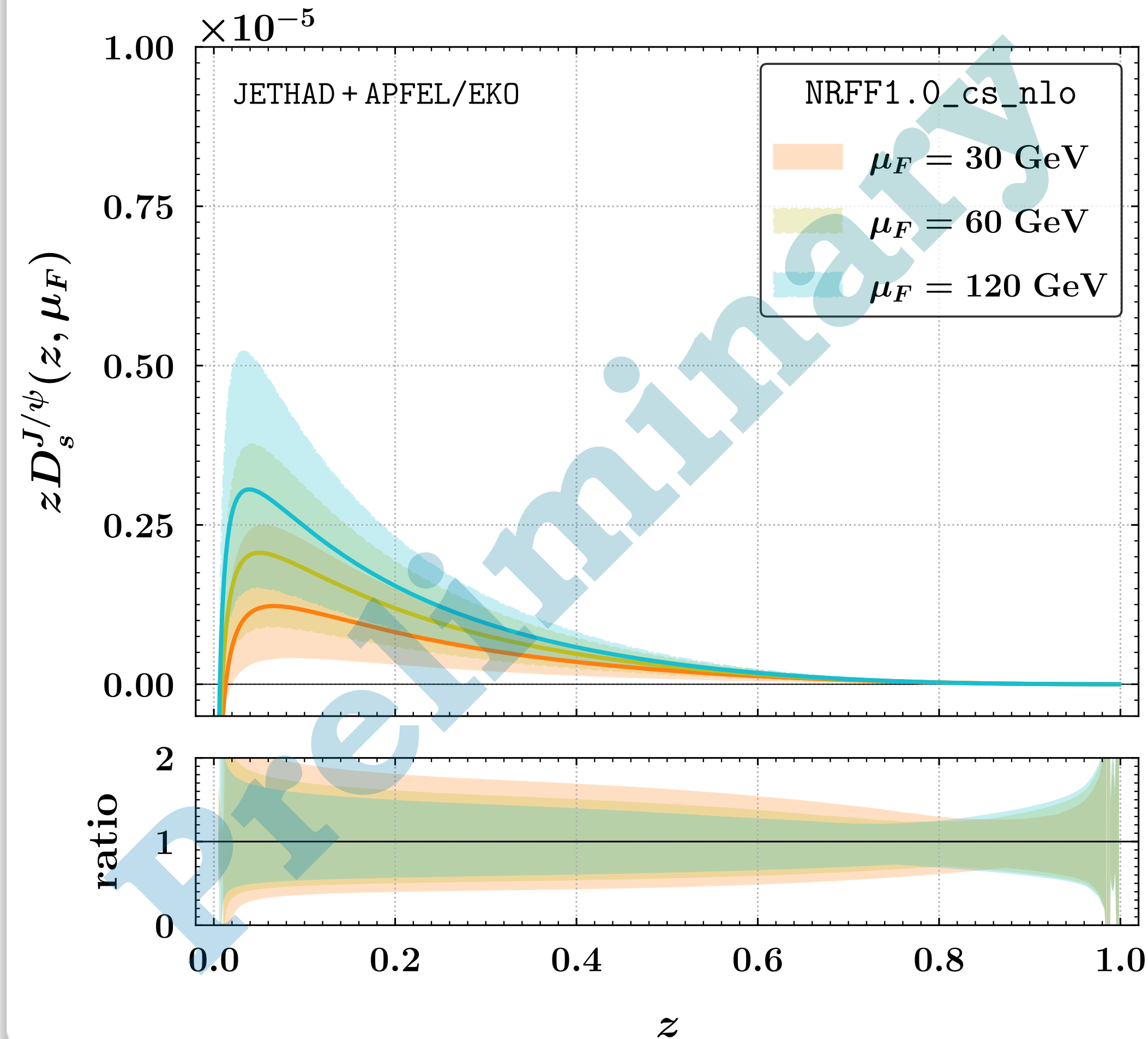


# NRFF1.0: Strange fragmentation to charmonia

## Vector $J/\psi$

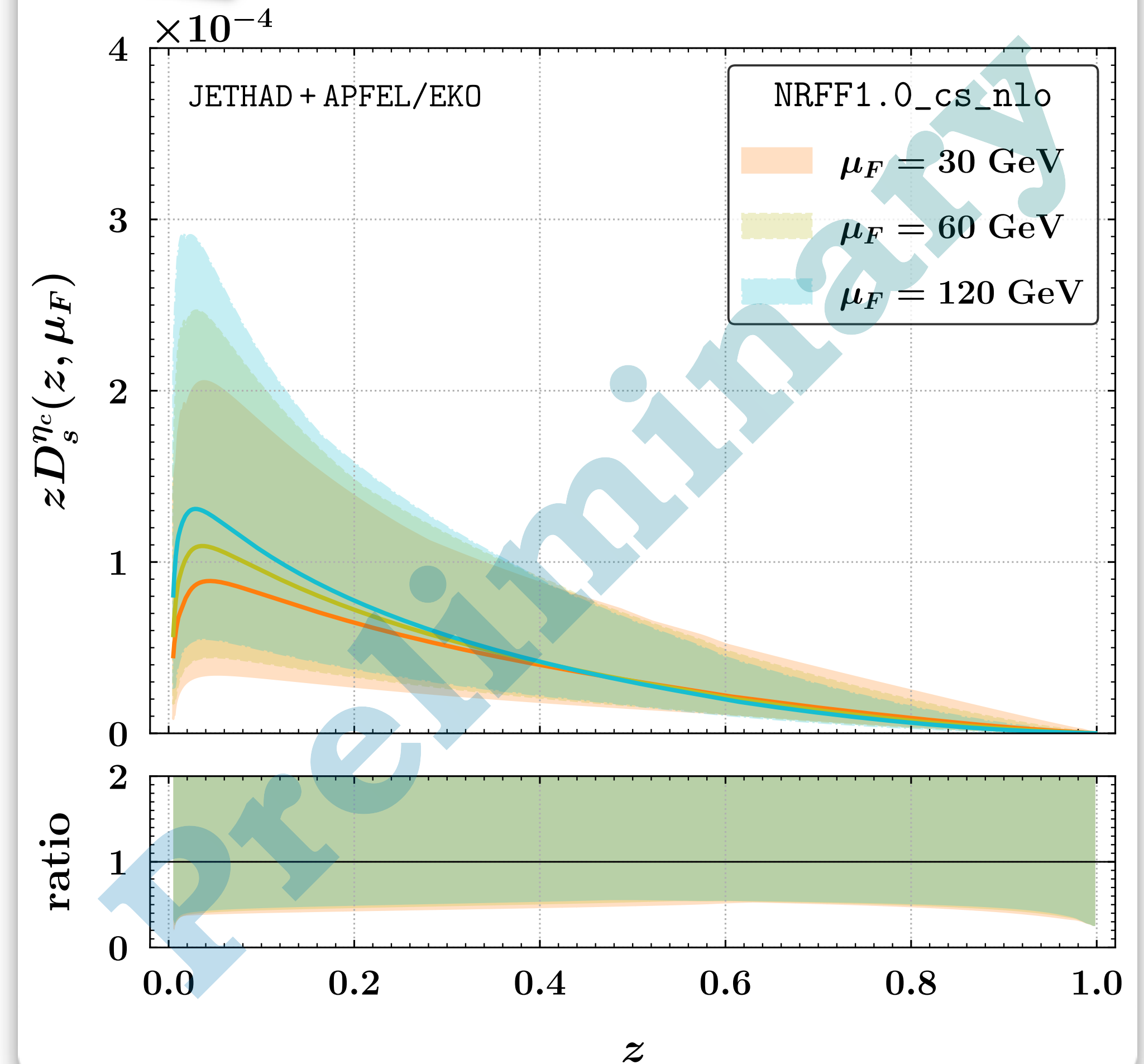


$(s \rightarrow J/\psi)$  fragmentation channel



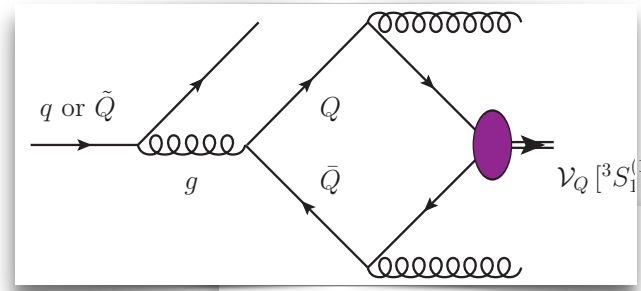
$(s \rightarrow \eta_c)$  fragmentation channel

## Scalar $\eta_c$

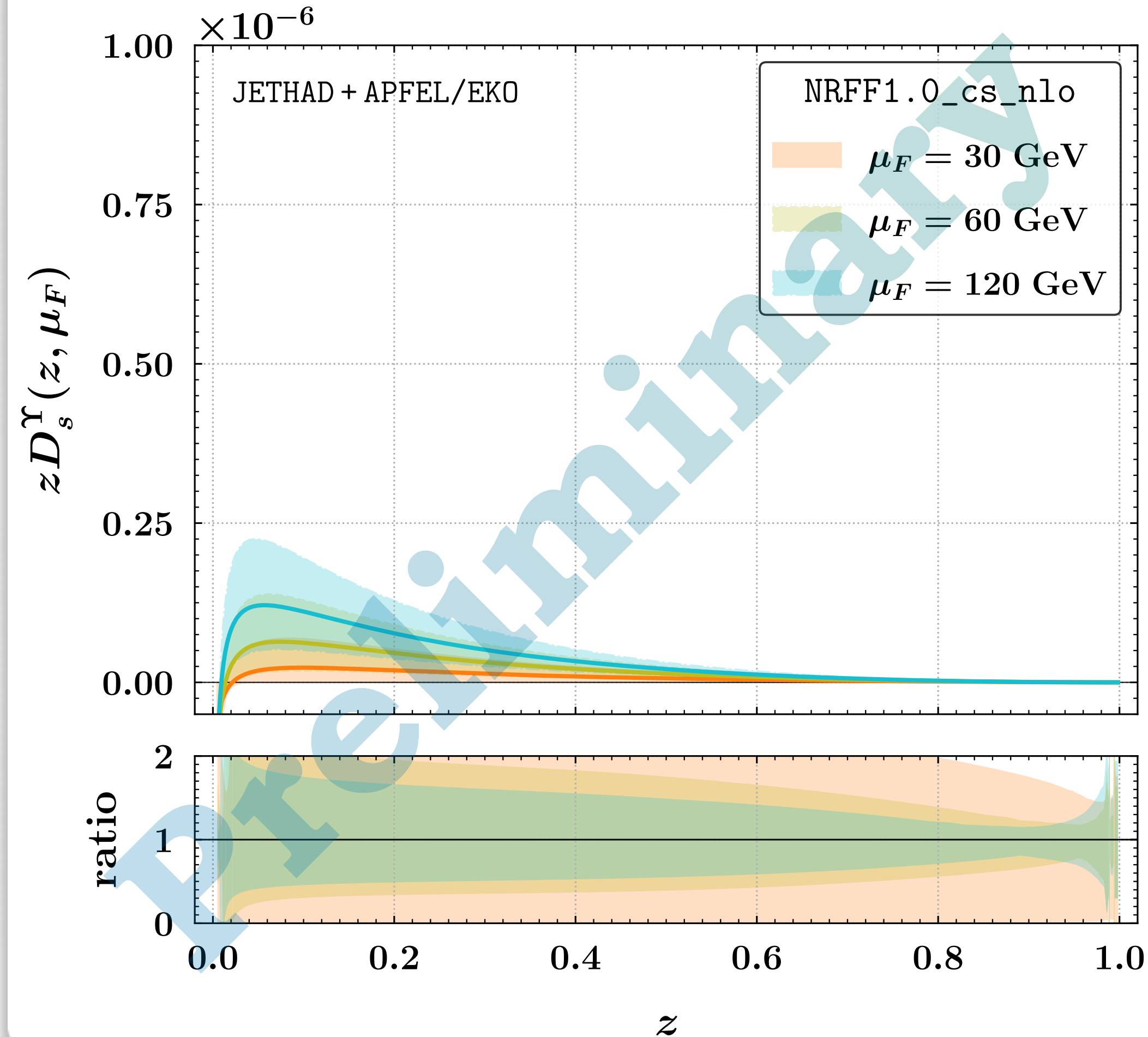


# NRFF1.0: Strange fragmentation to bottomonia

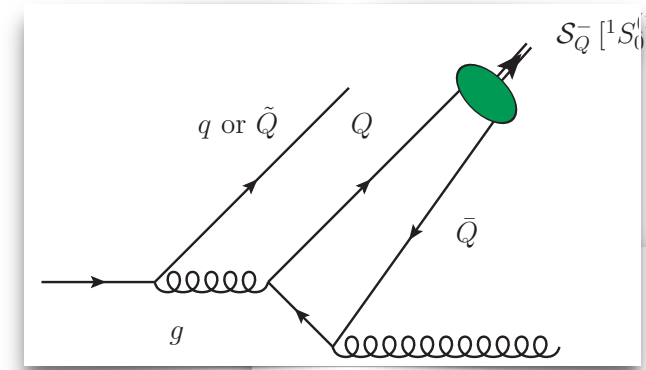
## Vector $\Upsilon$



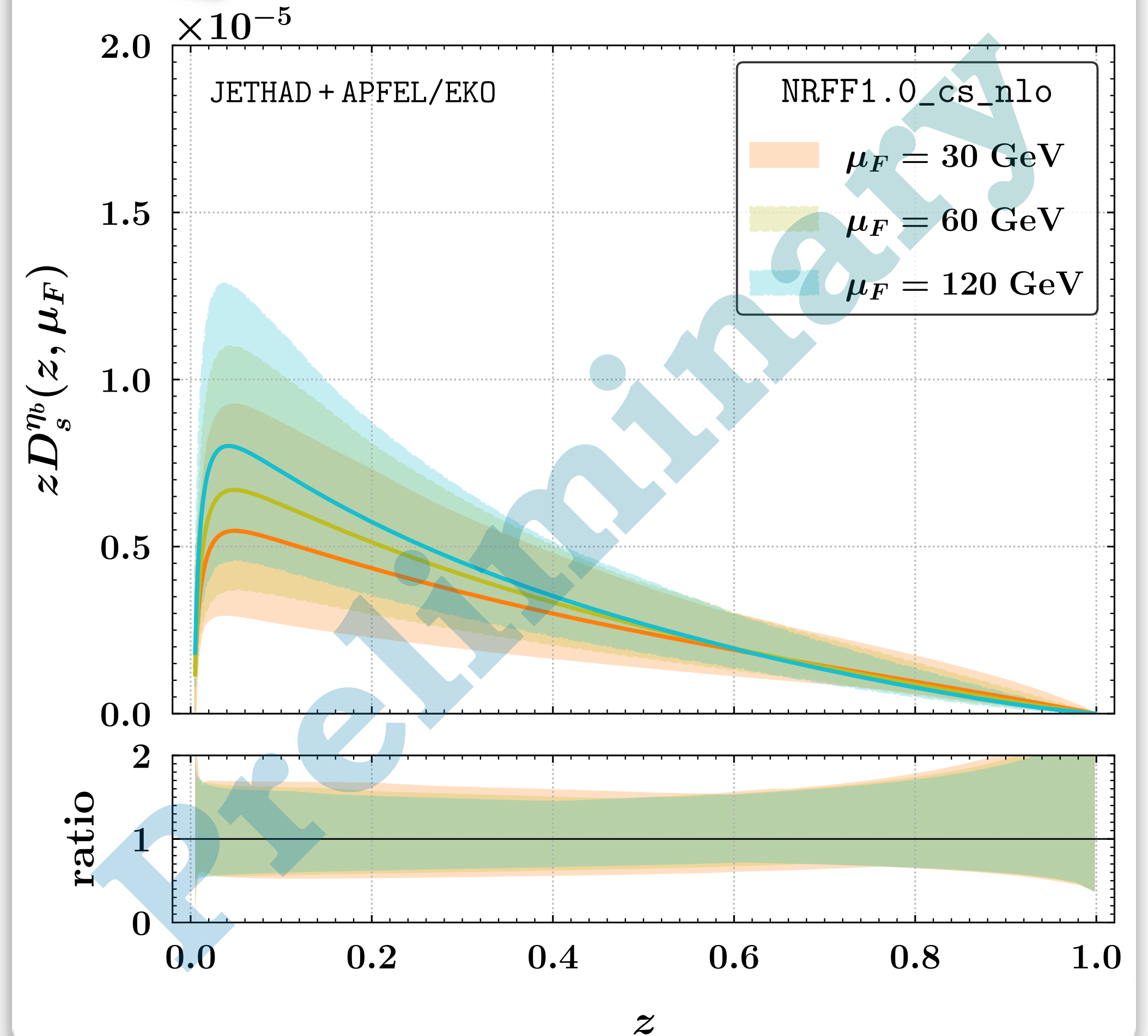
$(s \rightarrow \Upsilon)$  fragmentation channel



## Scalar $\eta_b$

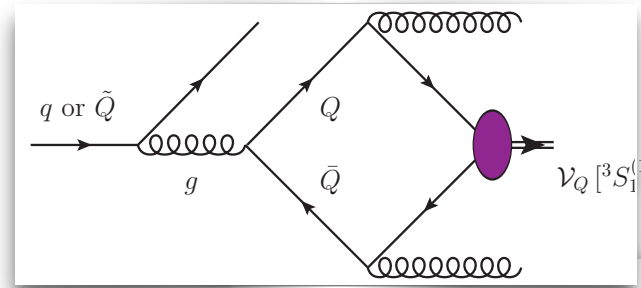


$(s \rightarrow \eta_b)$  fragmentation channel

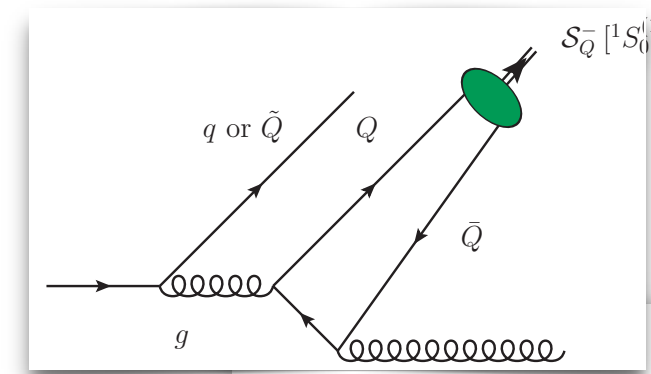
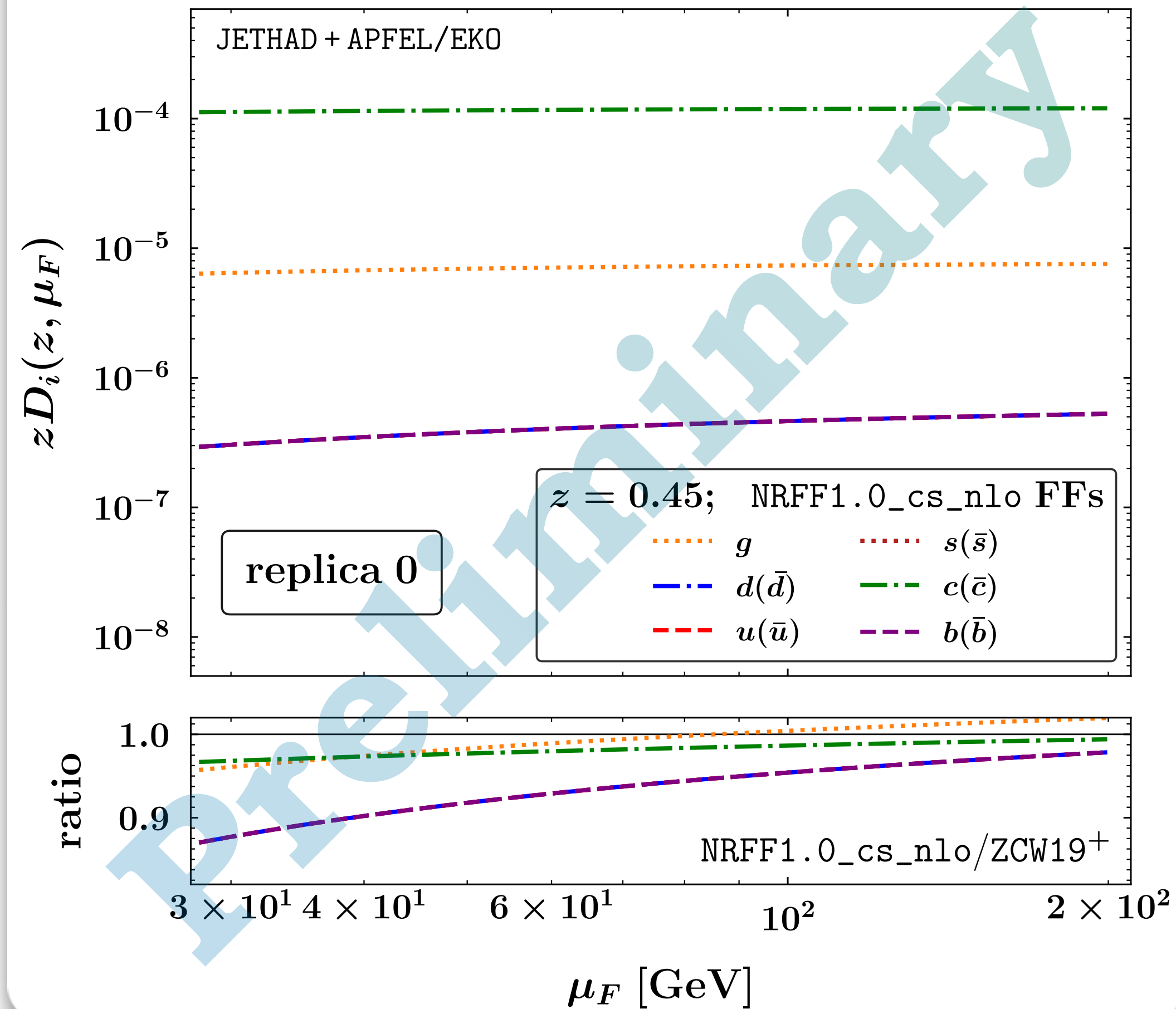


# NRFF1.0: Energy dependence

## Vector $J/\psi$

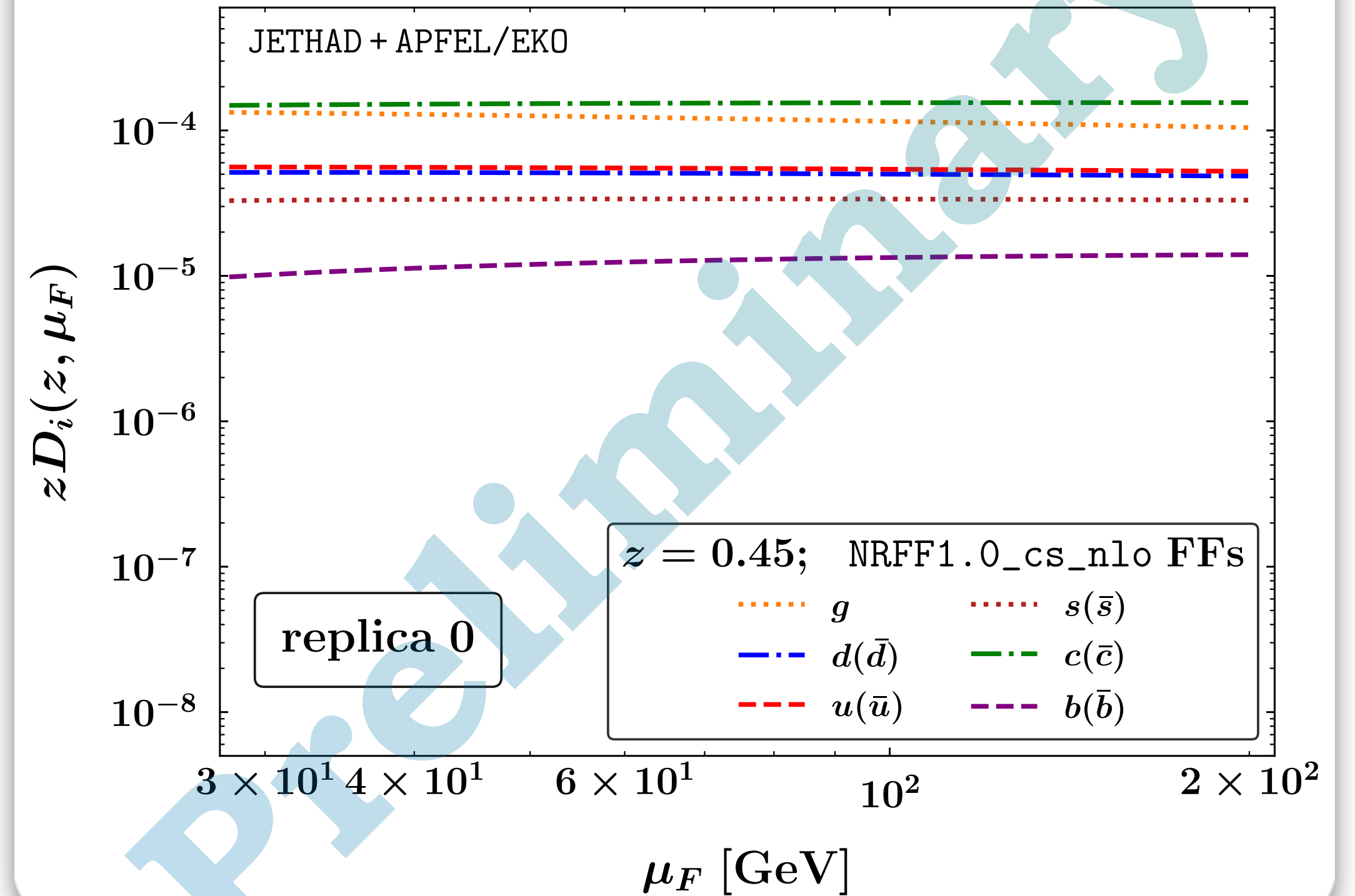


$J/\psi$  collinear FFs



## Scalar $\eta_c$

$\eta_c$  collinear FFs



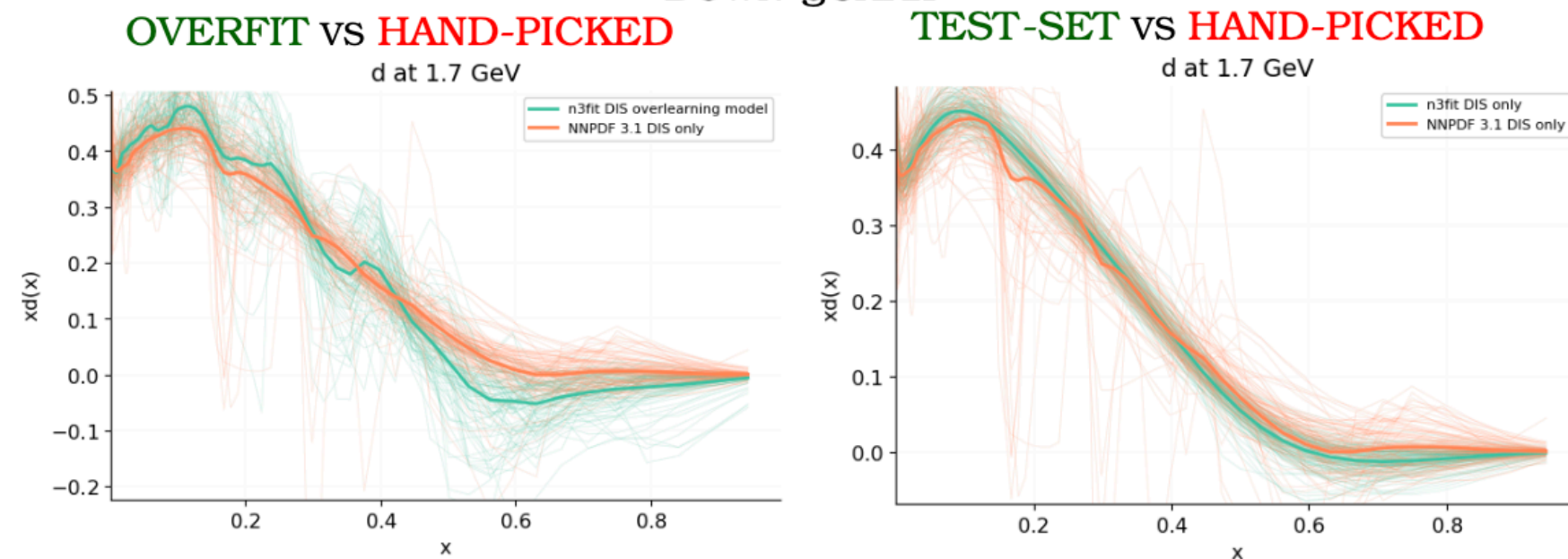


# Towards NRFF1.0: Quarkonium FF Kinetic Energy ?

## TEST SET RESULTS

- COMPLETELY UNCORRELATED TEST SET
- OPTIMIZE ON WEIGHTED AVERAGE OF VALIDATION AND TEST  
⇒ NO OVERLEARNING

### HYPEROPTIMIZED PDFs DOWN QUARK



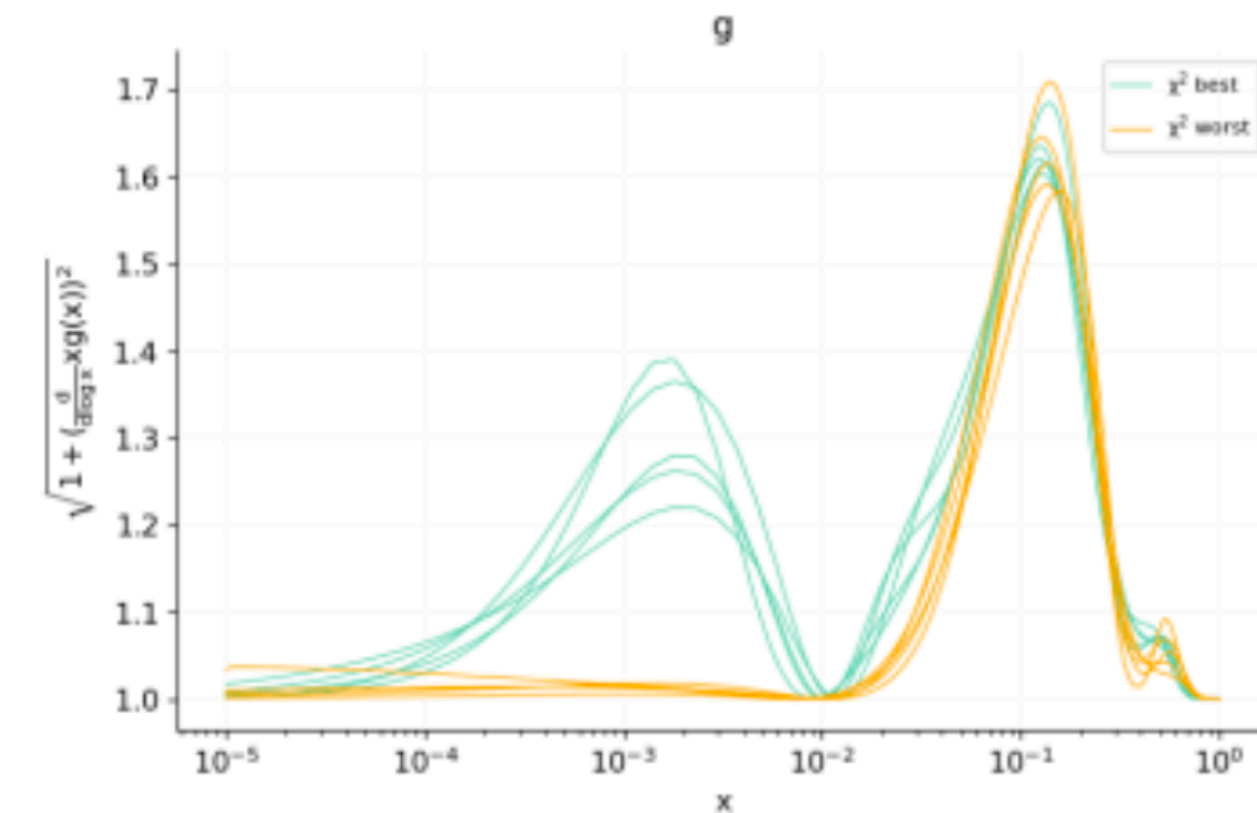
BUT WHO PICKS THE TEST SET?

## THE PDF KINETIC ENERGY

REPLICAS WITH LOWEST & HIGHEST LOSS TO CENTRAL DATA

$$KE = \sqrt{1 + \left( \frac{d}{d \ln x} x f(x, Q^2) \right)^2}$$

ARCLENGTH OF THE NN OUTPUT IN TERMS OF INPUT  
THE GLUON



- REPLICAS CLOSER TO CENTRAL DATA ⇒ MORE STRUCTURE
- HIGHER KINETIC ENERGY

## WHAT ABOUT

## QUARKONIUM

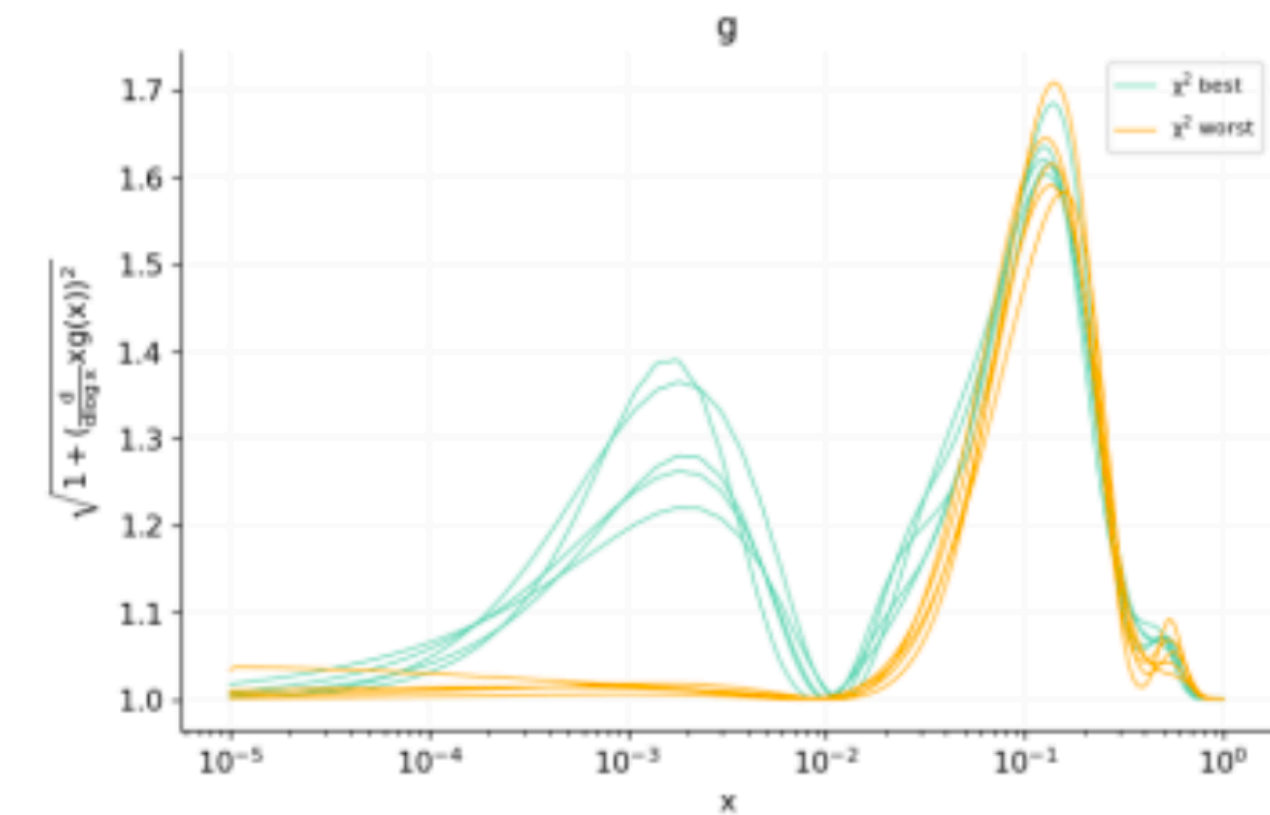
## FRAGMENTATION

## KINETIC ENERGY (QF-KE) ?

THE PDF KINETIC ENERGY  
REPLICAS WITH LOWEST & HIGHEST LOSS TO CENTRAL DATA

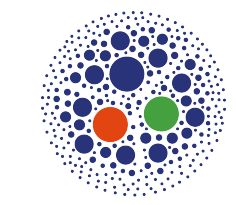
$$KE = \sqrt{1 + \left( \frac{d}{d \ln x} x f(x, Q^2) \right)^2}$$

ARCLENGTH OF THE NN OUTPUT IN TERMS OF INPUT  
THE GLUON

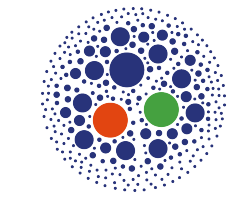


- REPLICAS CLOSER TO CENTRAL DATA  $\Rightarrow$  MORE STRUCTURE
- HIGHER KINETIC ENERGY

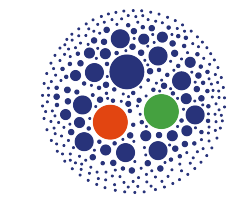
# What is a quarkonium?



Quarkonia  $\rightarrow$  mesons with a heavy quark & its antiquark  $\rightarrow |Q\rangle \equiv |Q\bar{Q}\rangle$

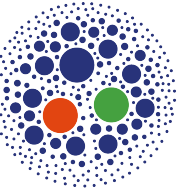
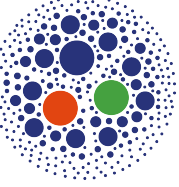



They owe the name to the analogy with the positronium  $\rightarrow |\mathcal{P}\rangle \equiv |e^+e^-\rangle$

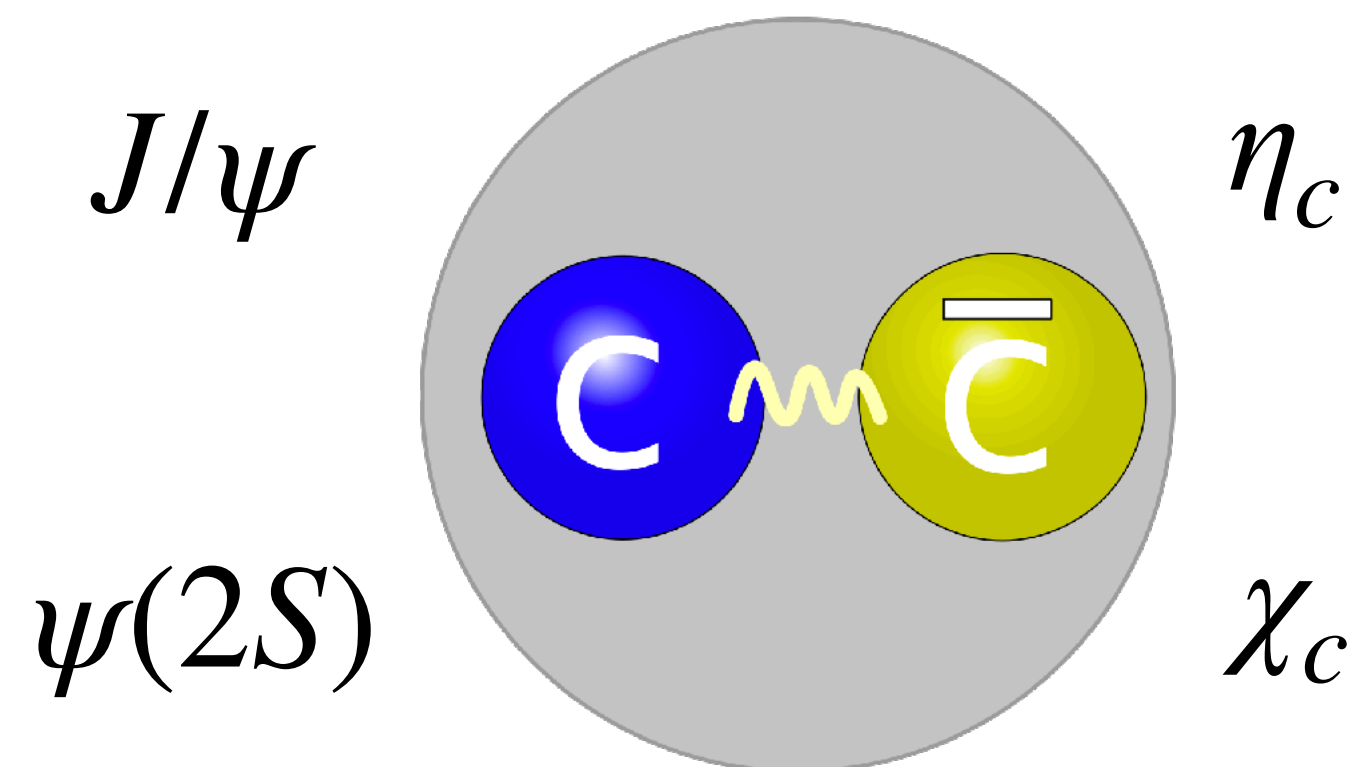


A quarkonium is an electrically neutral particle & is also its own antiparticle

# What is a quarkonium?

-  **Quarkonia** → mesons with a heavy quark & its antiquark →  $|Q\rangle \equiv |Q\bar{Q}\rangle$
-  They owe the name to the analogy with the **positronium** →  $|\mathcal{P}\rangle \equiv |e^+e^-\rangle$
-  A quarkonium is an electrically neutral particle & is also its own antiparticle

## Charmonia

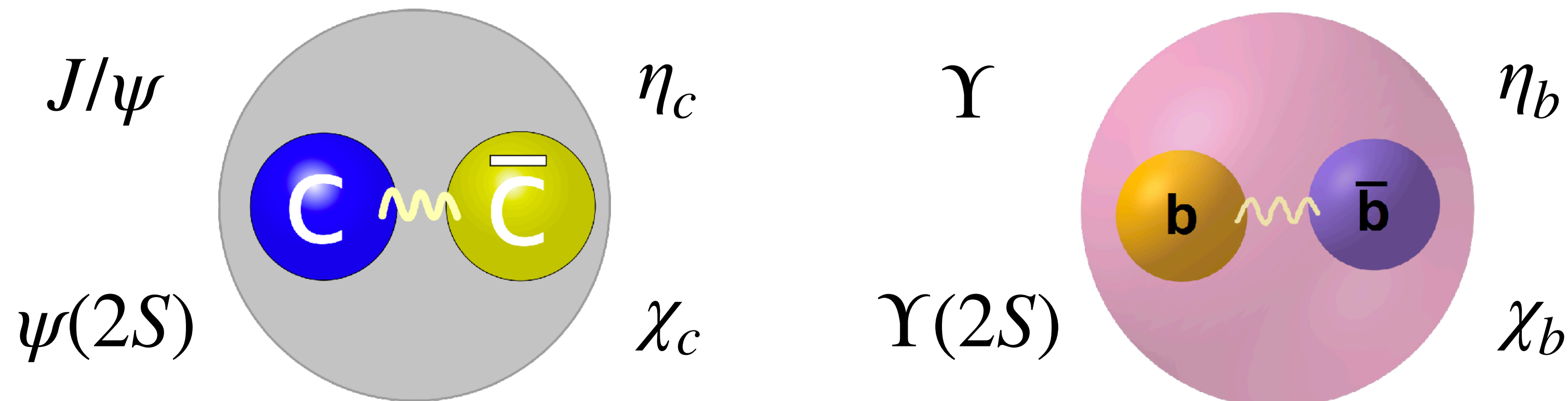


# What is a quarkonium?

- Quarkonia → mesons with a heavy quark & its antiquark →  $|Q\rangle \equiv |Q\bar{Q}\rangle$
- They owe the name to the analogy with the positronium →  $|\mathcal{P}\rangle \equiv |e^+e^-\rangle$
- A quarkonium is an electrically neutral particle & is also its own antiparticle

## Charmonia

## Bottomonia



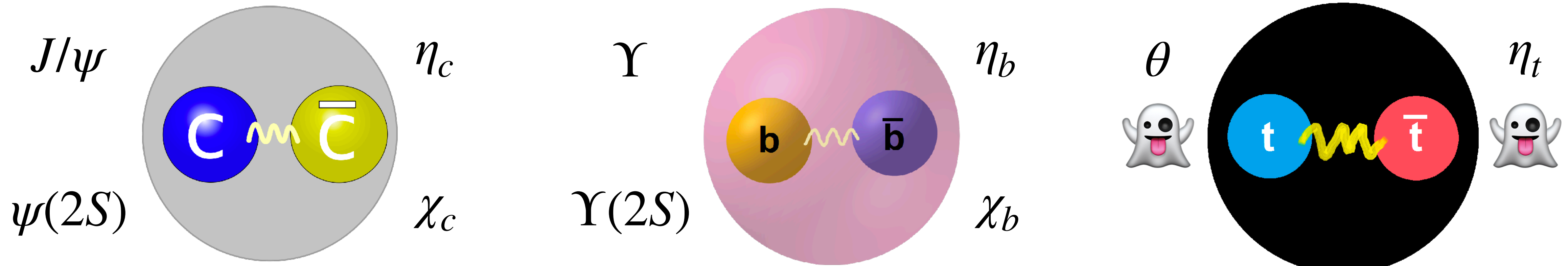
# What is a quarkonium?

- Quarkonia → mesons with a heavy quark & its antiquark →  $|Q\rangle \equiv |Q\bar{Q}\rangle$
- They owe the name to the analogy with the positronium →  $|\mathcal{P}\rangle \equiv |e^+e^-\rangle$
- A quarkonium is an electrically neutral particle & is also its own antiparticle

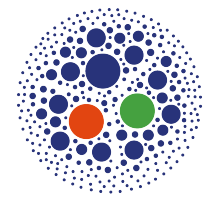
## Charmonia

## Bottomonia

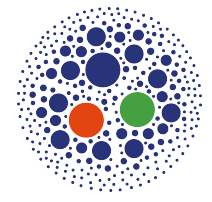
## Toponia



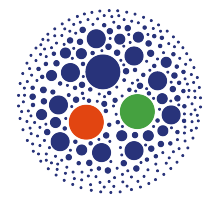
# What is a quarkonium?



**Quarkonia** → mesons with a heavy quark & its antiquark →  $|Q\rangle \equiv |Q\bar{Q}\rangle$



They owe the name to the analogy with the **positronium** →  $|\mathcal{P}\rangle \equiv |e^+e^-\rangle$

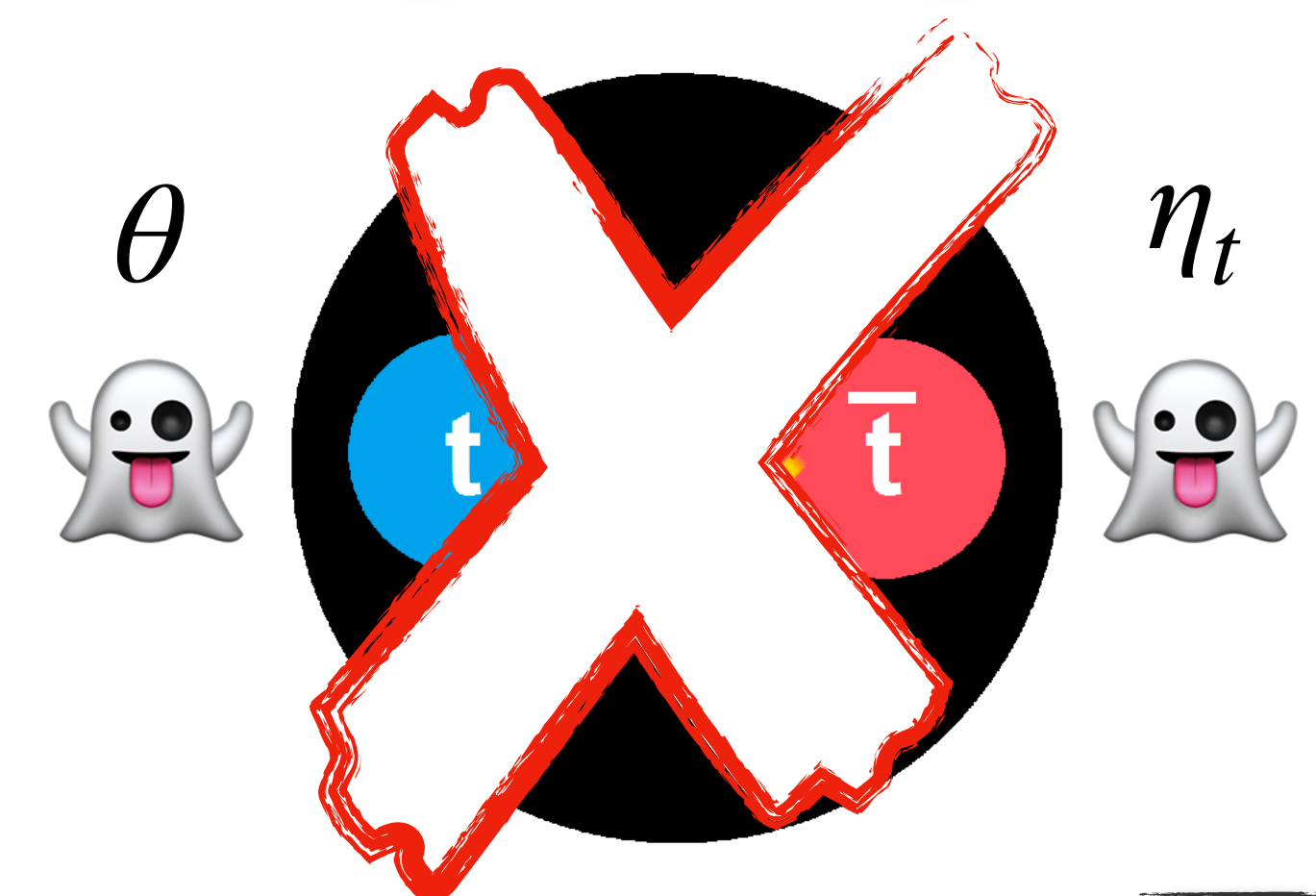
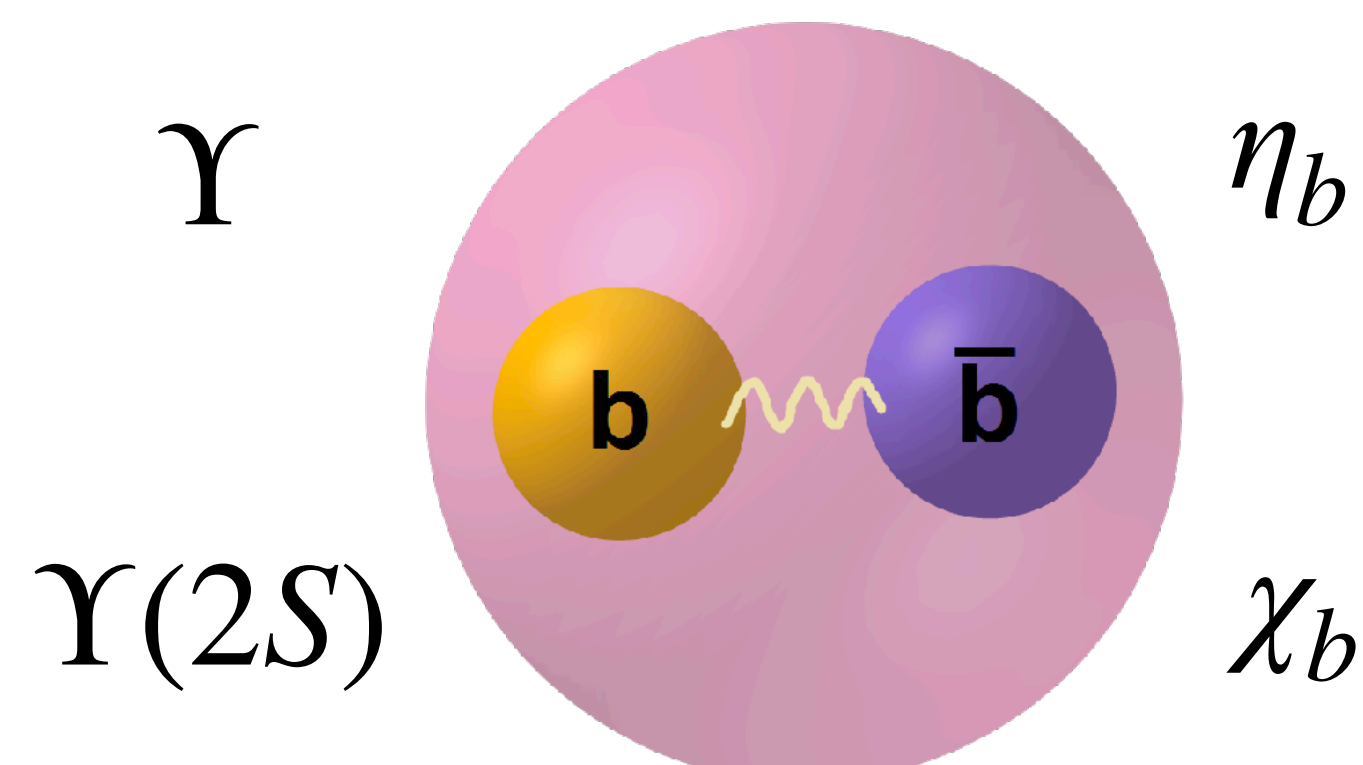
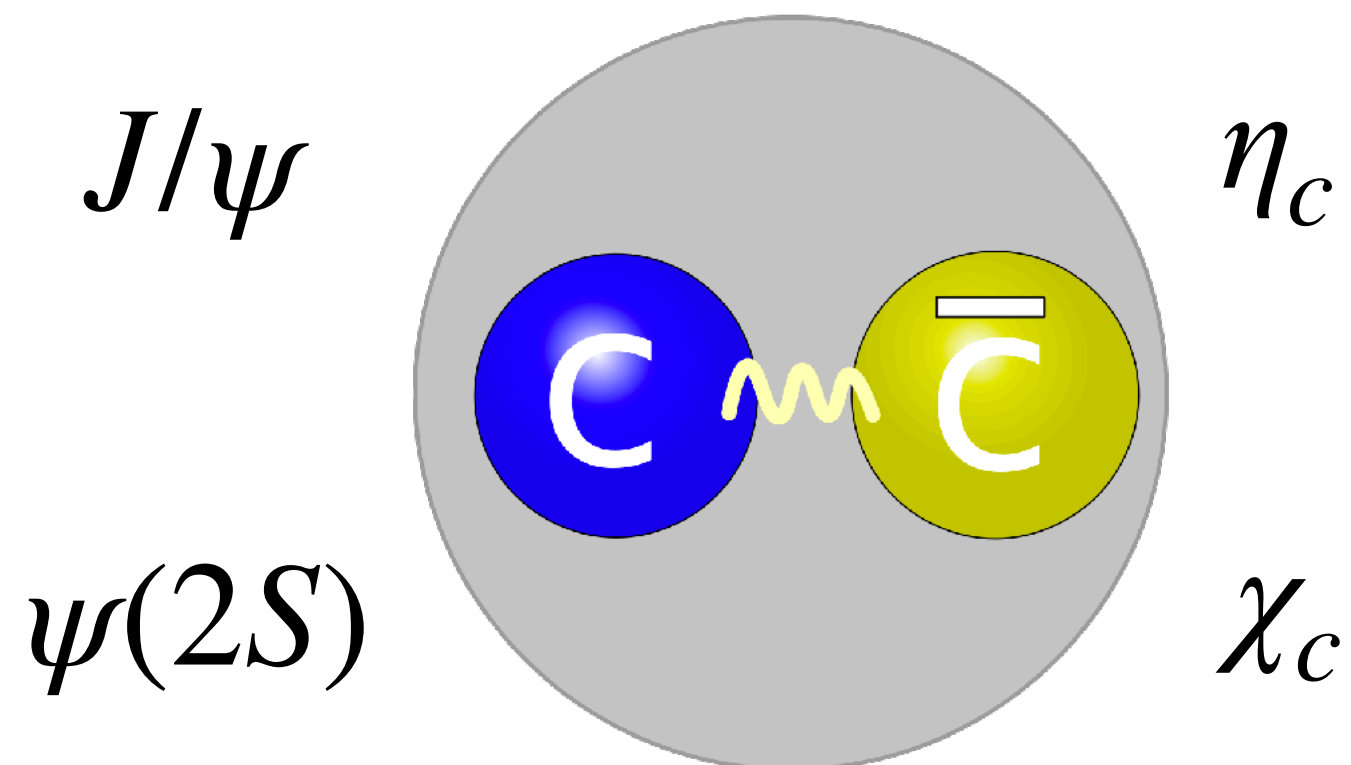


A quarkonium is an electrically neutral particle & is also its own antiparticle

## Charmonia

## Bottomonia

## Toponia



# Quarkonium studies: Progresses & challenges



Quarkonium discovery (1974): SLAC & BNL (🇺🇸), then Frascati (🇮🇹) →  $J/\psi$



# Quarkonium studies: Progresses & challenges



Quarkonium discovery (1974): SLAC & BNL (🇺🇸), then Frascati (🇮🇹) →  $J/\psi$



Proof of the existence of the **charm** quark ( $c$ )...



...and of quarks as real particles and not as mathematical artifacts

# Quarkonium studies: Progresses & challenges



Quarkonium discovery (1974): SLAC & BNL (🇺🇸), then Frascati (🇮🇹) →  $J/\psi$



Proof of the existence of the **charm** quark ( $c$ )...



...and of quarks as real particles and not as mathematical artifacts



GIM mechanism (1970) → **charm** to explain electroweak flavor rotation



Proof of asymptotic freedom & confinement ←  $\psi(2S)$  resonance

# Quarkonium studies: Progresses & challenges



Quarkonium discovery (1974): SLAC & BNL (🇺🇸), then Frascati (🇮🇹) →  $J/\psi$



Proof of the existence of the **charm** quark ( $c$ )...



...and of quarks as real particles and not as mathematical artifacts



GIM mechanism (1970) → **charm** to explain electroweak flavor rotation



Proof of asymptotic freedom & confinement ←  $\psi(2S)$  resonance



Quarkonia → easy to measure, difficult to understand

# Spectroscopic notation for quarkonia

Spin

Color: Singlet (CS) or Octet (CO)

$$[n] \equiv 2S+1 L (C) J$$

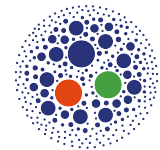
Orbital angular momentum

Total angular momentum


$$J = L + S$$

Backup

# Parton Distribution Functions & Fragmentation Functions

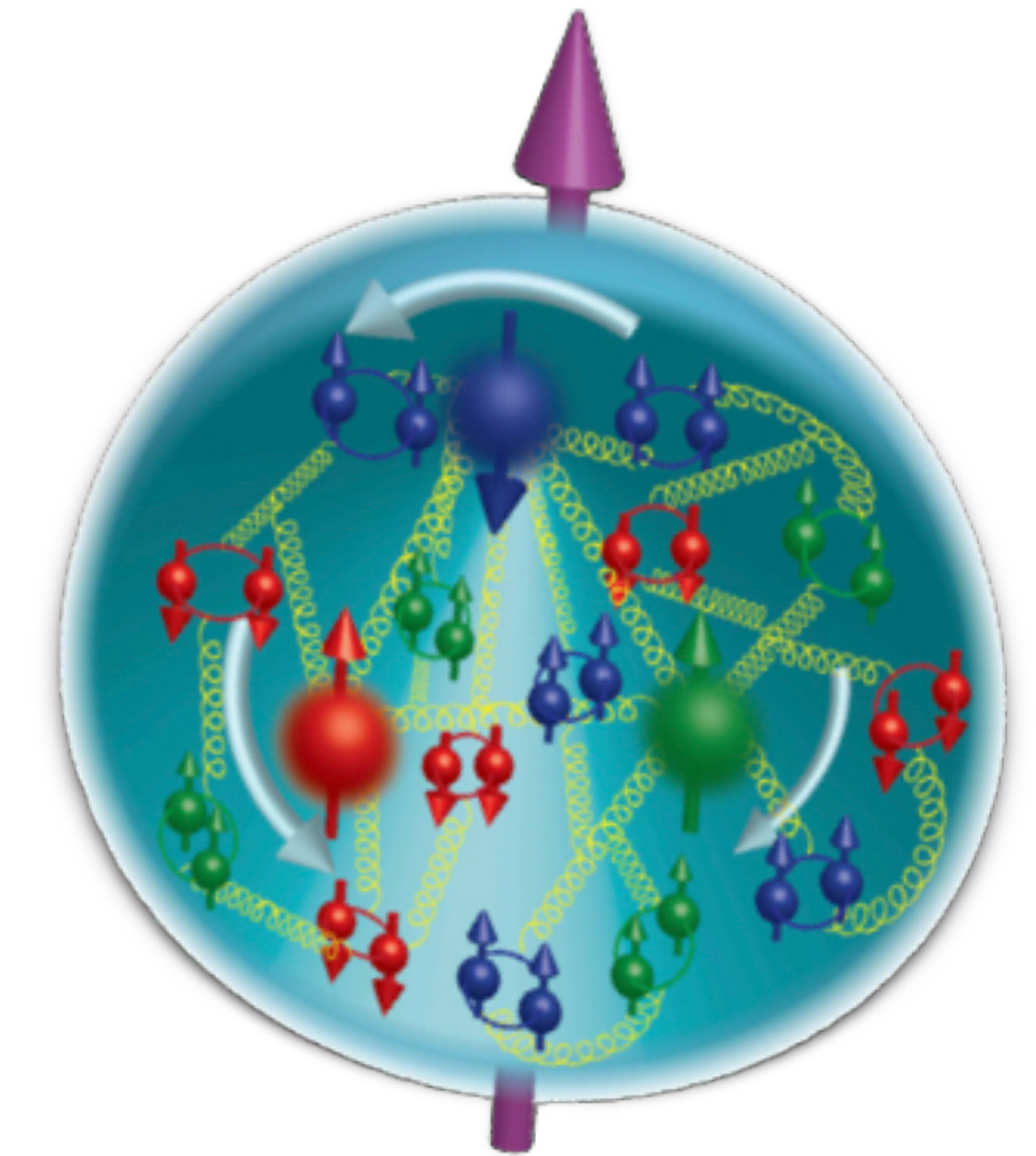
 **PDFs & FFs** → relevant for the search of **New Physics** from a **precision background**

→ ...crucial role in the understanding and **exploration** of **QCD**

 Describe the internal structure of the nucleon (PDFs) and the dynamic formation of hadrons (FFs)

 **Nonperturbative** objects that enter the expression of cross sections

 Can be *extracted* from experiments via *global fits*



# Parton Distribution Functions & Fragmentation Functions

PDFs & FFs → relevant for the search of **New Physics** from a **precision background**

→ ...crucial role in the understanding and **exploration** of **QCD**

Describe the internal structure of the nucleon (PDFs) and the dynamic formation of hadrons (FFs)

**Nonperturbative** objects that enter the expression of cross sections

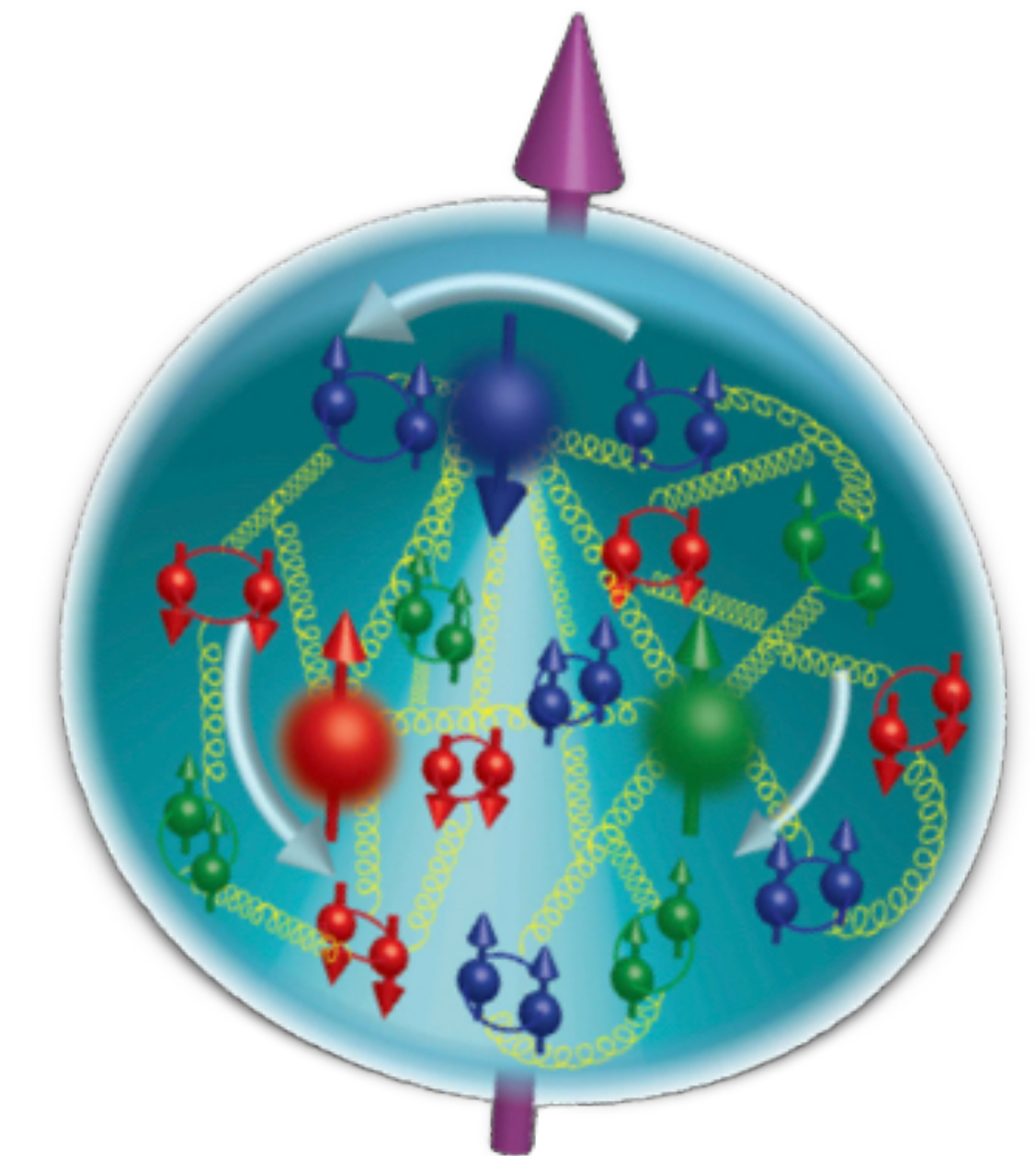
Can be *extracted* from experiments via *global fits*

Several types of functions (**1D collinear**, 3D TMD, 3D GPD, ...)

Follow from different **factorization theorems**

Exhibit peculiar **universality properties**

Obey distinct **evolution equations**



# The JETHAD technology

## High-energy resummation

Hunting BFKL

in semi-hard reactions

Mueller-Navelet, light hadrons

ERIS super-module

$$\alpha_s \ln(s) \lesssim 1$$



[\[Eur. Phys. J. C 81 \(2021\) 8, 691\]](#)

[\[Phys. Rev. D 105 \(2022\) 11, 114008\]](#)

**Backup**

# The JETHAD technology

## High-energy resummation

### Hunting BFKL

in semi-hard reactions

Mueller-Navelet, light hadrons  
ERIS super-module

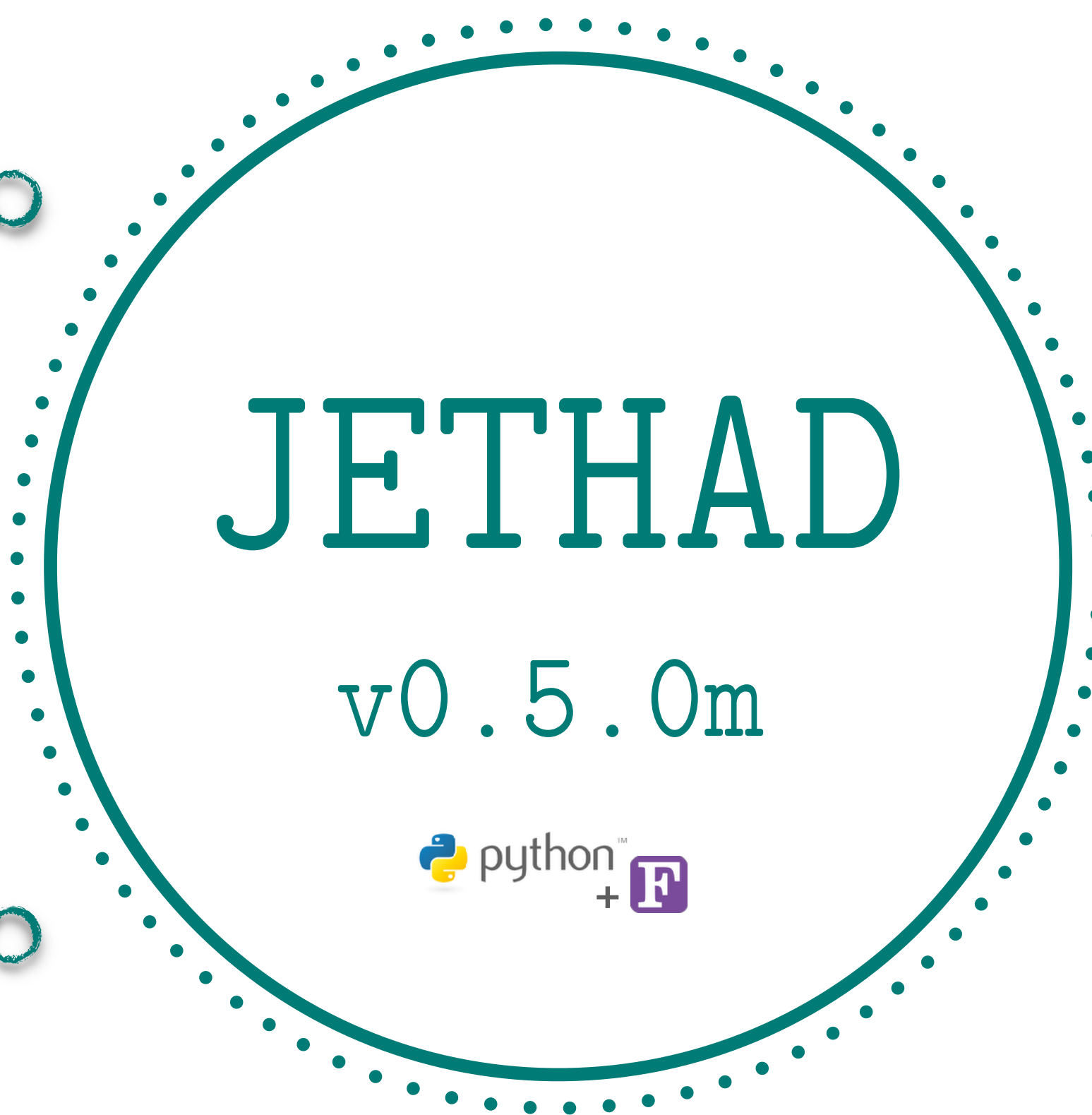
$$\alpha_s \ln(s) \lesssim 1$$

ERIS,  $\Delta$ naumis super-modules  
Higgs + jet, weak bosons

## High-energy resummation

### Matching NLL/NLO

In Higgs + jet at the LHC



[\[Eur. Phys. J. C 81 \(2021\) 8, 691\]](#)

[\[Phys. Rev. D 105 \(2022\) 11, 114008\]](#)

**Backup**



# The JETHAD technology

## High-energy resummation

### Hunting BFKL

in semi-hard reactions

Mueller-Navelet, light hadrons  
ERIS super-module

$$\alpha_s \ln(s) \lesssim 1$$

ERIS,  $\Delta$ varis super-modules  
Higgs + jet, weak bosons

## High-energy resummation

### Matching NLL/NLO

In Higgs + jet at the LHC

# JETHAD

v0.5.0m



- [\[Eur. Phys. J. C 81 \(2021\) 8, 691\]](#)
- [\[Phys. Rev. D 105 \(2022\) 11, 114008\]](#)

Forward Drell-Yan, onium, Higgs  
LExA, HATHOR super-modules

## Proton structure

Small-x UGD  
Gluon TMD PDFs

**Backup**

# The JETHAD technology

## High-energy resummation

Hunting **BFKL**  
in semi-hard reactions

Mueller-Navelet, light hadrons  
ERIS super-module

$$\alpha_s \ln(s) \lesssim 1$$

ERIS,  $\mathcal{A}_{\text{Navelet}}$  super-modules  
Higgs + jet, weak bosons

## High-energy resummation

Matching **NLL/NLO**  
In Higgs + jet at the LHC



Quarkonium studies  
from low to high  $p_T$   
**NRFF1.0** onium FFs

Vectors & pseudoscalars  
JETHAD + DGLAP evolution operators

Forward Drell-Yan, onium, Higgs  
LExA, HATHOR super-modules

## Proton structure

Small-x UGD  
Gluon TMD PDFs

# JETHAD

v0.5.0m



- [\[Eur. Phys. J. C 81 \(2021\) 8, 691\]](#)
- [\[Phys. Rev. D 105 \(2022\) 11, 114008\]](#)

**Backup**

# The JETHAD technology

## High-energy resummation

Hunting **BFKL**  
in semi-hard reactions

Mueller-Navelet, light hadrons  
ERIS super-module

$$\alpha_s \ln(s) \lesssim 1$$

ERIS,  $\Delta_{\text{Navelet}}$  super-modules  
Higgs + jet, weak bosons

## High-energy resummation

Matching **NLL/NLO**  
In Higgs + jet at the LHC



Quarkonium studies  
from low to high  $p_T$   
**NRFF1.0** onium FFs

Vectors & pseudoscalars  
JETHAD + DGLAP evolution operators



Forward Drell-Yan, onium, Higgs  
LExA, HATHOR super-modules

## Proton structure

Small-x UGD  
Gluon TMD PDFs

[\[Eur. Phys. J. C 81 \(2021\) 8, 691\]](#)  
[\[Phys. Rev. D 105 \(2022\) 11, 114008\]](#)

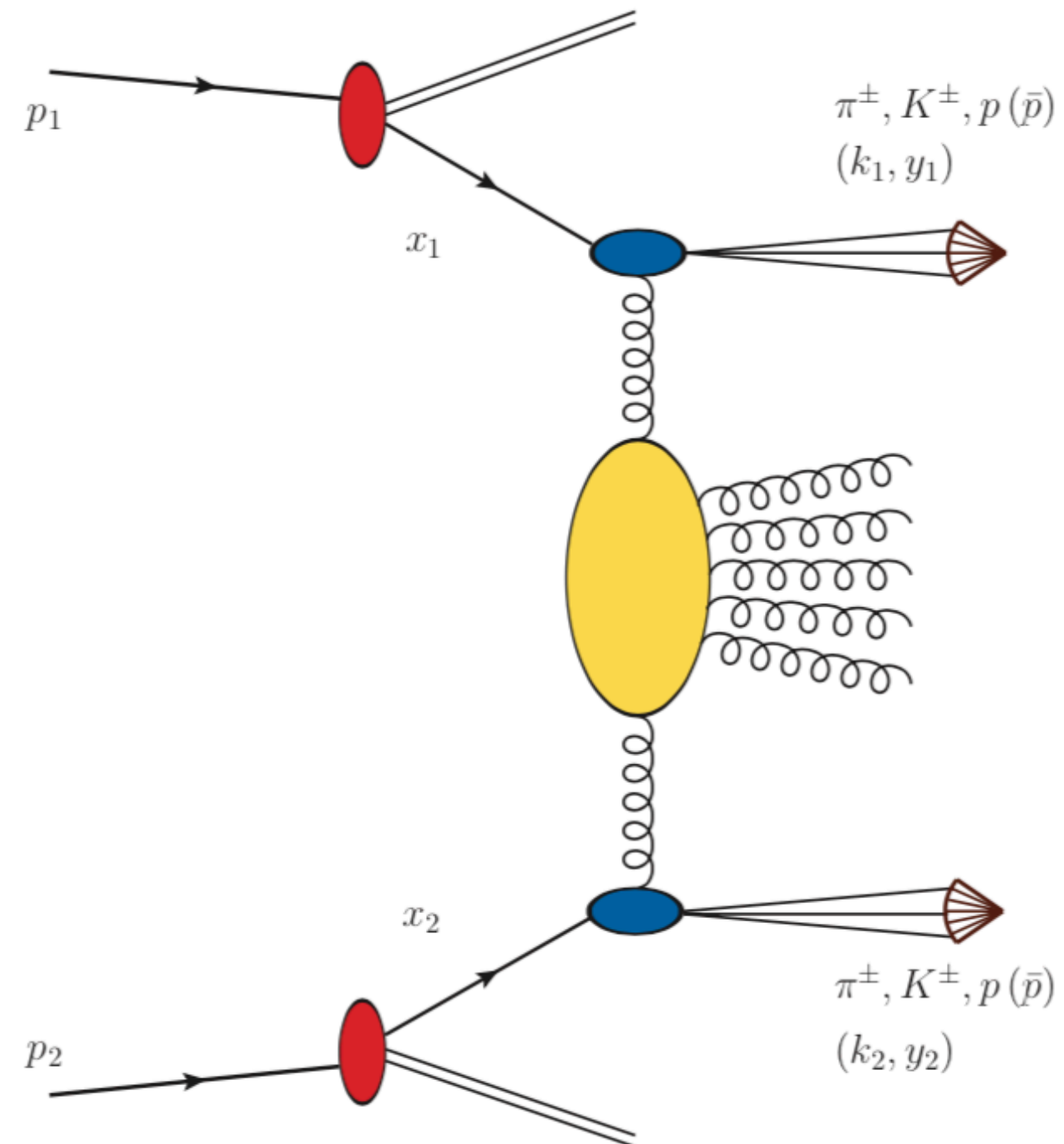
# HEAVY-LIGHT HADRONS

# From Higgs + jet to bound states

## Di-hadron and hadron-jet correlations

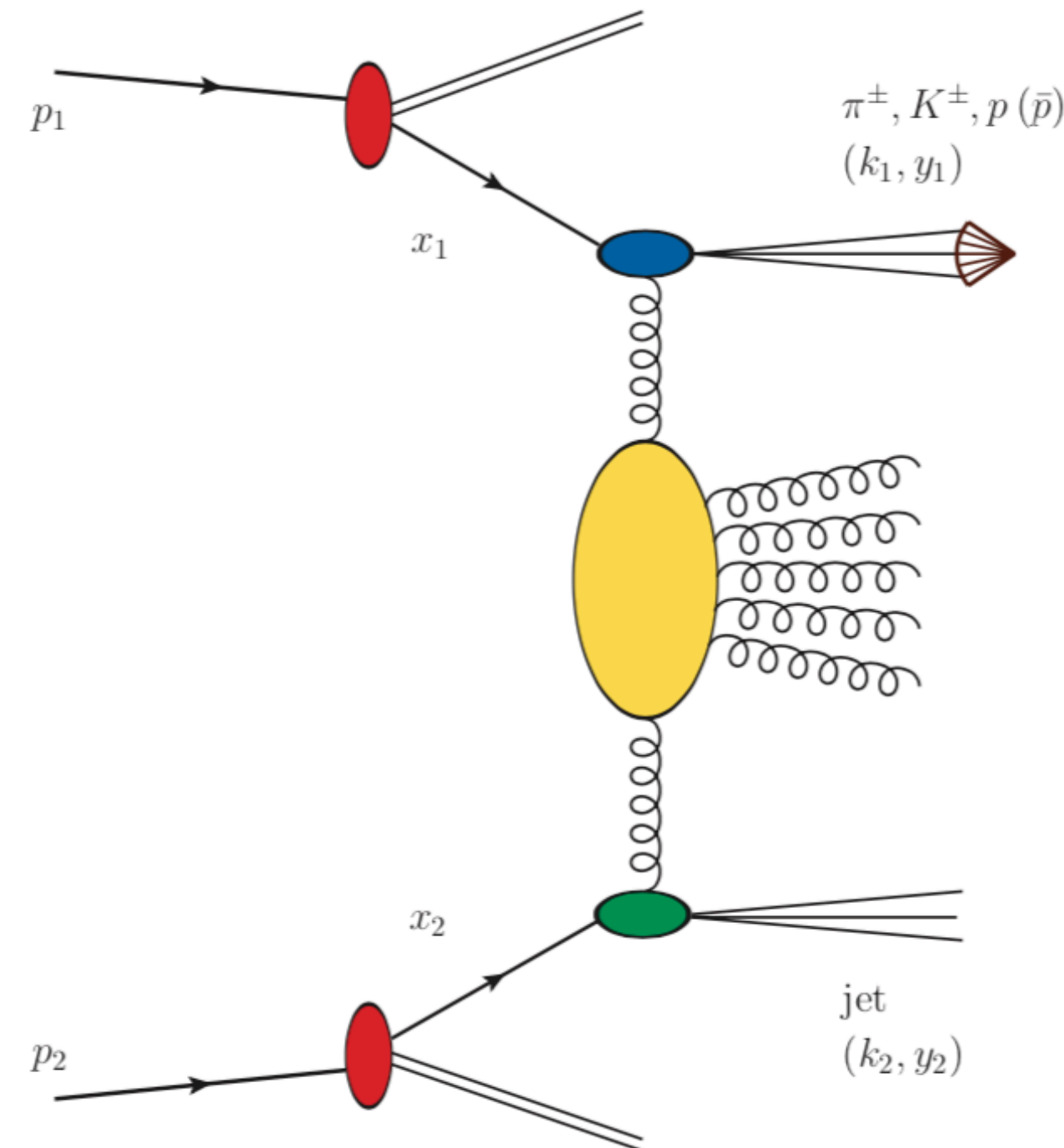
### Inclusive di-hadron production

[D.Yu. Ivanov, A. Papa (2012)] (NLO forward-hadron impact factor)  
[F.G.C., D.Yu. Ivanov, B. Murdaca, A. Papa (2016, 2017)]



### Inclusive hadron-jet production

[A.D. Bolognino, F.G.C., D.Yu. Ivanov, M.M.A. Mohammed, A. Papa (2018)]  
[F.G.C. (in preparation)]



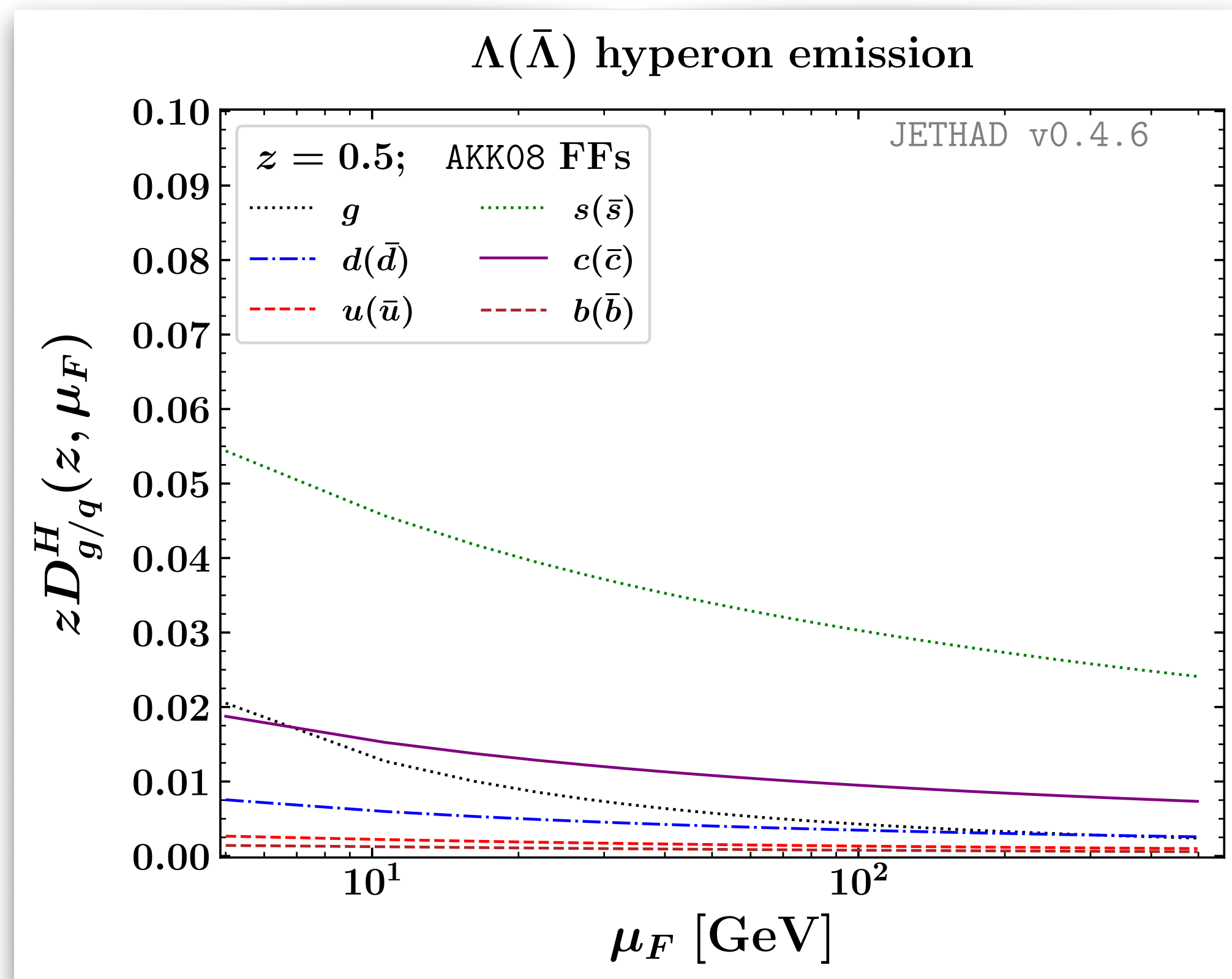
- ◇ NLO impact factors known  $\Rightarrow$  full NLA BFKL analysis feasible
- ◇ PDFs + FFs at work (both), hadrons at smaller rapidities than jets (di-hadron)
- ◇ genuine *asymmetric* cuts in transverse momenta (hadron-jet)

# Stabilizing effects of heavy-flavor fragmentation



**AKK08** VFNS collinear FFs for  $\Lambda$  hyperon:  $|uds\rangle$

[S. Albino et al., Nucl. Phys. B 803 (2008) 42-104]

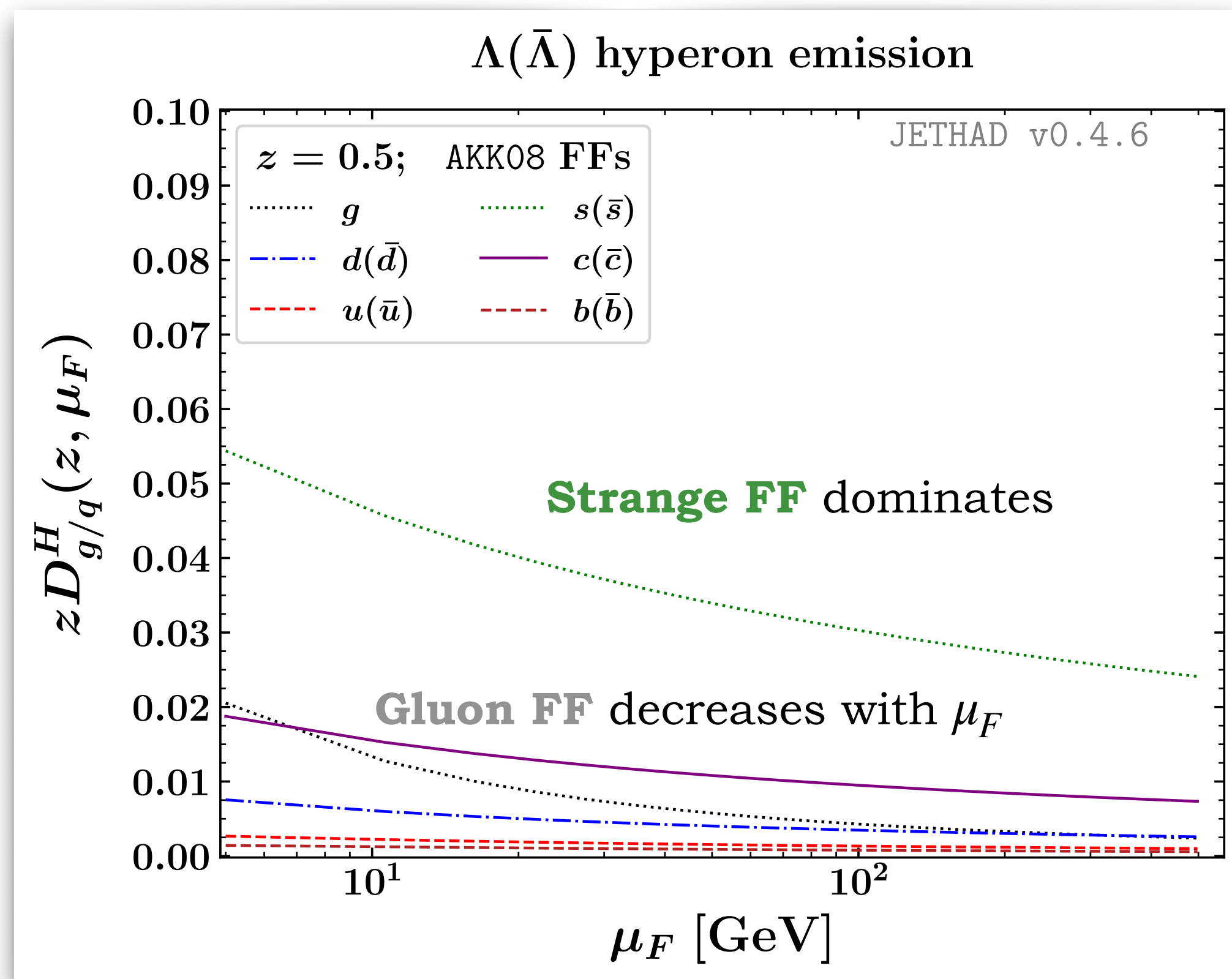


# Stabilizing effects of heavy-flavor fragmentation



AKK08 VFNS collinear FFs for  $\Lambda$  hyperon:  $|uds\rangle$

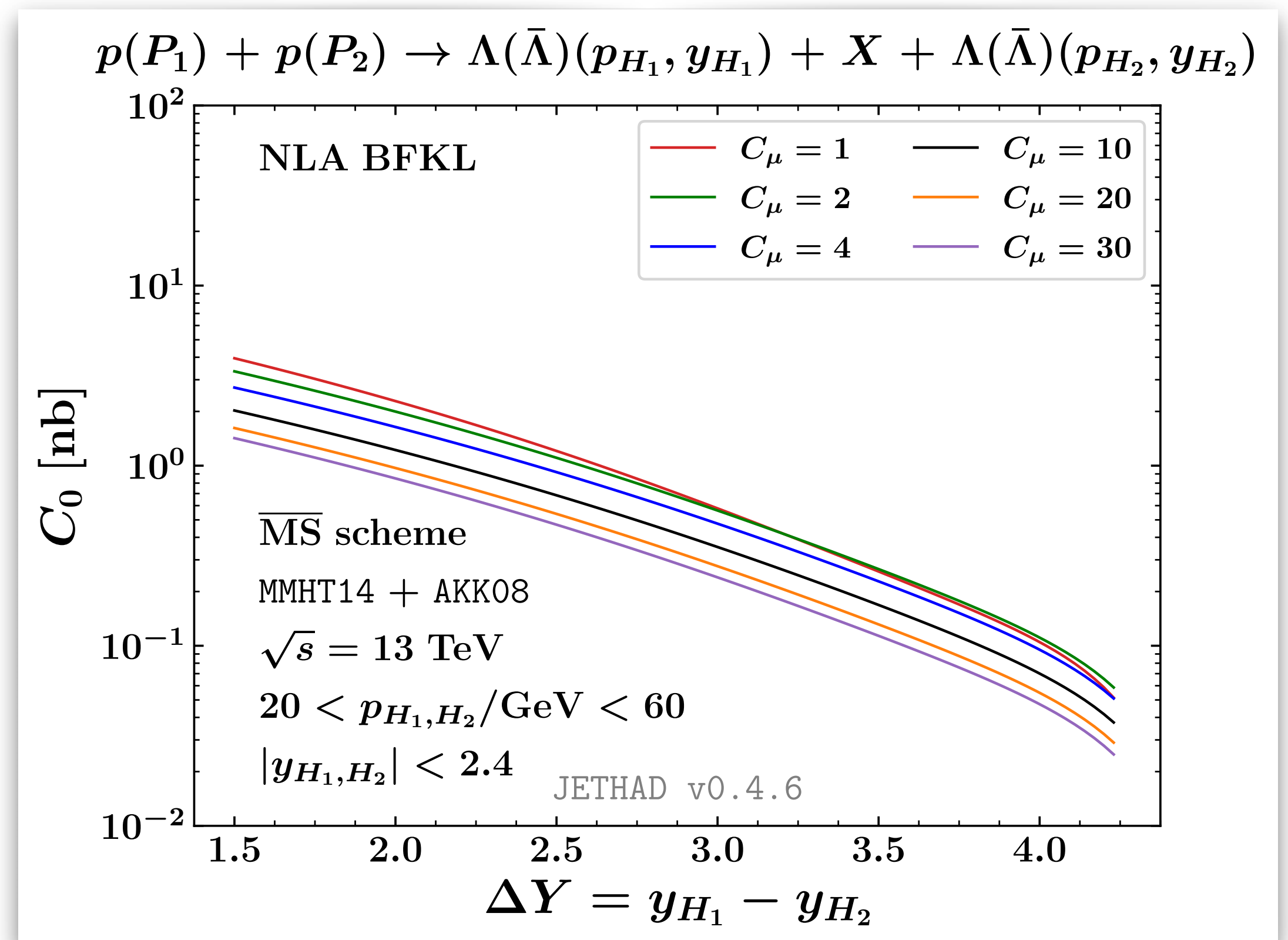
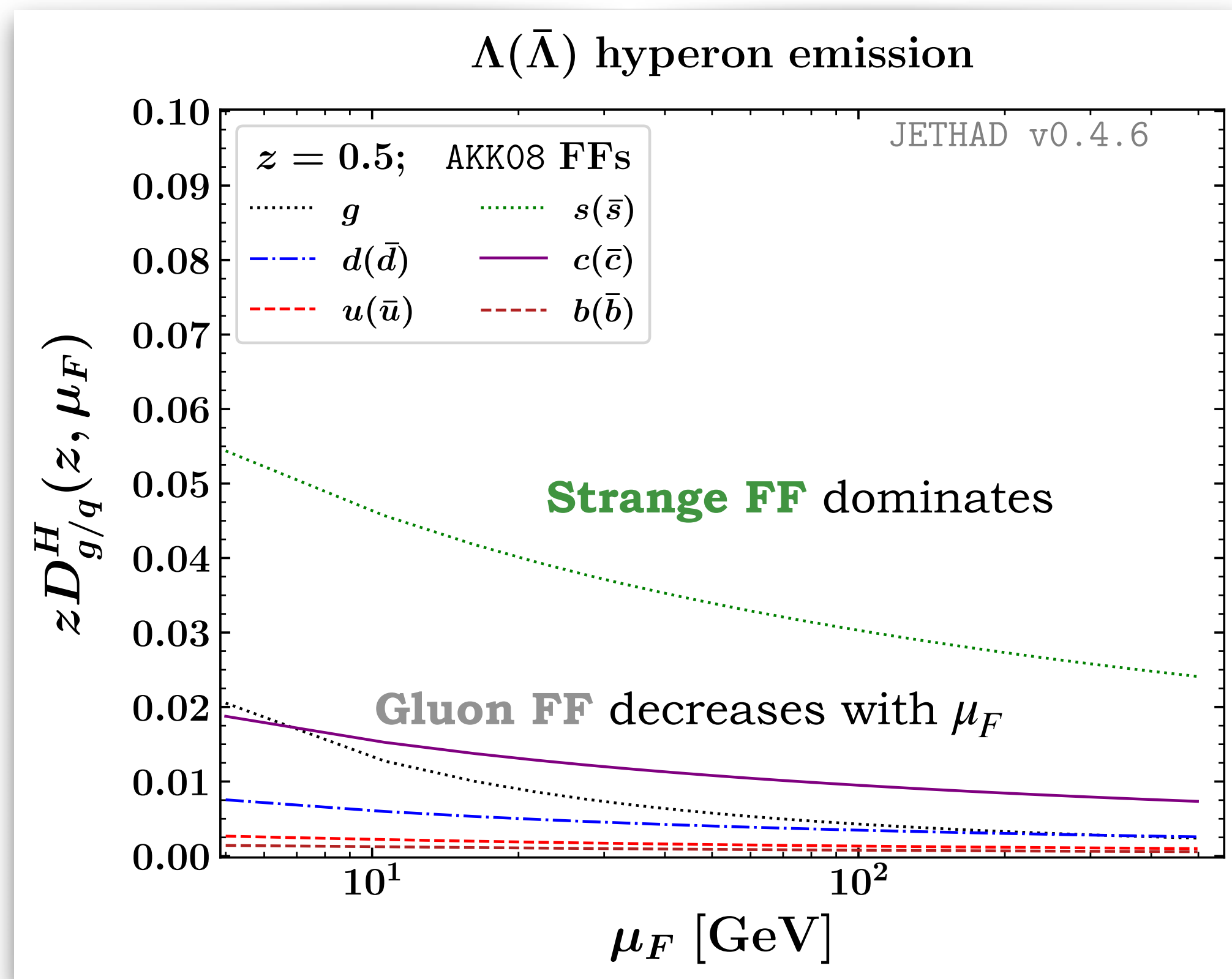
[S. Albino et al., Nucl. Phys. B 803 (2008) 42-104]



# Stabilizing effects of heavy-flavor fragmentation

 **AKK08** VFNS collinear FFs for  $\Lambda$  hyperon:  $|uds\rangle$

 [S. Albino et al., Nucl. Phys. B 803 (2008) 42-104]



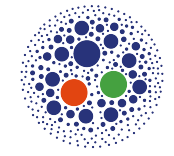
 Rapidity distribution **sensitive** to scale variations

( $\Lambda$  hyperons)  [F. G. C. et al., Phys. Rev. D 102 (2020) 9, 094019]

(cascade  $\Xi$  baryons)  [F. G. C., Eur. Phys. J. C (in press)]

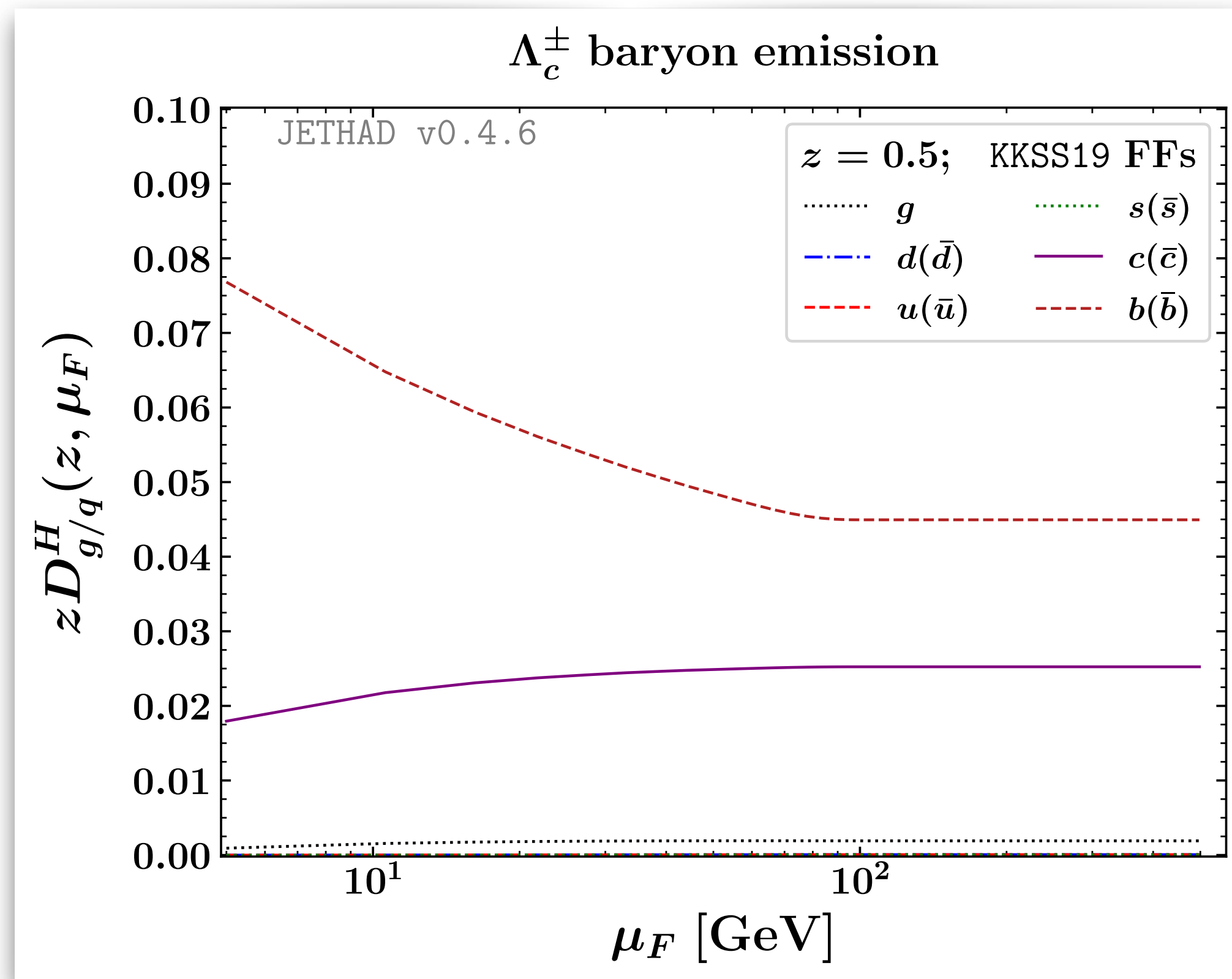


# Stabilizing effects of heavy-flavor fragmentation

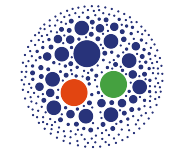


KKSS19 VFNS collinear FFs for  $\Lambda_c$  baryons:  $|udc\rangle$

[\[B. A. Kniehl et al., Phys. Rev. D 101 \(2020\) 11, 114021\]](#)

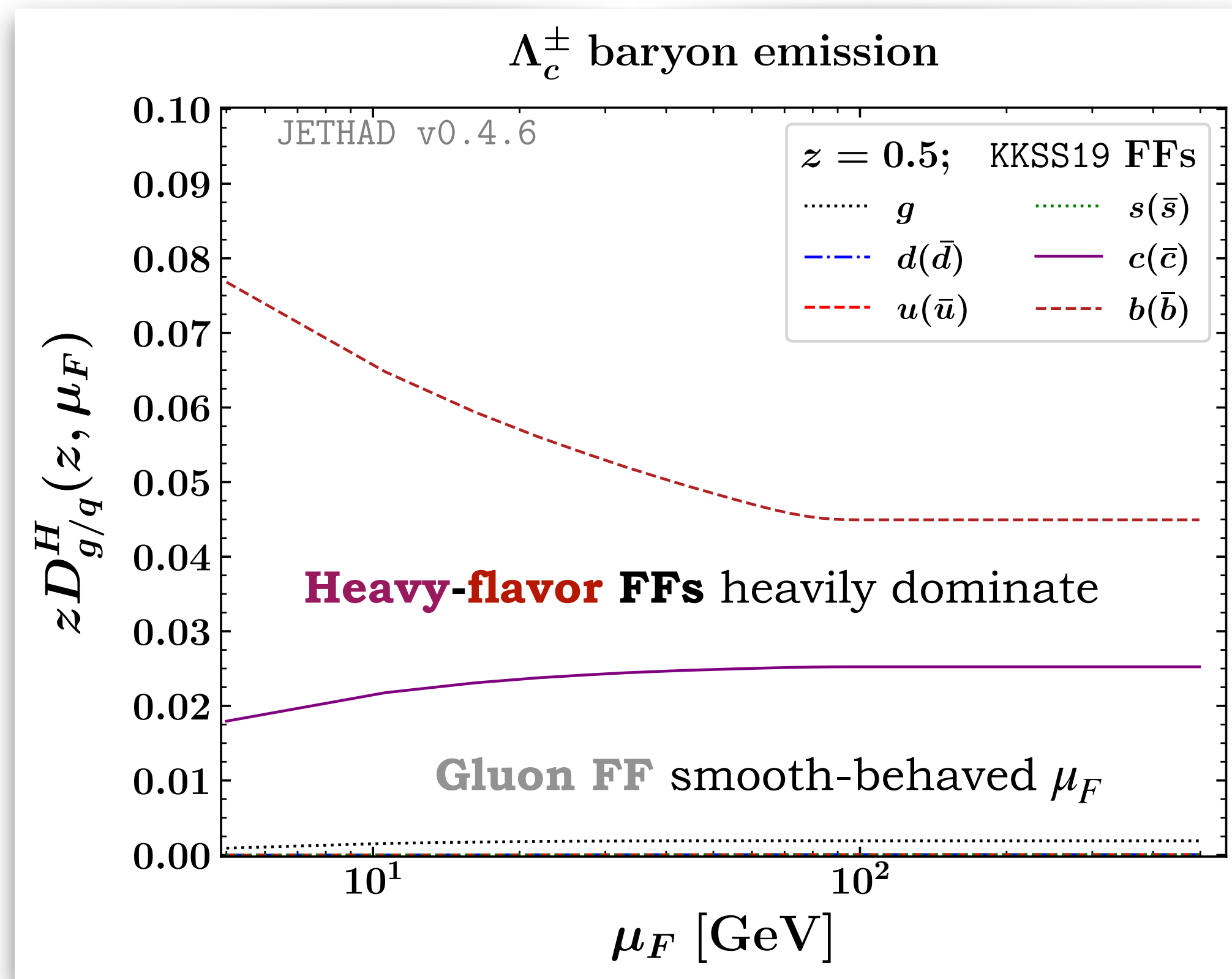


# Stabilizing effects of heavy-flavor fragmentation

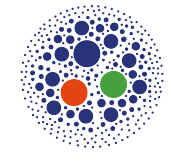


KKSS19 VFNS collinear FFs for  $\Lambda_c$  baryons:  $|udc\rangle$

[\[B. A. Kniehl et al., Phys. Rev. D 101 \(2020\) 11, 114021\]](#)

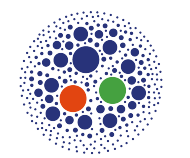
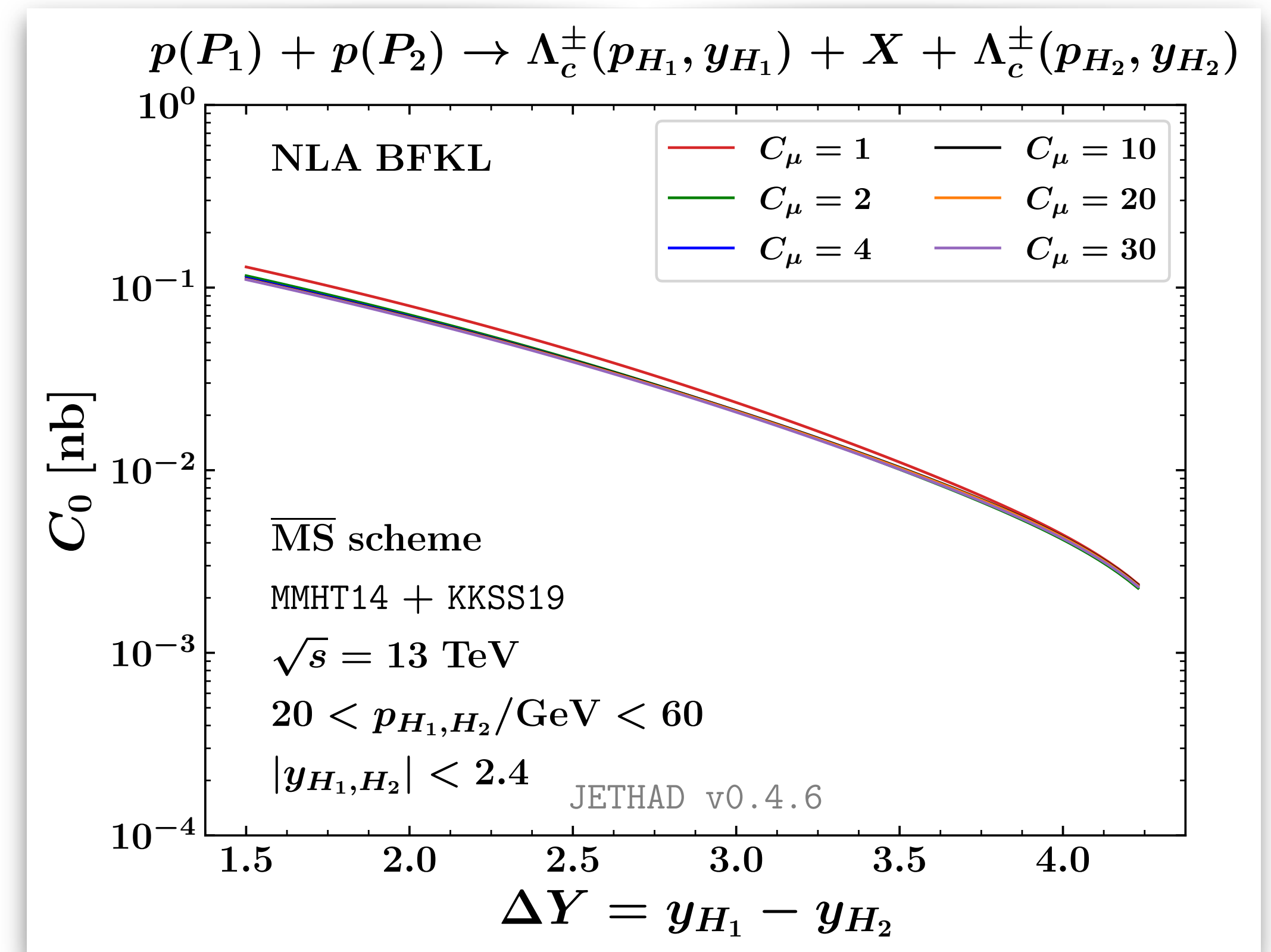
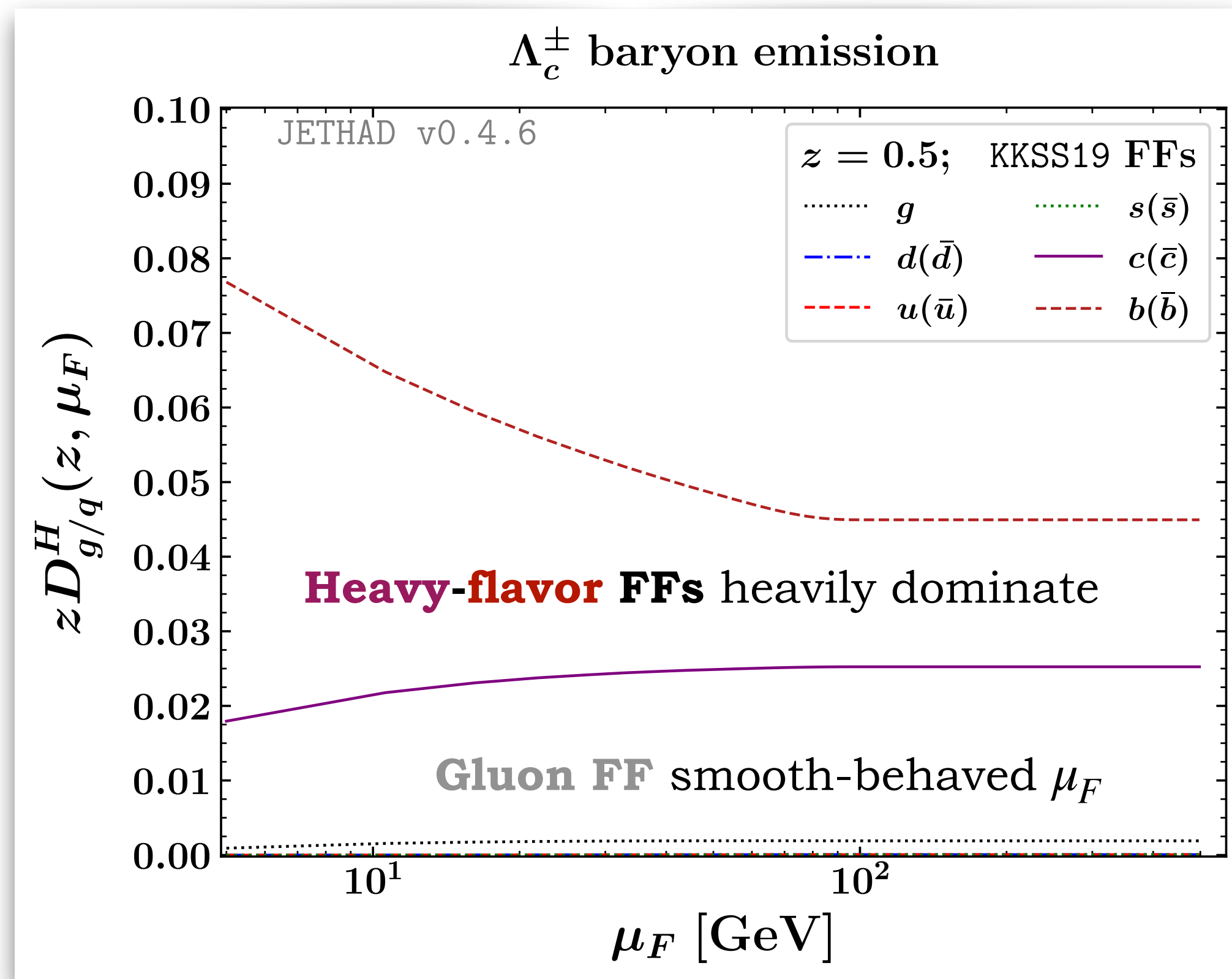


# Stabilizing effects of heavy-flavor fragmentation



KKSS19 VFNS collinear FFs for  $\Lambda_c$  baryons:  $|udc\rangle$

[B. A. Kniehl et al., Phys. Rev. D 101 (2020) 11, 114021]



Rapidity distribution **stable** under scale variations

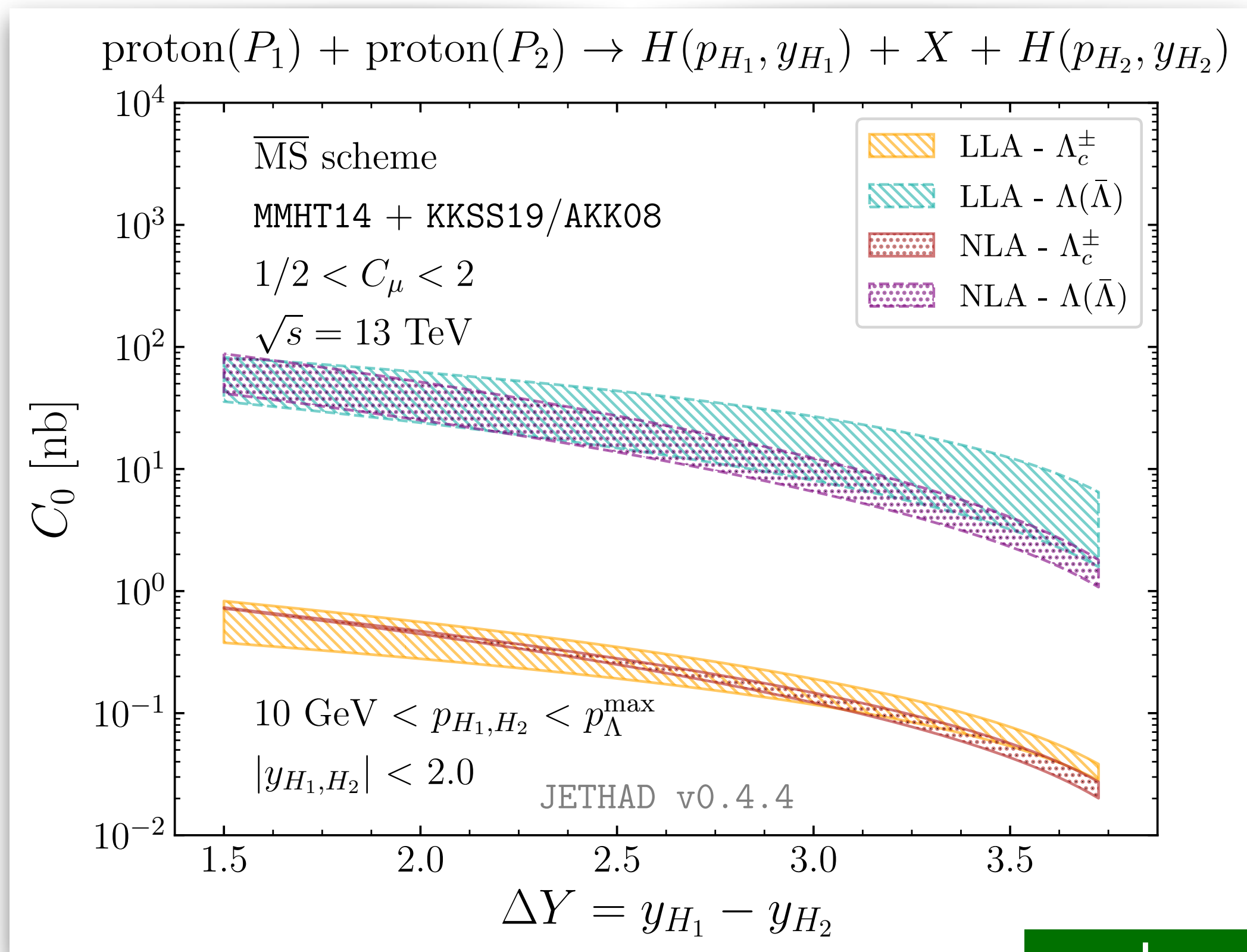
( $B_c^{(*)}$  hadrons) [F. G. C., Phys. Lett. B 835 (2022) 137554]

( $\Lambda_c$  baryons, in this slide) [F. G. C. et al., Eur. Phys. J. C 81 (2021) 8, 780]

( $H_b$  hadrons) [F. G. C. et al., Phys. Rev. D 104 (2021) 11, 114007]

# Stability under scale variations & NLL corrections

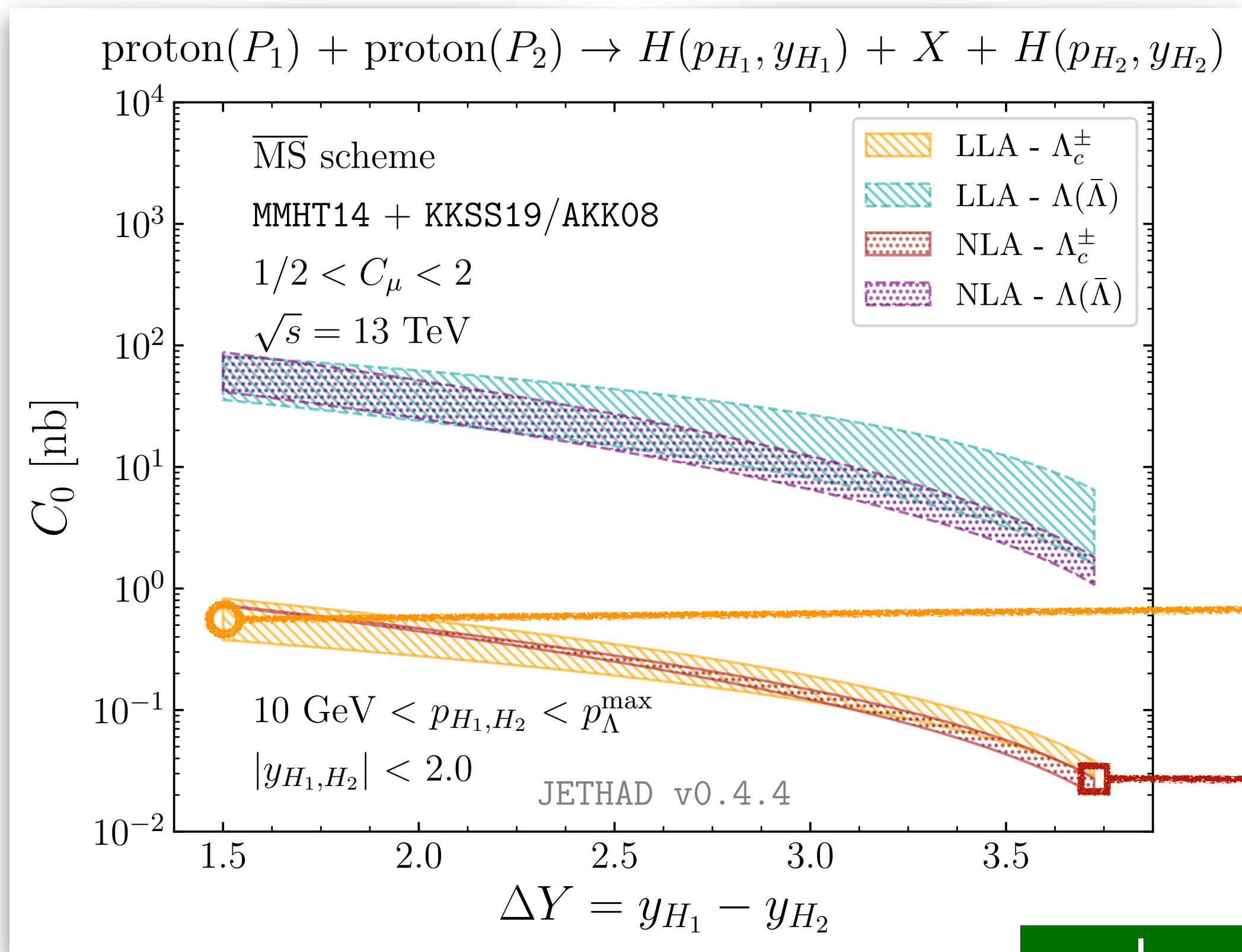
Hybrid factorization @work:  $\Lambda_c$  baryons  $|udc\rangle$  versus  $\Lambda$  hyperons  $|uds\rangle$



natural

# Stability under scale variations & NLL corrections

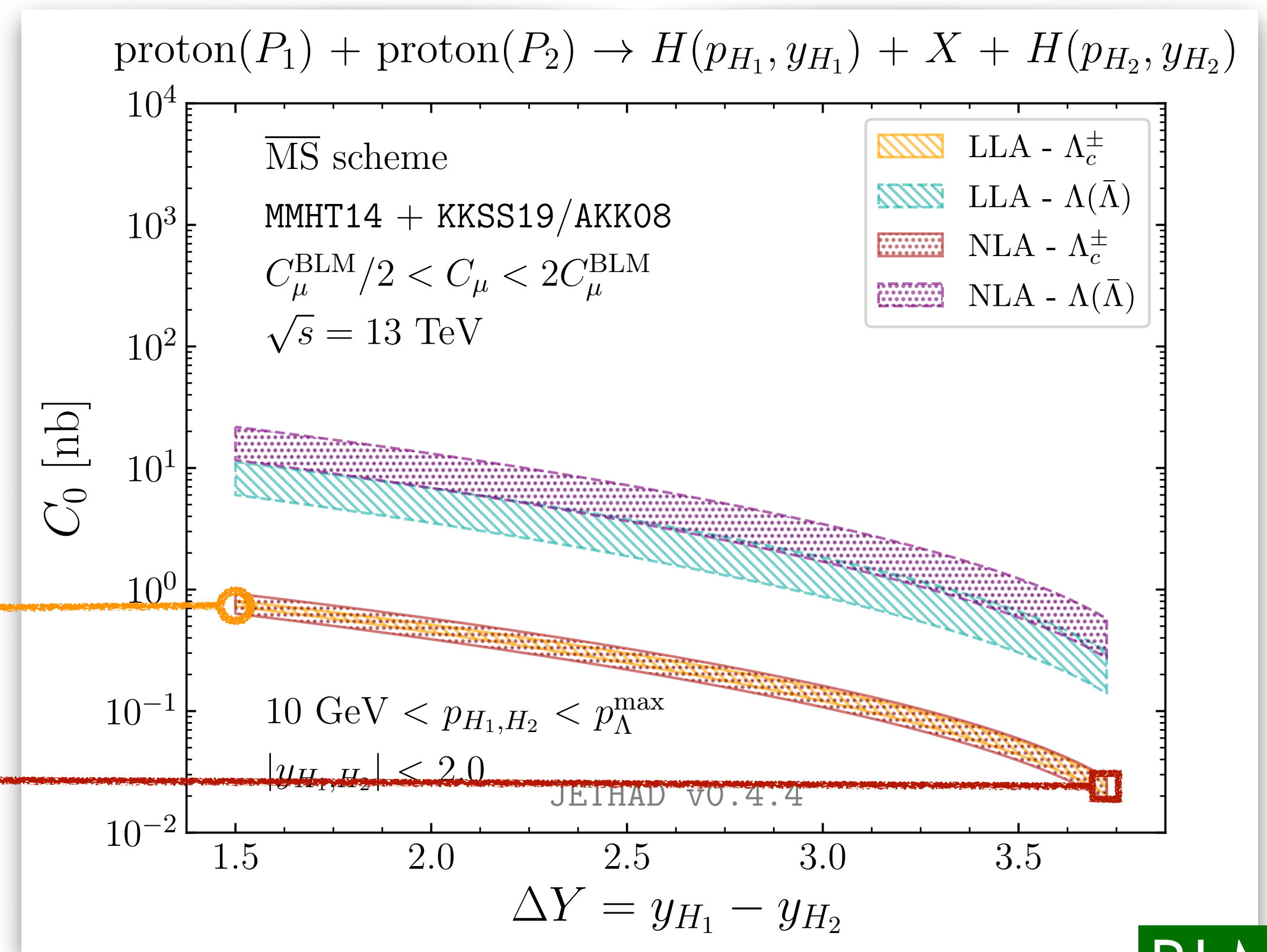
Hybrid factorization @work:  $\Lambda_c$  baryons  $|udc\rangle$  versus  $\Lambda$  hyperons  $|uds\rangle$



LL  $\Lambda_c$

NLL  $\Lambda_c$

natural



BLM

NLL corrections: rapidity distribution **stable** for  $\Lambda_c$

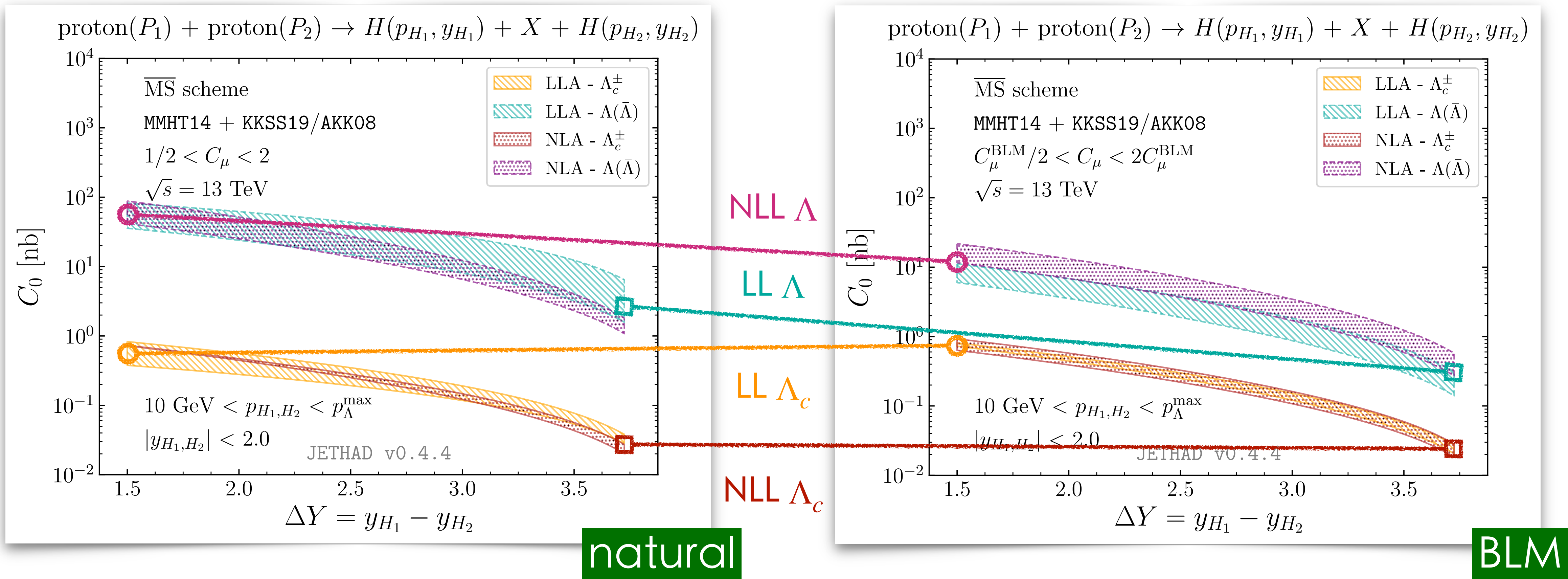
( $\Lambda_c$  baryons, in this slide) [\[F. G. C. et al., Eur. Phys. J. C 81 \(2021\) 8, 780\]](#)

( $H_b$  hadrons) [\[F. G. C. et al., Phys. Rev. D 104 \(2021\) 11, 114007\]](#)

Backup

# Stability under scale variations & NLL corrections

Hybrid factorization @work:  $\Lambda_c$  baryons  $|udc\rangle$  versus  $\Lambda$  hyperons  $|uds\rangle$

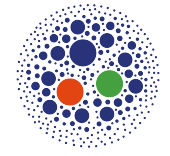


NLL corrections: rapidity distribution **stable** for  $\Lambda_c$ , loses  $\sim 10^1$  magnitude for  $\Lambda$

( $\Lambda_c$  baryons, in this slide) [\[F. G. C. et al., Eur. Phys. J. C 81 \(2021\) 8, 780\]](#)

( $H_b$  hadrons) [\[F. G. C. et al., Phys. Rev. D 104 \(2021\) 11, 114007\]](#)

# Stabilizing effects of heavy-flavor fragmentation

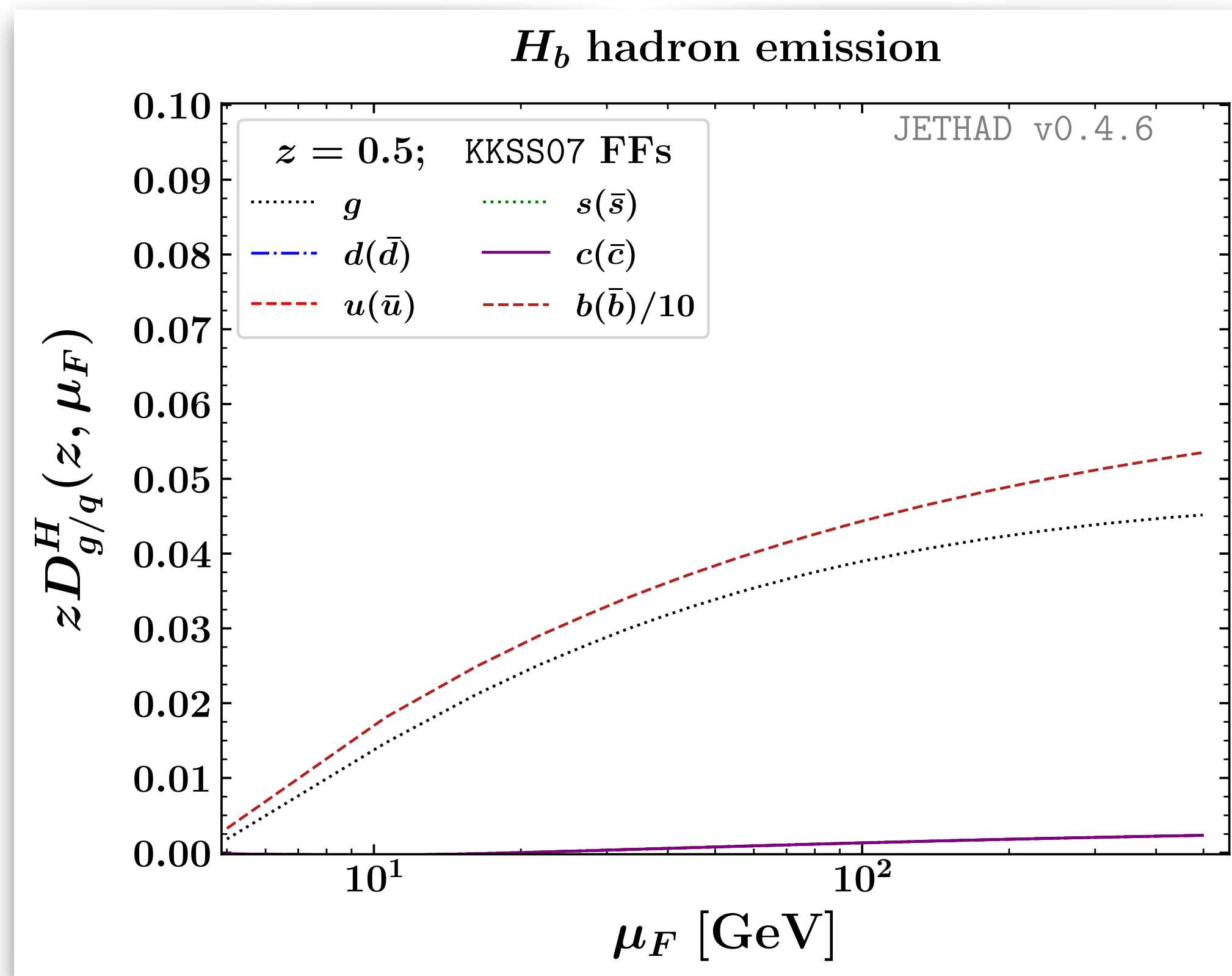


**KKSS07** VFNS collinear FFs for:

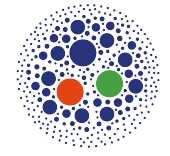
$$H_b = B^\pm, B^0, B_s^0, \Lambda_b$$

[\[B. A. Kniehl, H. Spiesberger, Phys. Rev. D 98 \(2018\) 11, 114010\]](#)

[\[B. A. Kniehl et al., Phys. Rev. D 77 \(2008\) 11, 014011\]](#)



# Stabilizing effects of heavy-flavor fragmentation

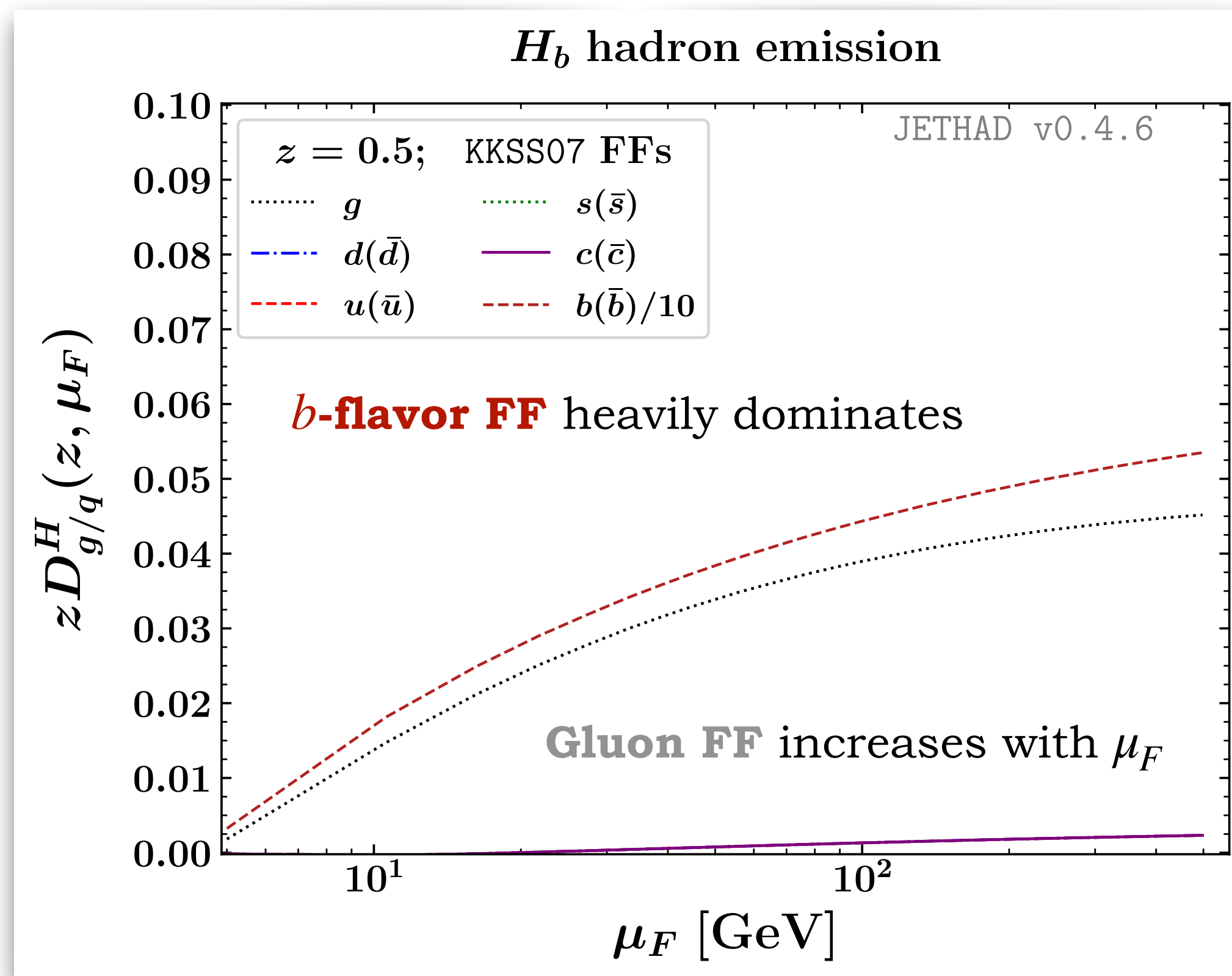


**KKSS07** VFNS collinear FFs for:

$$H_b = B^\pm, B^0, B_s^0, \Lambda_b$$

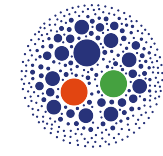
[\[B. A. Kniehl, H. Spiesberger, Phys. Rev. D 98 \(2018\) 11, 114010\]](#)

[\[B. A. Kniehl et al., Phys. Rev. D 77 \(2008\) 11, 014011\]](#)





# Stabilizing effects of heavy-flavor fragmentation

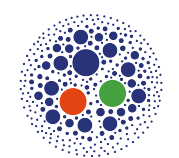
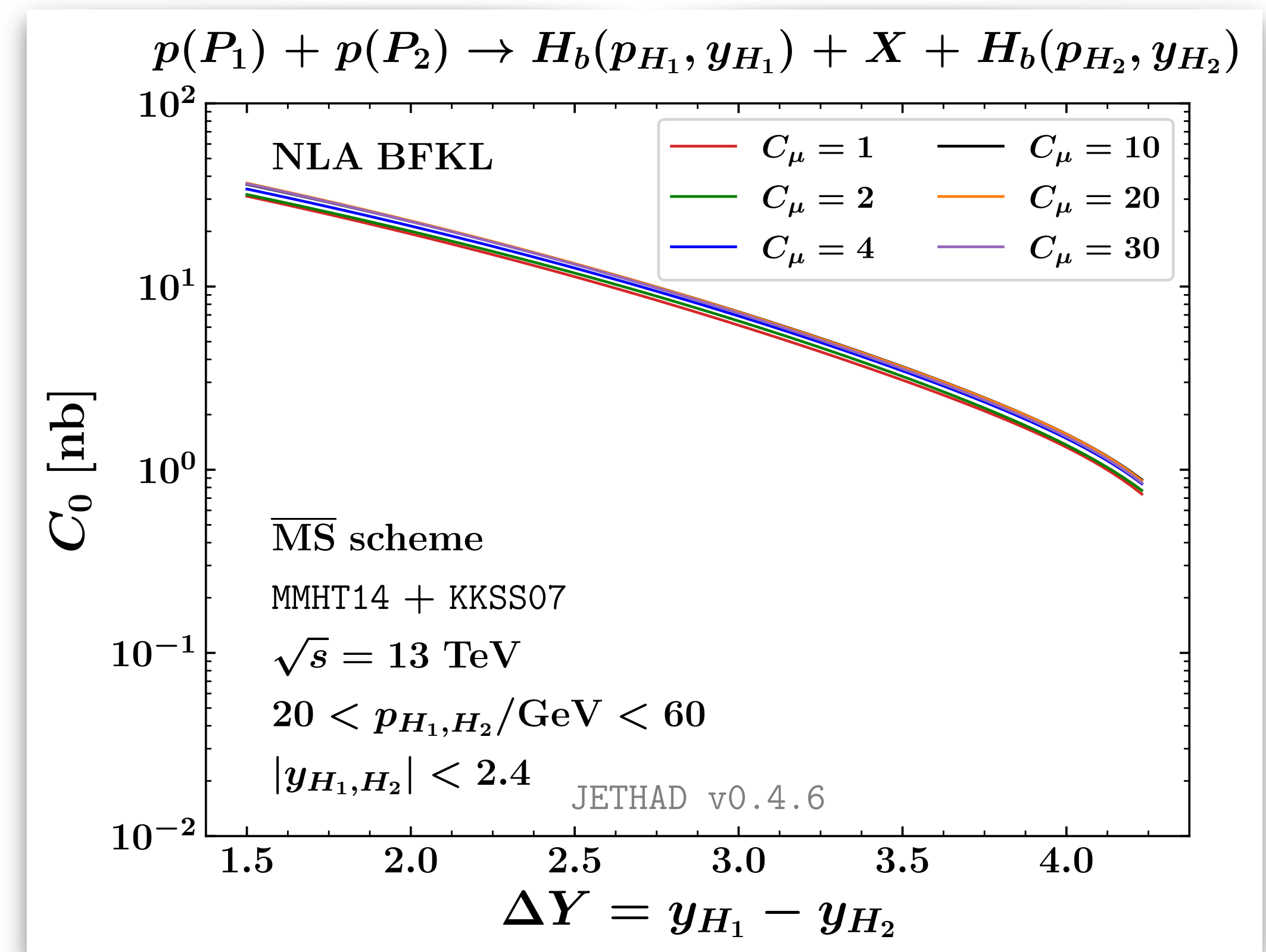
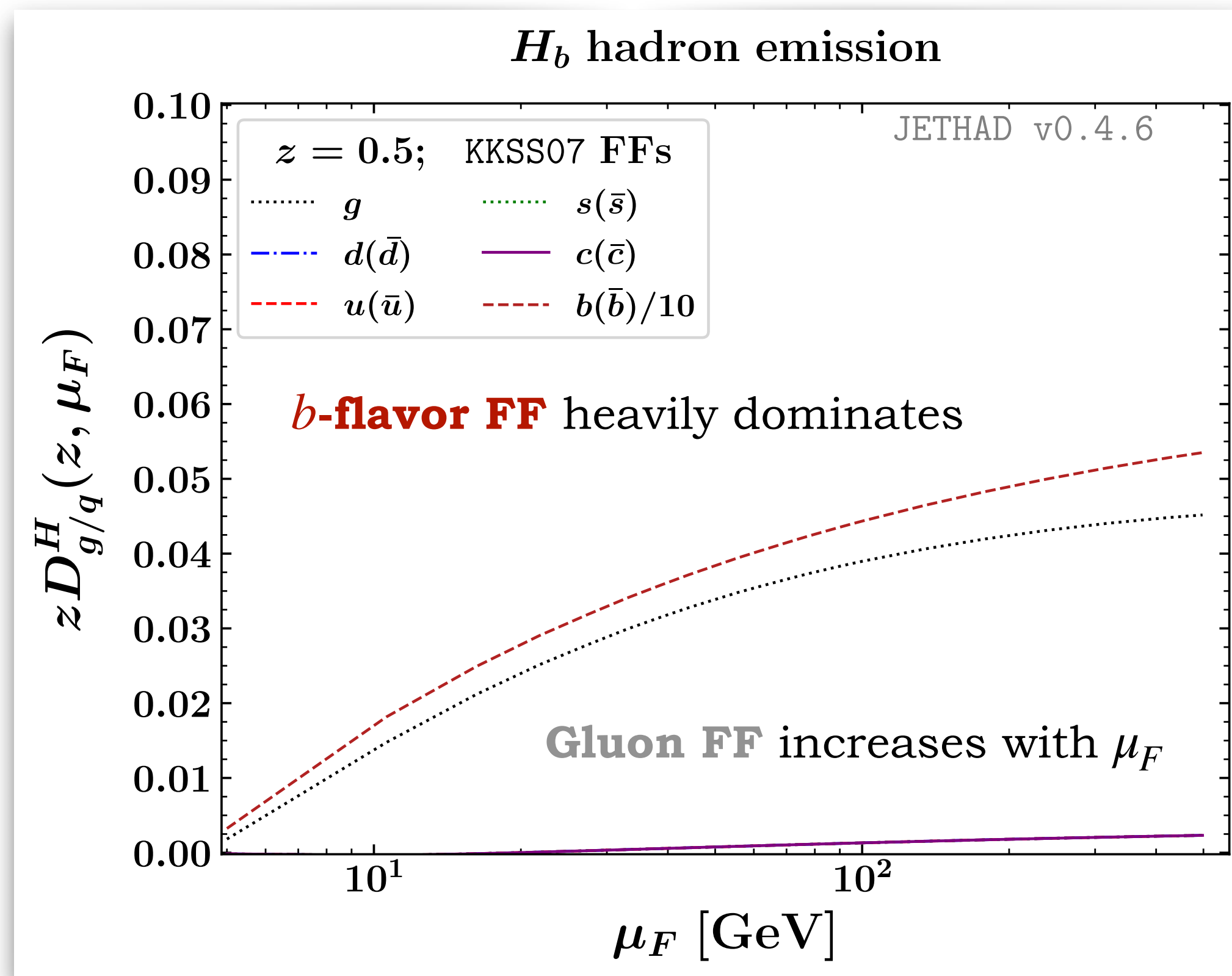


**KKSS07** VFNS collinear FFs for:

$$H_b = B^\pm, B^0, B_s^0, \Lambda_b$$

[\[B. A. Kniehl, H. Spiesberger, Phys. Rev. D 98 \(2018\) 11, 114010\]](#)

[\[B. A. Kniehl et al., Phys. Rev. D 77 \(2008\) 11, 014011\]](#)



Rapidity distribution **very stable** under scale variations

( $H_b$  hadrons, in this slide) [\[F. G. C. et al., Phys. Rev. D 104 \(2021\) 11, 114007\]](#)

( $\Lambda_c$  baryons) [\[F. G. C. et al., Eur. Phys. J. C 81 \(2021\) 8, 780\]](#)

# Stabilizing effects of heavy-flavor fragmentation

 Stabilization mechanism encoded in the heavy-flavor **gluon FF**

 Forward-hadron LO impact factor  $\Rightarrow$  **gluon FF** enhanced by **gluon PDF** in collinear convolution

$$c_{\Lambda}(n, \nu, |\vec{p}|, x) = 2\sqrt{\frac{C_F}{C_A}} (|\vec{p}|^2)^{i\nu-1/2} \int_x^1 \frac{dz}{z} \left(\frac{z}{x}\right)^{2i\nu-1} \left[ \frac{C_A}{C_F} f_g(z) D_g^{\Lambda} \left(\frac{x}{z}\right) + \sum_{a=q, \bar{q}} f_a(z) D_a^{\Lambda} \left(\frac{x}{z}\right) \right]$$

# Stabilizing effects of heavy-flavor fragmentation

Stabilization mechanism encoded in the heavy-flavor **gluon FF**

Forward-hadron LO impact factor  $\Rightarrow$  **gluon FF** enhanced by **gluon PDF** in collinear convolution

$$c_\Lambda(n, \nu, |\vec{p}|, x) = 2\sqrt{\frac{C_F}{C_A}} (|\vec{p}|^2)^{i\nu-1/2} \int_x^1 \frac{dz}{z} \left(\frac{z}{x}\right)^{2i\nu-1} \left[ \frac{C_A}{C_F} f_g(z) D_g^\Lambda\left(\frac{x}{z}\right) + \sum_{a=q,\bar{q}} f_a(z) D_a^\Lambda\left(\frac{x}{z}\right) \right]$$

Forward-hadron NLO impact factor  $\Rightarrow$  a **non-diagonal heavy-flavor** channel open...

$$c_1^{(1)}(n, \nu, |\vec{k}_1|, \alpha_1) = 2\sqrt{\frac{C_F}{C_A}} (\vec{k}_1^2)^{i\nu-\frac{1}{2}} \frac{1}{2\pi} \int_{\alpha_1}^1 \frac{dx}{x} \int_{\frac{\alpha_1}{x}}^1 \frac{d\zeta}{\zeta} \left(\frac{x\zeta}{\alpha_1}\right)^{2i\nu-1}$$

$$\times \left[ \frac{C_A}{C_F} f_g(x) D_g^h\left(\frac{\alpha_1}{x\zeta}\right) C_{gg}(x, \zeta) + \sum_{a=q,\bar{q}} f_a(x) D_a^h\left(\frac{\alpha_1}{x\zeta}\right) C_{qq}(x, \zeta) \right]$$

$$+ \left[ D_g^h\left(\frac{\alpha_1}{x\zeta}\right) \sum_{a=q,\bar{q}} f_a(x) C_{qg}(x, \zeta) + \frac{C_A}{C_F} f_g(x) \sum_{a=q,\bar{q}} D_a^h\left(\frac{\alpha_1}{x\zeta}\right) C_{gq}(x, \zeta) \right]$$

...but  $|C_{gg}| \sim 50 \div 10^4 |C_{gq}|$

# Stabilizing effects of heavy-flavor fragmentation

Stabilization mechanism encoded in the heavy-flavor **gluon FF**

Forward-hadron LO impact factor  $\Rightarrow$  **gluon FF** enhanced by **gluon PDF** in collinear convolution

$$c_{\Lambda}(n, \nu, |\vec{p}|, x) = 2\sqrt{\frac{C_F}{C_A}} (|\vec{p}|^2)^{i\nu-1/2} \int_x^1 \frac{dz}{z} \left(\frac{z}{x}\right)^{2i\nu-1} \left[ \frac{C_A}{C_F} f_g(z) D_g^{\Lambda} \left(\frac{x}{z}\right) + \sum_{a=q,\bar{q}} f_a(z) D_a^{\Lambda} \left(\frac{x}{z}\right) \right]$$

Forward-hadron NLO impact factor  $\Rightarrow$  a **non-diagonal heavy-flavor** channel open...

$$c_1^{(1)}(n, \nu, |\vec{k}_1|, \alpha_1) = 2\sqrt{\frac{C_F}{C_A}} (\vec{k}_1^2)^{i\nu-\frac{1}{2}} \frac{1}{2\pi} \int_{\alpha_1}^1 \frac{dx}{x} \int_{\frac{\alpha_1}{x}}^1 \frac{d\zeta}{\zeta} \left(\frac{x\zeta}{\alpha_1}\right)^{2i\nu-1} \\ \times \left[ \frac{C_A}{C_F} f_g(x) D_g^h \left(\frac{\alpha_1}{x\zeta}\right) C_{gg}(x, \zeta) + \sum_{a=q,\bar{q}} f_a(x) D_a^h \left(\frac{\alpha_1}{x\zeta}\right) C_{qq}(x, \zeta) \right. \\ \left. + D_g^h \left(\frac{\alpha_1}{x\zeta}\right) \sum_{a=q,\bar{q}} f_a(x) C_{qg}(x, \zeta) + \frac{C_A}{C_F} f_g(x) \sum_{a=q,\bar{q}} D_a^h \left(\frac{\alpha_1}{x\zeta}\right) C_{gq}(x, \zeta) \right] \quad \dots \text{but } |C_{gg}| \sim 50 \div 10^4 |C_{gq}|$$

**Gluon FF** rises with energy  $\Rightarrow$  this **compensates** PDF and BFKL kernel decreasing behavior

**VECTOR QUARKONIA**

# Is the natural stability robust?

(1) **KKSS07** and **KKSS19** VFNS collinear FFs share the same extraction technology

⚠ *Might natural stability be related to the given FF determination(s) ?*

# Is the natural stability robust?

(1) **KKSS07** and **KKSS19** VFNS collinear FFs share the same extraction technology

⚠ *Might natural stability be related to the given FF determination(s) ?*

(2) **KKSS07** and **KKSS19** VFNS collinear FFs assume no initial-scale gluon, but evolution-driven

⚠ *Might natural stability be artificially generated by this Ansatz ?*

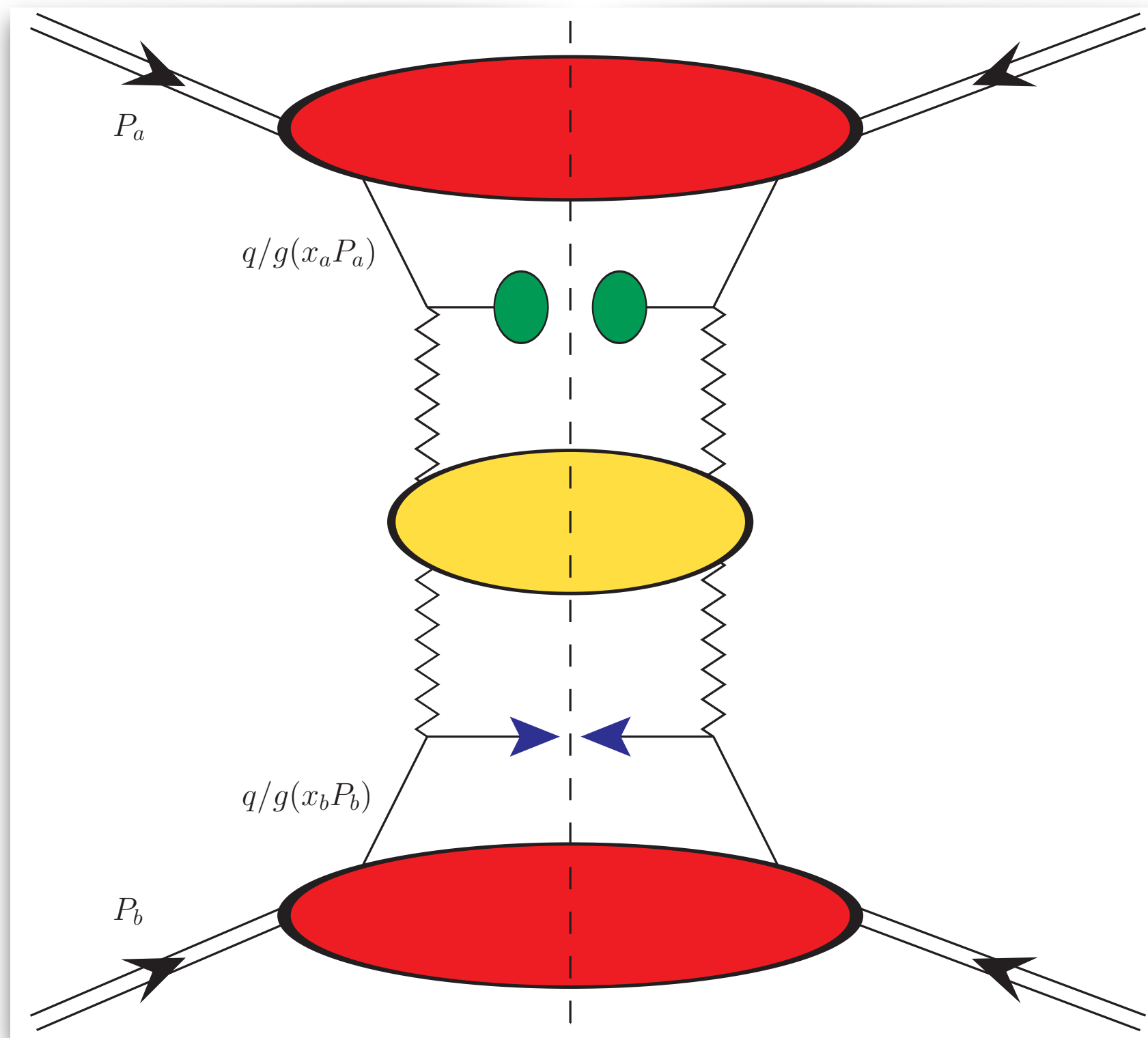
# Vector quarkonium from single-parton fragmentation

(1) ; Let us consider  $J/\psi$  and  $\Upsilon$  at large  $p_T \rightarrow$  single-parton fragmentation from **NRQCD**!



# Vector quarkonium from single-parton fragmentation

(1) **!** Let us consider  $J/\psi$  and  $\Upsilon$  at large  $p_T \rightarrow$  single-parton fragmentation from **NRQCD** !



## 2.1 High-energy resummed cross section

The process under investigation is

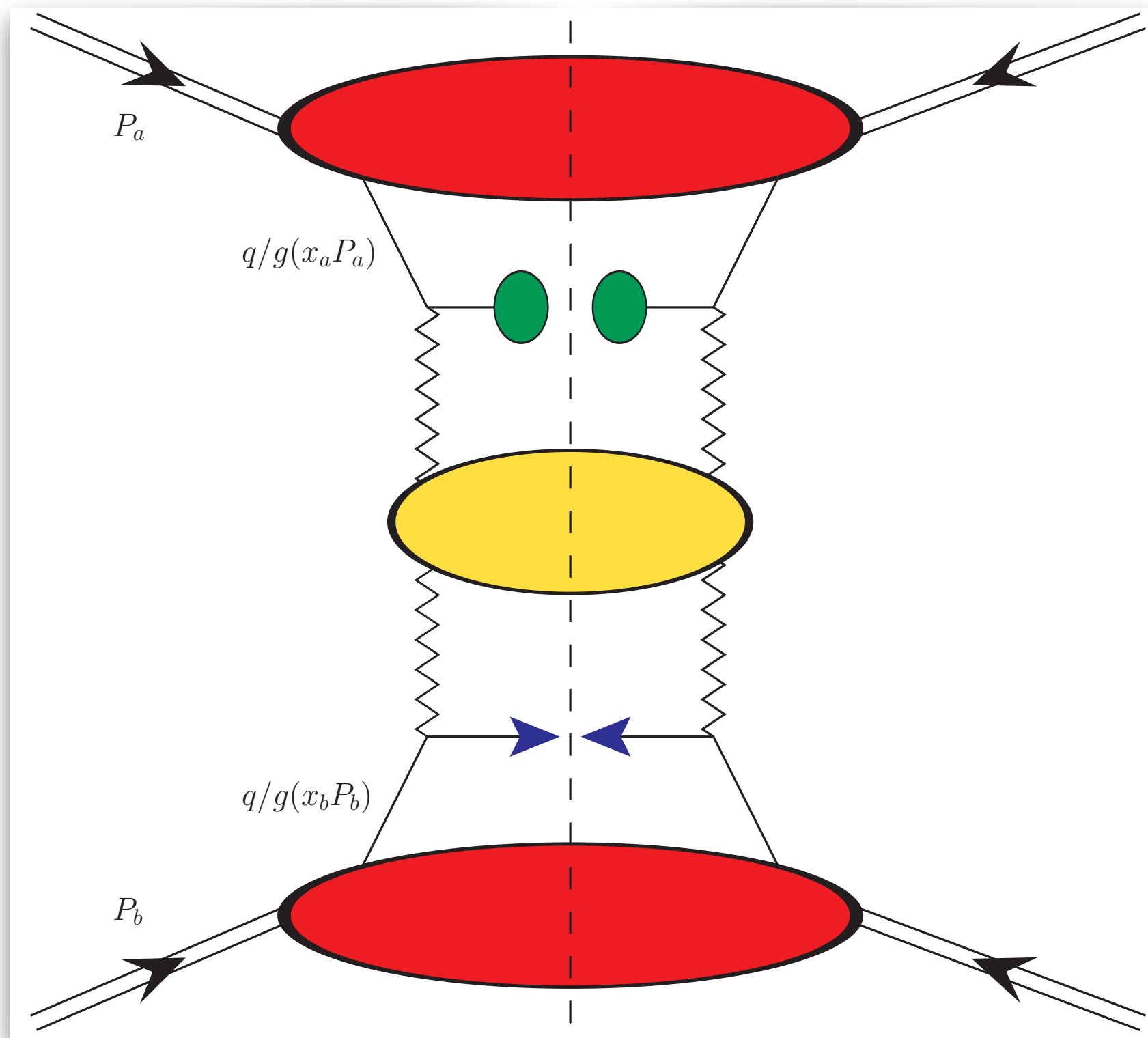
$$p(P_a) + p(P_b) \rightarrow \mathcal{Q}(p_{\mathcal{Q}}, y_{\mathcal{Q}}) + X + \text{jet}(p_J, y_J), \quad (1)$$

where  $p(P_{a,b})$  stands for an initial proton with momentum  $P_{a,b}$ ,  $\mathcal{Q}(p_{\mathcal{Q}}, y_{\mathcal{Q}})$  is a  $J/\psi$  or a  $\Upsilon$  emitted with momentum  $p_{\mathcal{Q}}$  and rapidity  $y_{\mathcal{Q}}$ , the light jet is tagged with momentum  $p_J$  and rapidity  $y_J$ , and  $X$  denotes all the undetected products of the reaction. High observed transverse momenta,  $|\vec{p}_{\mathcal{Q},J}|$ , together with a large rapidity separation,  $\Delta Y = y_{\mathcal{Q}} - y_J$ , are required conditions to get a diffractive semi-hard configuration in the final state. Furthermore the transverse-momentum ranges need to be enough large to ensure the validity of description of the quarkonium production mechanism in terms of single-parton VFNS collinear fragmentation.

[\[F. G. C. et al., Eur. Phys. J. C 82 \(2022\) 10, 929\]](#)

# Vector quarkonium from single-parton fragmentation

(1) **!** Let us consider  $J/\psi$  and  $\Upsilon$  at large  $p_T \rightarrow$  single-parton fragmentation from **NRQCD** !



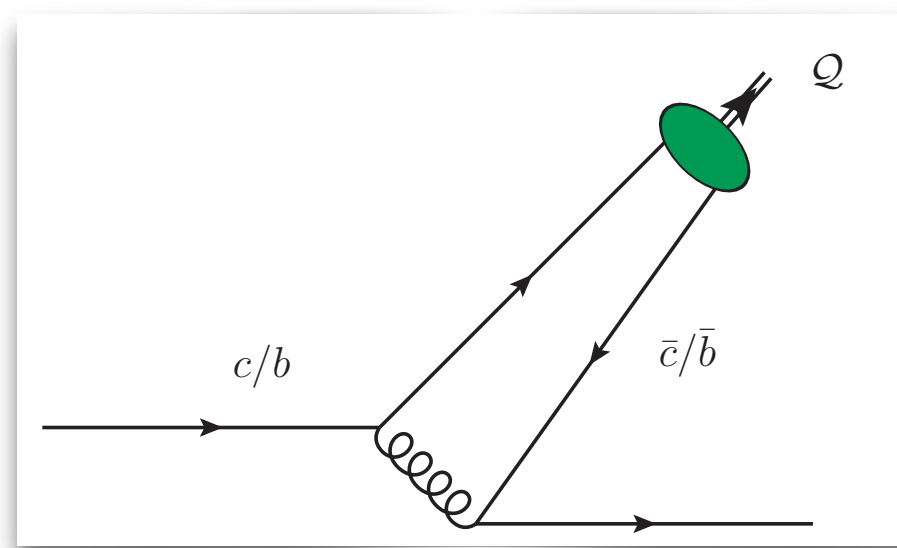
## 2.1 High-energy resummed cross section

The process under investigation is

$$p(P_a) + p(P_b) \rightarrow \mathcal{Q}(p_{\mathcal{Q}}, y_{\mathcal{Q}}) + X + \text{jet}(p_J, y_J), \quad (1)$$

where  $p(P_{a,b})$  stands for an initial proton with momentum  $P_{a,b}$ ,  $\mathcal{Q}(p_{\mathcal{Q}}, y_{\mathcal{Q}})$  is a  $J/\psi$  or a  $\Upsilon$  emitted with momentum  $p_{\mathcal{Q}}$  and rapidity  $y_{\mathcal{Q}}$ , the light jet is tagged with momentum  $p_J$  and rapidity  $y_J$ , and  $X$  denotes all the undetected products of the reaction. High observed transverse momenta,  $|\vec{p}_{\mathcal{Q},J}|$ , together with a large rapidity separation,  $\Delta Y = y_{\mathcal{Q}} - y_J$ , are required conditions to get a diffractive semi-hard configuration in the final state. Furthermore the transverse-momentum ranges need to be enough large to ensure the validity of description of the quarkonium production mechanism in terms of single-parton VFNS collinear fragmentation.

[\[F. G. C. et al., Eur. Phys. J. C 82 \(2022\) 10, 929\]](#)

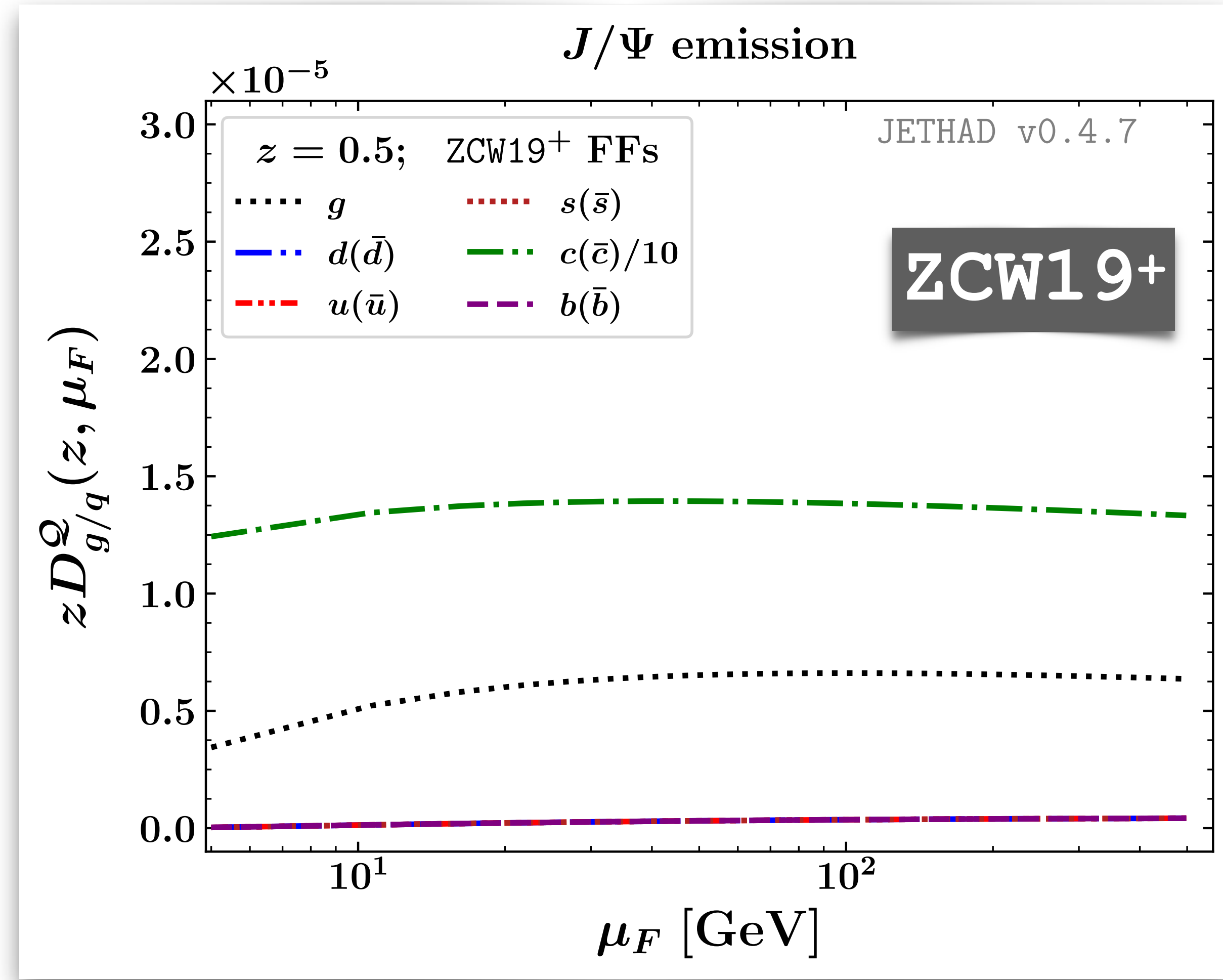
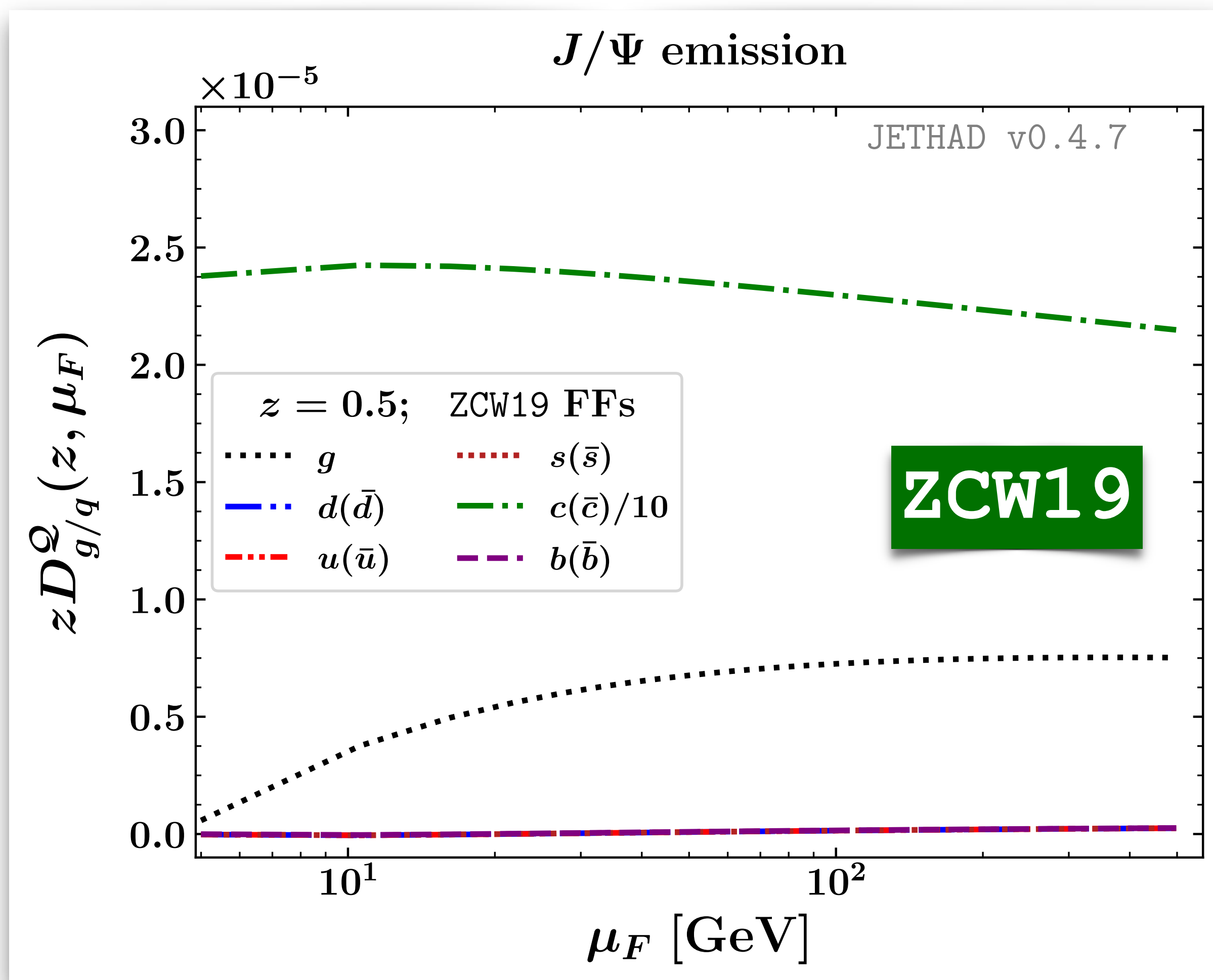


(LO) [\[E. Braaten et al., Phys. Rev. D 48 \(1993\) 4230-4235\]](#)

(NLO) [\[X. Zheng et al., Phys. Rev. D 100 \(2019\) 1, 014005\]](#)

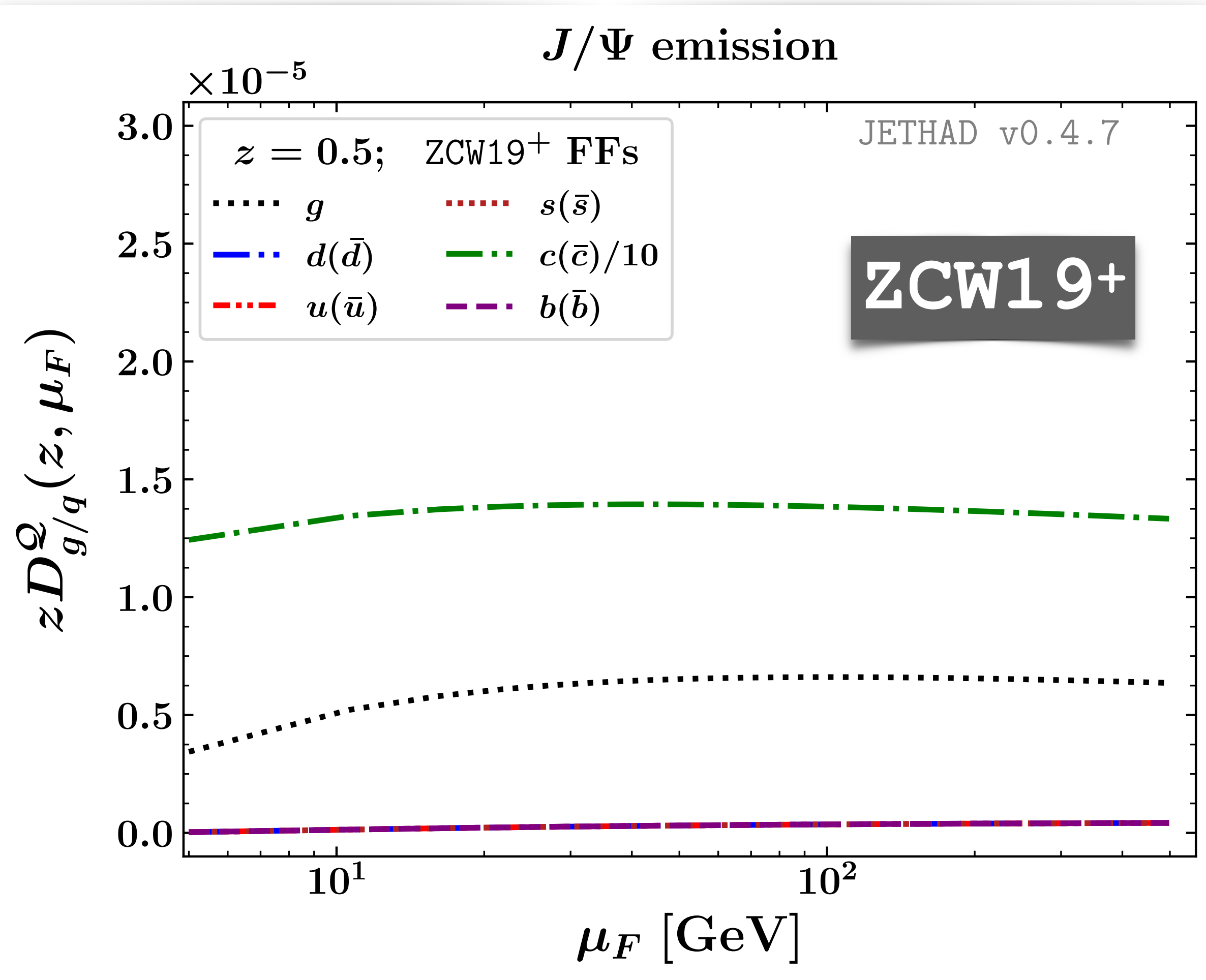
# Vector quarkonium + jet at the LHC

## $J/\psi$ collinear FFs



# Vector quarkonium + jet at the LHC

## $J/\psi$ collinear FFs



## $\Upsilon$ collinear FFs

